



REGIONALNO CS KADETI

Niš, 05.02.2022.

KADETI
-50KG
5 takmičara

TAKMIČAR I KLUB	1	2	3	4	5	POBEDA	BODOVA	MESTO
1 NEŠIĆ, Dalibor Bor, Bor	---	0	10	10	10	3	30	2
2 LOŽAJIĆ, Ilija Vuk, Niš	10	---	10	10	10	4	40	1
3 MIHAILOVIĆ, Vukašin Partizan, Kraljevo	0	0	---	0	0	0	0	5
4 MIHAILOVIĆ, Velimir Partizan, Kraljevo	0	0	10	---	0	1	10	3
5 PRŠIĆ, David Župa Aleksandrovac, Aleksandrovac	0	0	10	10	---	2	20	3

NEŠIĆ, Dalibor	BOR	1	LOŽAJIĆ, Ilija
LOŽAJIĆ, Ilija	VUK		Vuk, Niš
MIHAILOVIĆ, Vukašin	PKR	2	MIHAILOVIĆ, Velimir
MIHAILOVIĆ, Velimir	PKR		Partizan, Kraljevo
NEŠIĆ, Dalibor	BOR	3	NEŠIĆ, Dalibor
PRŠIĆ, David	ŽAL		Bor, Bor
LOŽAJIĆ, Ilija	VUK	4	LOŽAJIĆ, Ilija
MIHAILOVIĆ, Vukašin	PKR		Vuk, Niš
MIHAILOVIĆ, Velimir	PKR	5	PRŠIĆ, David
PRŠIĆ, David	ŽAL		Župa Aleksandrovac, Aleksandrovac
NEŠIĆ, Dalibor	BOR	6	NEŠIĆ, Dalibor
MIHAILOVIĆ, Vukašin	PKR		Bor, Bor
LOŽAJIĆ, Ilija	VUK	7	LOŽAJIĆ, Ilija
MIHAILOVIĆ, Velimir	PKR		Vuk, Niš
MIHAILOVIĆ, Vukašin	PKR	8	PRŠIĆ, David
PRŠIĆ, David	ŽAL		Župa Aleksandrovac, Aleksandrovac
NEŠIĆ, Dalibor	BOR	9	NEŠIĆ, Dalibor
MIHAILOVIĆ, Velimir	PKR		Bor, Bor
LOŽAJIĆ, Ilija	VUK	10	LOŽAJIĆ, Ilija
PRŠIĆ, David	ŽAL		Vuk, Niš

Rezultati

- | | |
|------------------------|-----|
| 1. LOŽAJIĆ, Ilija | VUK |
| 2. NEŠIĆ, Dalibor | BOR |
| 3. PRŠIĆ, David | ŽAL |
| 3. MIHAILOVIĆ, Velimir | PKR |
| 5. MIHAILOVIĆ, Vukašin | PKR |



REGIONALNO CS KADETI

Niš, 05.02.2022.

KADETI
-55KG
8 takmičara

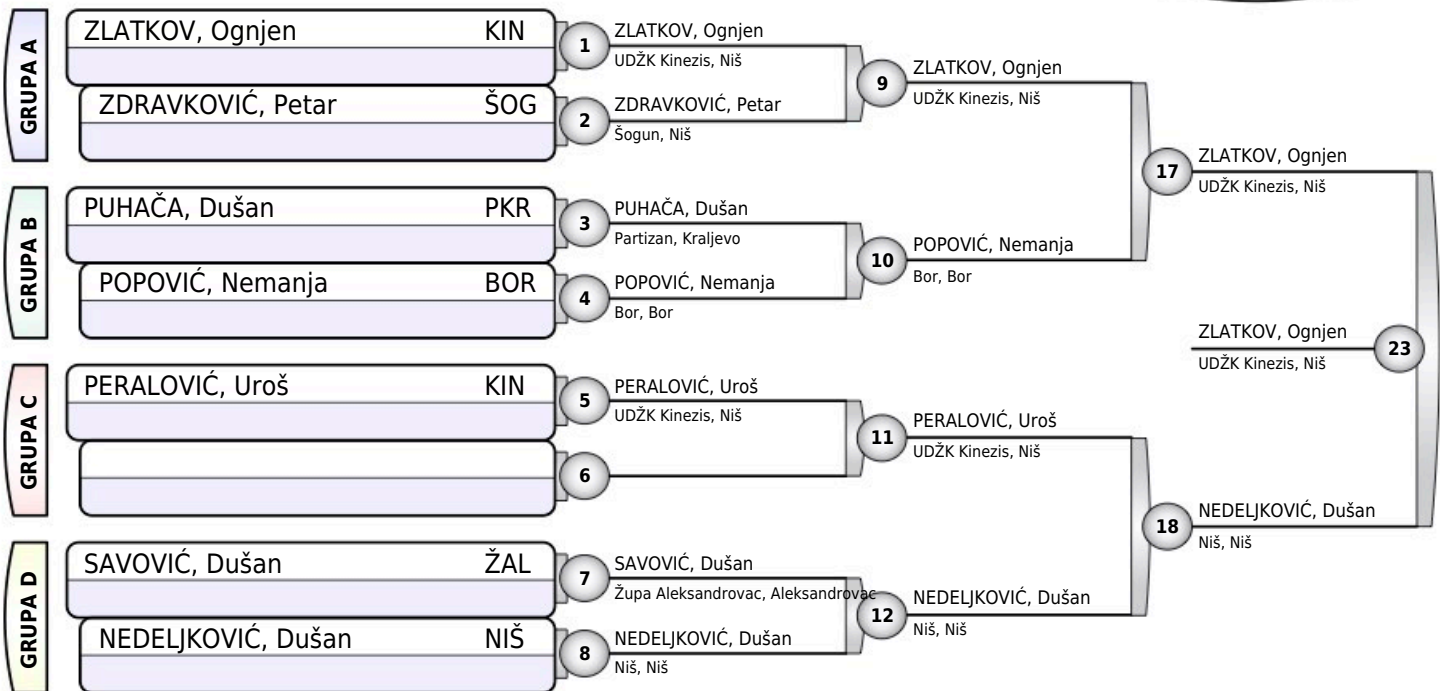

Rezultati

1. ZLATKOV, Ognjen KIN
2. NEDELJKOVIĆ, Dušan NIŠ
3. PERALOVIĆ, Uroš KIN
3. SAVOVIĆ, Dušan ŽAL
5. ZDRAVKOVIĆ, Petar ŠOG
5. POPOVIĆ, Nemanja BOR
7. PUHAČA, Dušan PKR
- 7.

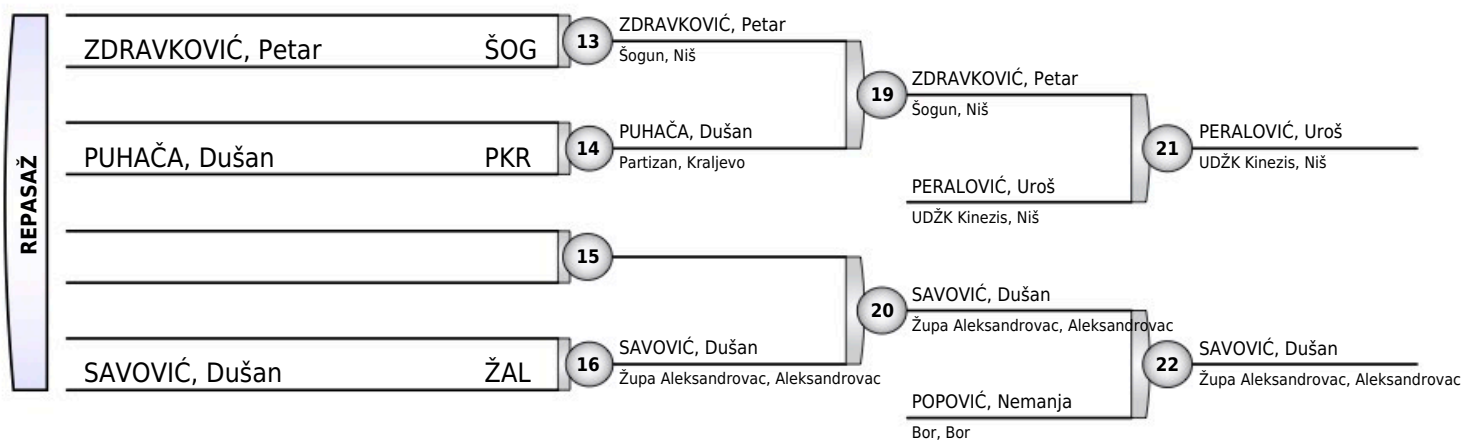



REGIONALNO CS KADETI

Niš, 05.02.2022.

KADETI
-60KG
4 takmičara

TAKMIČAR I KLUB	1	2	3	4	POBEDA	BODOVA	MESTO
1 MLADENOVIĆ, Andrija UDŽK Kinezis, Niš		0	0	0	0	0	3
2 SIMIĆ, Veljko UDŽK Kinezis, Niš	10		0	0	1	10	3
3 SIMIĆ, Ognjen UDŽK Kinezis, Niš	10	10		10	3	30	1
4 LUKIĆ, Mateja 13. maj, Ub	10	10	0		2	20	2

MLADENOVIĆ, Andrija	KIN	1	SIMIĆ, Veljko
SIMIĆ, Veljko	KIN		UDŽK Kinezis, Niš
SIMIĆ, Ognjen	KIN	2	SIMIĆ, Ognjen
LUKIĆ, Mateja	13U		UDŽK Kinezis, Niš
MLADENOVIĆ, Andrija	KIN	3	SIMIĆ, Ognjen
SIMIĆ, Ognjen	KIN		UDŽK Kinezis, Niš
SIMIĆ, Veljko	KIN	4	LUKIĆ, Mateja
LUKIĆ, Mateja	13U		13. maj, Ub
MLADENOVIĆ, Andrija	KIN	5	LUKIĆ, Mateja
LUKIĆ, Mateja	13U		13. maj, Ub
SIMIĆ, Veljko	KIN	6	SIMIĆ, Ognjen
SIMIĆ, Ognjen	KIN		UDŽK Kinezis, Niš

Rezultati

1. SIMIĆ, Ognjen KIN
2. LUKIĆ, Mateja 13U
3. SIMIĆ, Veljko KIN
3. MLADENOVIĆ, Andrija KIN



REGIONALNO CS KADETI

Niš, 05.02.2022.

KADETI

-66KG

11 takmičara

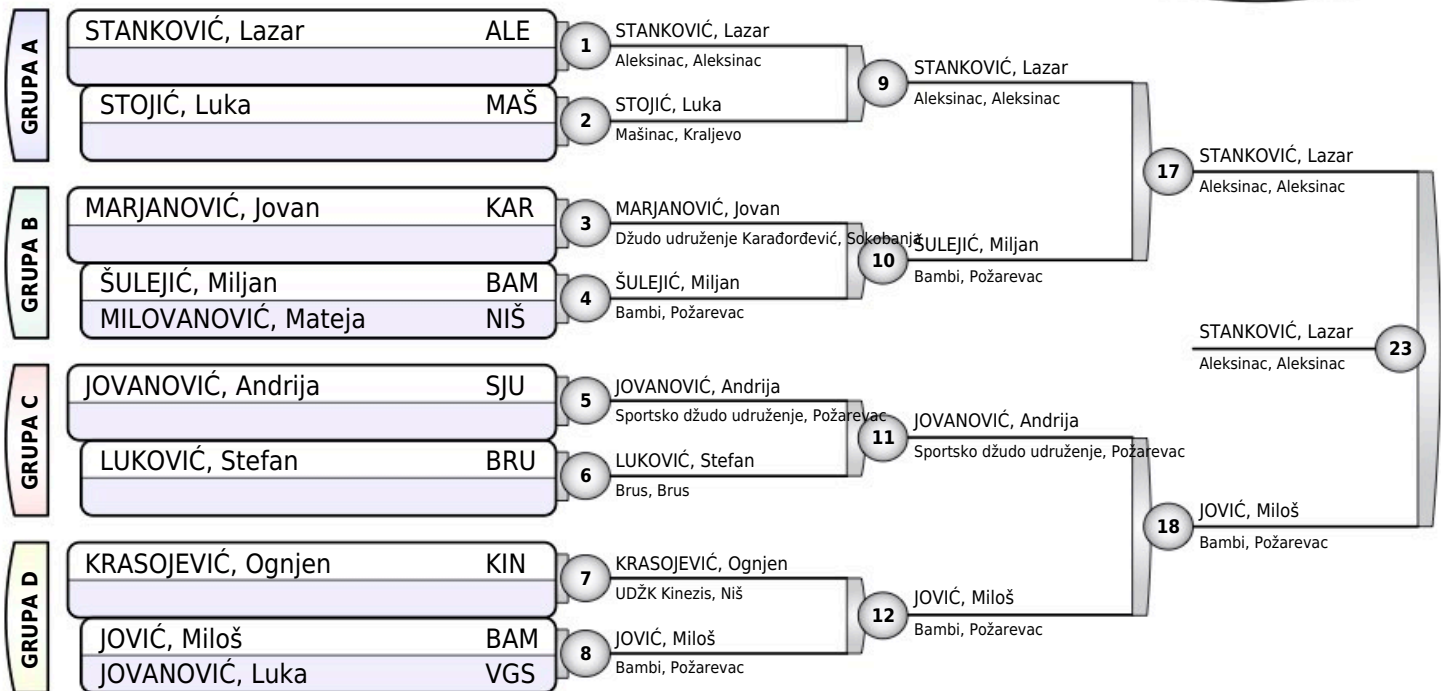

Rezultati

1. STANKOVIĆ, Lazar ALE
2. JOVIĆ, Miloš BAM
3. JOVANOVIĆ, Andrija SJU
3. ŠULEJIĆ, Miljan BAM
5. MILOVANOVIĆ, Mateja NIŠ
5. KRASOJEVIĆ, Ognjen KIN
7. STOJIĆ, Luka MAŠ
7. LUKOVIĆ, Stefan BRU

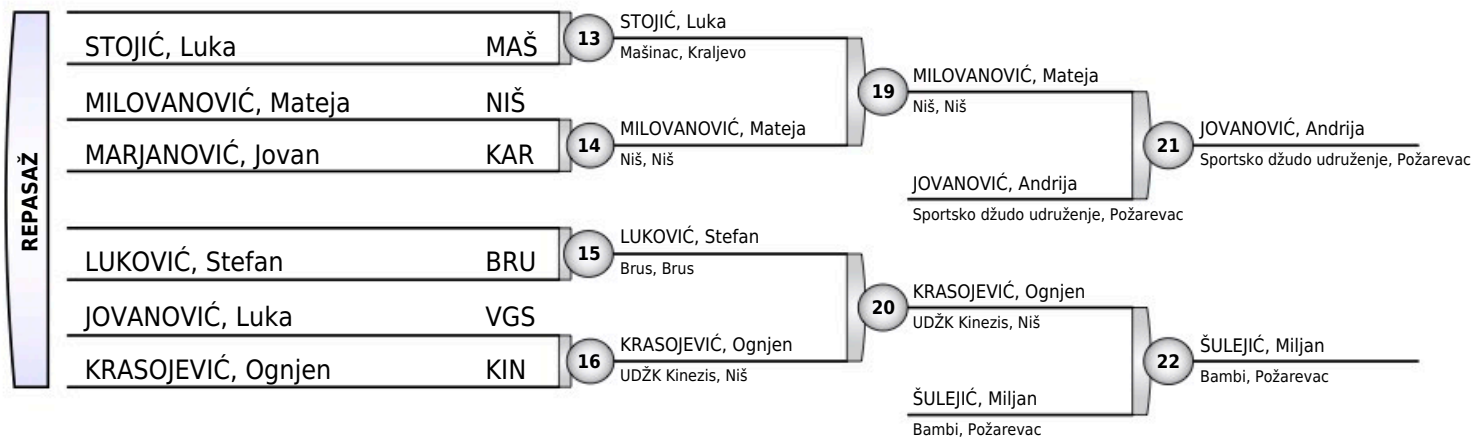



REGIONALNO CS KADETI

Niš, 05.02.2022.

KADETI
-73KG
12 takmičara

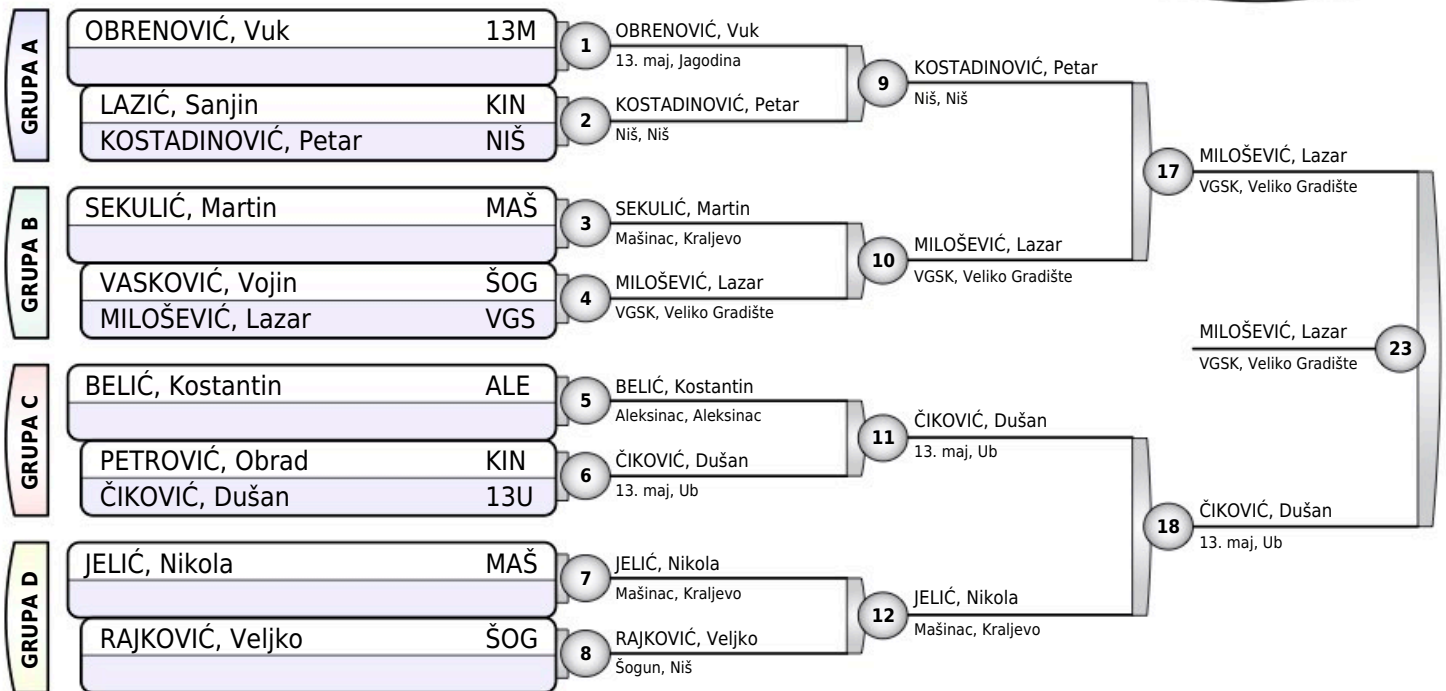

Rezultati

1. MILOŠEVIĆ, Lazar VGS
2. ČIKOVIĆ, Dušan 13U
3. SEKULIĆ, Martin MAŠ
3. KOSTADINOVIĆ, Petar NIŠ
5. JELIĆ, Nikola MAŠ
5. PETROVIĆ, Obrad KIN
7. LAZIĆ, Sanjin KIN
7. RAJKOVIĆ, Veljko ŠOG

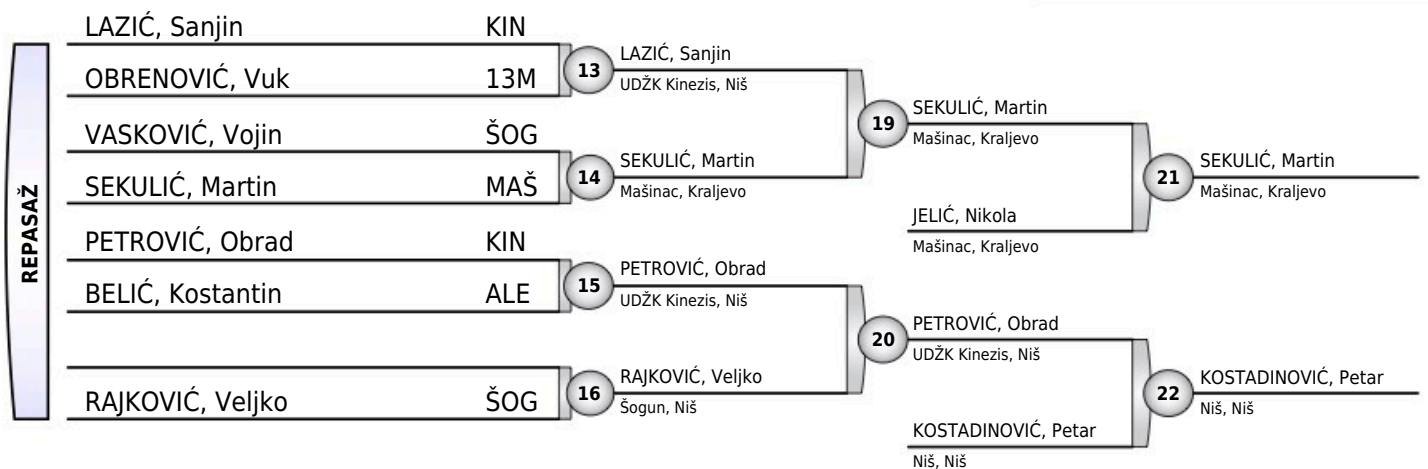



REGIONALNO CS KADETI

Niš, 05.02.2022.

KADETI
-81KG
7 takmičara

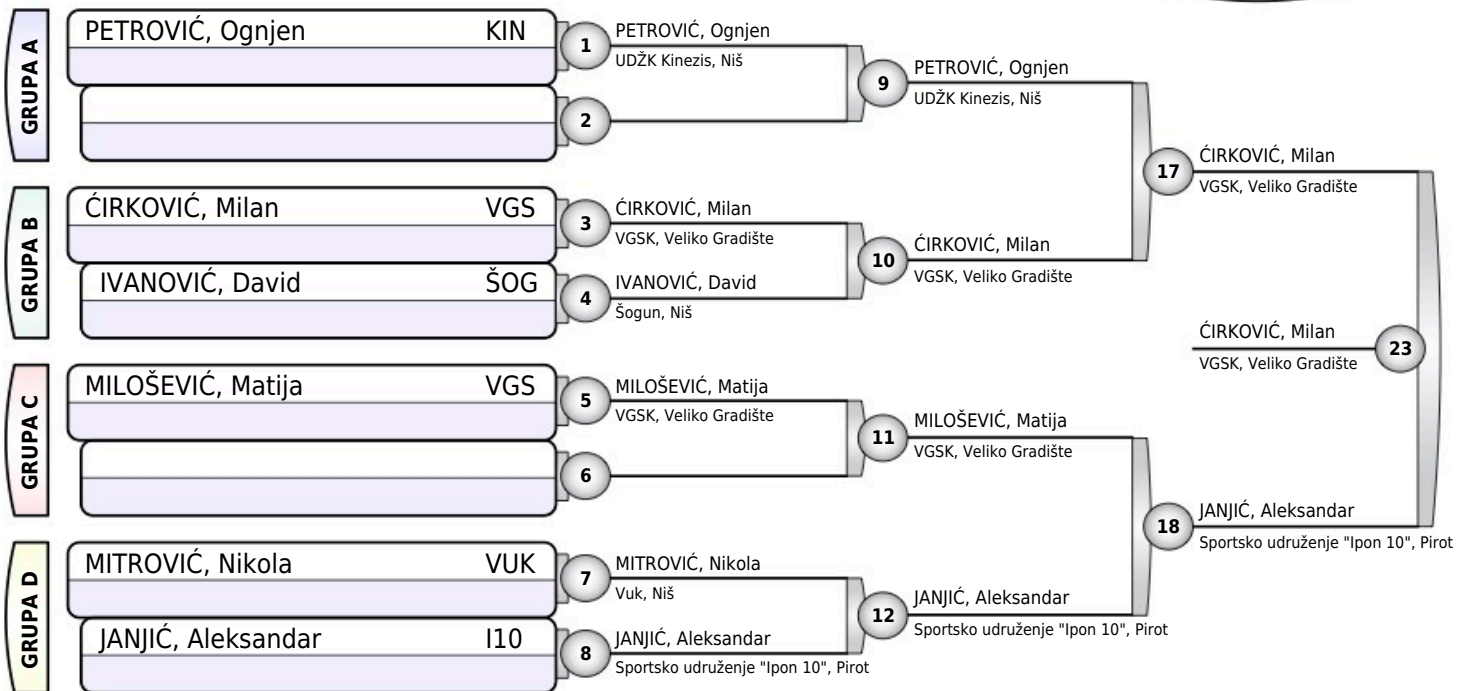

Rezultati

1. ĆIRKOVIĆ, Milan VGS
2. JANJIĆ, Aleksandar I10
3. IVANOVIĆ, David ŠOG
3. PETROVIĆ, Ognjen KIN
5. MILOŠEVIĆ, Matija VGS
5. MITROVIĆ, Nikola VUK
- 7.
- 7.

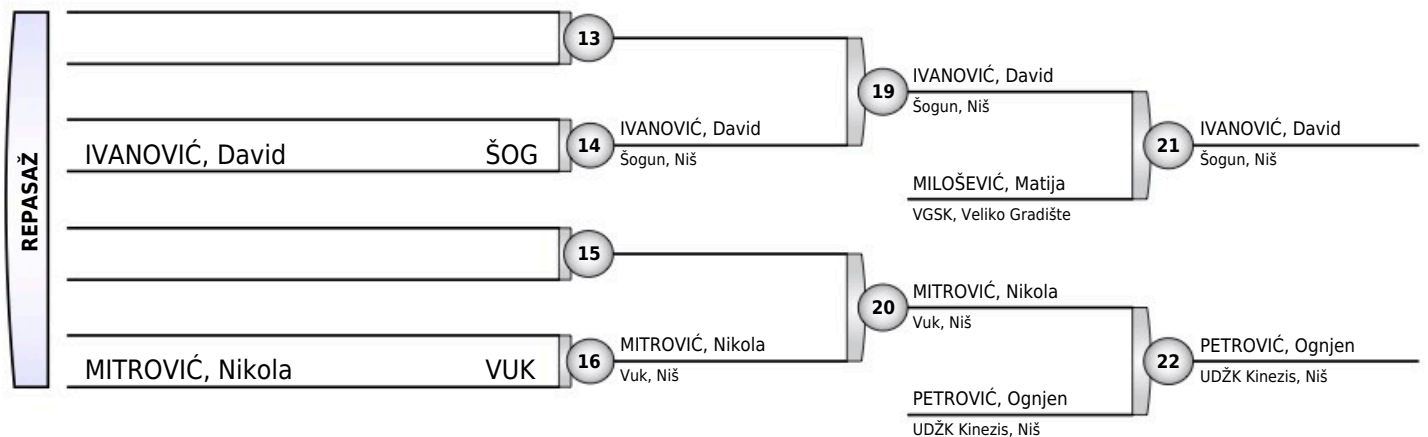



REGIONALNO CS KADETI

Niš, 05.02.2022.

KADETI
-90KG
5 takmičara

TAKMIČAR I KLUB	1	2	3	4	5	POBEDA	BODOVA	MESTO
1 DIMITRIJEVIĆ, Luka Leskovac, Leskovac		0	0	10	10	2	20	3
2 MIHAJLOVIĆ, Ilija 13. maj, Jagodina	10		0	10	10	3	30	2
3 ŠUNDOVIĆ, Veljko Mašinac, Kraljevo	10	10		10	10	4	40	1
4 KOJIĆ, Đorđe Brus, Brus	0	0	0		10	1	10	3
5 ĐORĐEVIĆ, Sreten Džudo udruženje Karadorđević, Sokobanja	0	0	0	0		0	0	5

DIMITRIJEVIĆ, Luka	LES	1	MIHAJLOVIĆ, Ilija
MIHAJLOVIĆ, Ilija	13M		13. maj, Jagodina
ŠUNDOVIĆ, Veljko	MAŠ	2	ŠUNDOVIĆ, Veljko
KOJIĆ, Đorđe	BRU		Mašinac, Kraljevo
DIMITRIJEVIĆ, Luka	LES	3	DIMITRIJEVIĆ, Luka
ĐORĐEVIĆ, Sreten	KAR		Leskovac, Leskovac
MIHAJLOVIĆ, Ilija	13M	4	ŠUNDOVIĆ, Veljko
ŠUNDOVIĆ, Veljko	MAŠ		Mašinac, Kraljevo
KOJIĆ, Đorđe	BRU	5	KOJIĆ, Đorđe
ĐORĐEVIĆ, Sreten	KAR		Brus, Brus
DIMITRIJEVIĆ, Luka	LES	6	ŠUNDOVIĆ, Veljko
ŠUNDOVIĆ, Veljko	MAŠ		Mašinac, Kraljevo
MIHAJLOVIĆ, Ilija	13M	7	MIHAJLOVIĆ, Ilija
KOJIĆ, Đorđe	BRU		13. maj, Jagodina
ŠUNDOVIĆ, Veljko	MAŠ	8	ŠUNDOVIĆ, Veljko
ĐORĐEVIĆ, Sreten	KAR		Mašinac, Kraljevo
DIMITRIJEVIĆ, Luka	LES	9	DIMITRIJEVIĆ, Luka
KOJIĆ, Đorđe	BRU		Leskovac, Leskovac
MIHAJLOVIĆ, Ilija	13M	10	MIHAJLOVIĆ, Ilija
ĐORĐEVIĆ, Sreten	KAR		13. maj, Jagodina

Rezultati

1. ŠUNDOVIĆ, Veljko	MAŠ
2. MIHAJLOVIĆ, Ilija	13M
3. DIMITRIJEVIĆ, Luka	LES
3. KOJIĆ, Đorđe	BRU
5. ĐORĐEVIĆ, Sreten	KAR



REGIONALNO CS KADETI

Niš, 05.02.2022.

KADETI
+90KG
4 takmičara

TAKMIČAR I KLUB	1	2	3	4	POBEDA	BODOVA	MESTO
1 BEŠIRI, Aleks Sportsko udruženje "Ipon 10", Pirot	///	10	10	0	2	20	2
2 KOVAČEVIĆ, Luka Šogun, Niš	0	///	10	0	1	10	3
3 IVANOVIĆ, Đorđe UDŽK Kinezis, Niš	0	0	///	0	0	0	3
4 LAZIĆ, Uroš Niš, Niš	10	10	10	///	3	30	1

BEŠIRI, Aleks	I10	1	BEŠIRI, Aleks
KOVAČEVIĆ, Luka	ŠOG		Sportsko udruženje "Ipon 10", Pirot
IVANOVIĆ, Đorđe	KIN	2	LAZIĆ, Uroš
LAZIĆ, Uroš	NIŠ		Niš, Niš
BEŠIRI, Aleks	I10	3	BEŠIRI, Aleks
IVANOVIĆ, Đorđe	KIN		Sportsko udruženje "Ipon 10", Pirot
KOVAČEVIĆ, Luka	ŠOG	4	LAZIĆ, Uroš
LAZIĆ, Uroš	NIŠ		Niš, Niš
BEŠIRI, Aleks	I10	5	LAZIĆ, Uroš
LAZIĆ, Uroš	NIŠ		Niš, Niš
KOVAČEVIĆ, Luka	ŠOG	6	KOVAČEVIĆ, Luka
IVANOVIĆ, Đorđe	KIN		Šogun, Niš

Rezultati

1. LAZIĆ, Uroš NIŠ
2. BEŠIRI, Aleks I10
3. KOVAČEVIĆ, Luka ŠOG
3. IVANOVIĆ, Đorđe KIN



REGIONALNO CS KADETI

Niš, 05.02.2022.

KADETKINJE

-44KG

2 takmičarke

RAJKOVIĆ, Anja	13M	1	RAJKOVIĆ, Anja 13. maj, Jagodina
ARITONOVIĆ, Nikolina	BOR		
RAJKOVIĆ, Anja	13M	2	RAJKOVIĆ, Anja 13. maj, Jagodina
ARITONOVIĆ, Nikolina	BOR		
		3	

Rezultati

1. RAJKOVIĆ, Anja 13M
2. ARITONOVIĆ, Nikolina BOR



REGIONALNO CS KADETI

Niš, 05.02.2022.

KADETKINJE

-48KG

2 takmičarke

KOS, Ines	AKT	1	NIĆIFORVIĆ, Andjelija
NIĆIFORVIĆ, Andjelija	13M		13. maj, Jagodina
KOS, Ines	AKT	2	NIĆIFORVIĆ, Andjelija
NIĆIFORVIĆ, Andjelija	13M		13. maj, Jagodina
		3	

Rezultati

1. NIĆIFORVIĆ, Andjelija 13M
2. KOS, Ines AKT



REGIONALNO CS KADETI

Niš, 05.02.2022.

KADETKINJE

-52KG

7 takmičarki

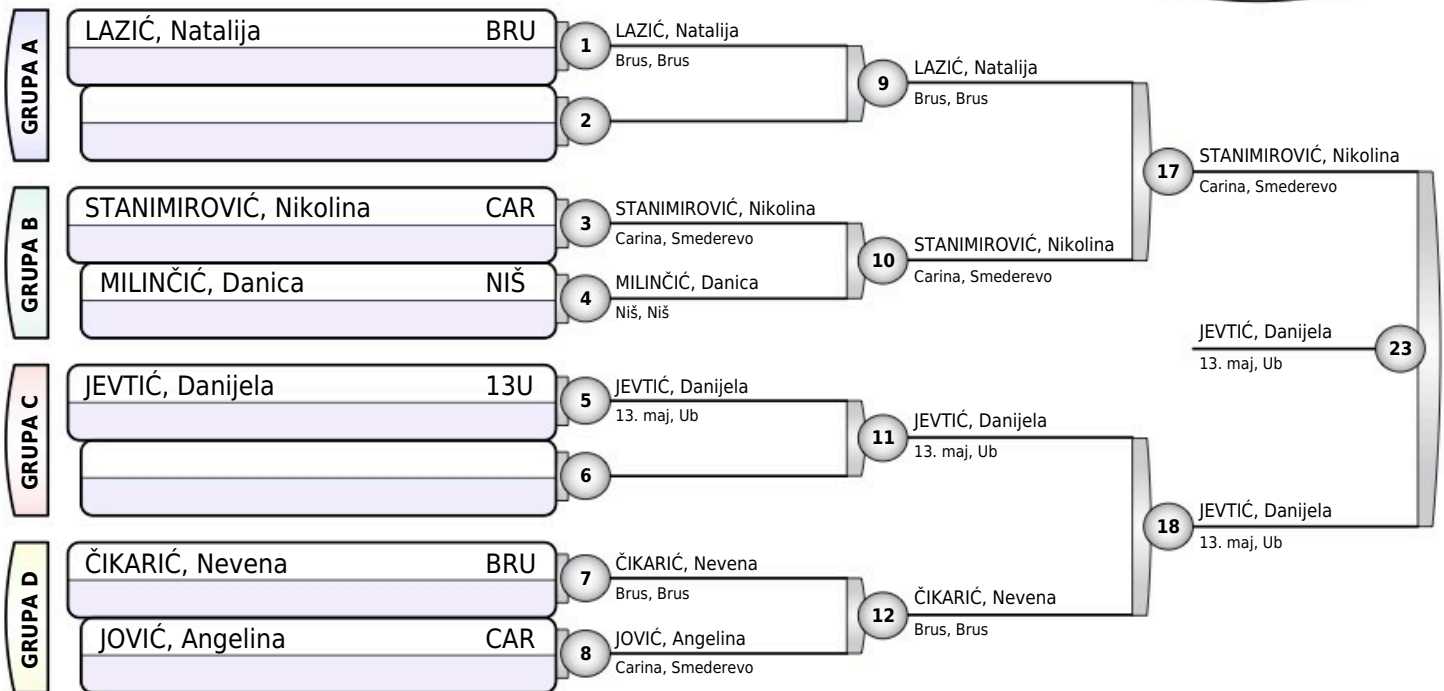

Rezultati

1. JEVTIĆ, Danijela 13U
2. STANIMIROVIĆ, Nikolina CAR
3. ČIKARIĆ, Nevena BRU
3. JOVIĆ, Angelina CAR
5. MILINČIĆ, Danica NIŠ
5. LAZIĆ, Natalija BRU
- 7.
- 7.

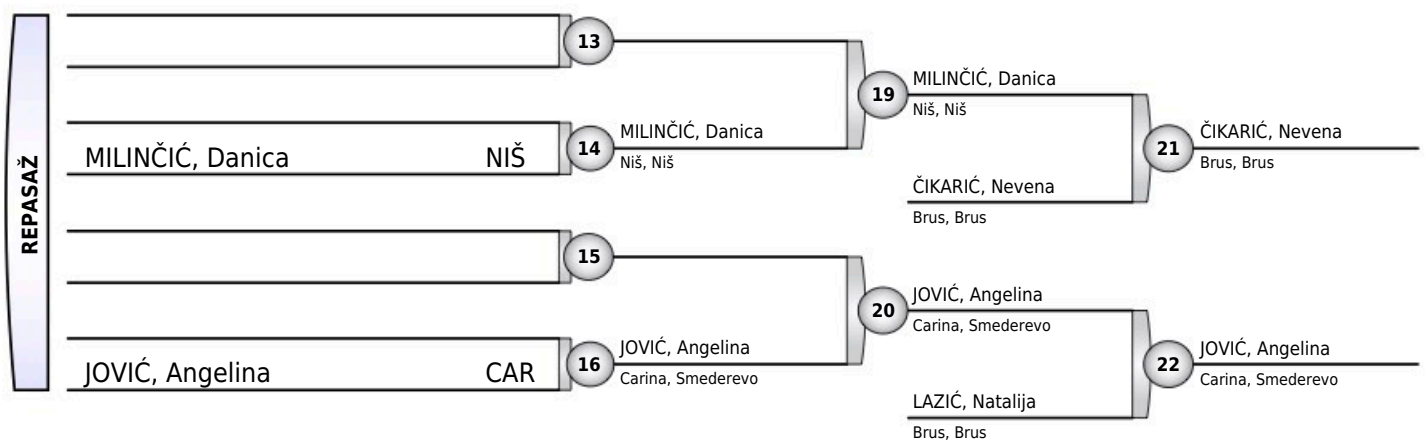



REGIONALNO CS KADETI

Niš, 05.02.2022.

KADETKINJE

-57KG

5 takmičarki

TAKMIČAR I KLUB	1	2	3	4	5	POBEDA	BODOVA	MESTO
1 KOCIĆ, Ksenija Kučevo, Kučevo	0	0	10	1	10	3	21	3
2 JOVIČIĆ, Sofija Sportsko udruženje "Ipon 10", Pirot	10	0	10	0	10	3	30	2
3 MITROVIC, Sandra Partizan, Kraljevo	0	0	0	0	10	1	10	3
4 KOJIĆ, Milica Carina, Smederevo	0	10	10	0	10	3	30	1
5 MITROVIC, Tea Partizan, Kraljevo	0	0	0	0	0	0	0	5

KOCIĆ, Ksenija	KUČ	1	JOVIČIĆ, Sofija
JOVIČIĆ, Sofija	I10		Sportsko udruženje "Ipon 10", Pirot
MITROVIC, Sandra	PKR	2	KOJIĆ, Milica
KOJIĆ, Milica	CAR		Carina, Smederevo
KOCIĆ, Ksenija	KUČ	3	KOCIĆ, Ksenija
MITROVIC, Tea	PKR		Kučevo, Kučevo
JOVIČIĆ, Sofija	I10	4	JOVIČIĆ, Sofija
MITROVIC, Sandra	PKR		Sportsko udruženje "Ipon 10", Pirot
KOJIĆ, Milica	CAR	5	KOJIĆ, Milica
MITROVIC, Tea	PKR		Carina, Smederevo
KOCIĆ, Ksenija	KUČ	6	KOCIĆ, Ksenija
MITROVIC, Sandra	PKR		Kučevo, Kučevo
JOVIČIĆ, Sofija	I10	7	KOJIĆ, Milica
KOJIĆ, Milica	CAR		Carina, Smederevo
MITROVIC, Sandra	PKR	8	MITROVIC, Sandra
MITROVIC, Tea	PKR		Partizan, Kraljevo
KOCIĆ, Ksenija	KUČ	9	KOCIĆ, Ksenija
KOJIĆ, Milica	CAR		Kučevo, Kučevo
JOVIČIĆ, Sofija	I10	10	JOVIČIĆ, Sofija
MITROVIC, Tea	PKR		Sportsko udruženje "Ipon 10", Pirot

Rezultati

1. KOJIĆ, Milica	CAR
2. JOVIČIĆ, Sofija	I10
3. KOCIĆ, Ksenija	KUČ
3. MITROVIC, Sandra	PKR
5. MITROVIC, Tea	PKR



REGIONALNO CS KADETI

Niš, 05.02.2022.

KADETKINJE

-63KG

4 takmičarki

TAKMIČAR I KLUB	1	2	3	4	POBEDA	BODOVA	MESTO
1 DANILOVIĆ, Aleksandra VGSK, Veliko Gradište		0	0	0	0	0	3
2 IVANOVIĆ, Anđela Šogun, Niš	10		0	10	2	20	2
3 JELIĆ, Milica 13. maj, Ub	10	10		10	3	30	1
4 ĐOKIĆ, Marija VGSK, Veliko Gradište	10	0	0		1	10	3

DANILOVIĆ, Aleksandra	VGS	1	IVANOVIĆ, Anđela
IVANOVIĆ, Anđela	ŠOG		Šogun, Niš
JELIĆ, Milica	13U	2	JELIĆ, Milica
ĐOKIĆ, Marija	VGS		13. maj, Ub
DANILOVIĆ, Aleksandra	VGS	3	JELIĆ, Milica
JELIĆ, Milica	13U		13. maj, Ub
IVANOVIĆ, Anđela	ŠOG	4	IVANOVIĆ, Anđela
ĐOKIĆ, Marija	VGS		Šogun, Niš
DANILOVIĆ, Aleksandra	VGS	5	ĐOKIĆ, Marija
ĐOKIĆ, Marija	VGS		VGSK, Veliko Gradište
IVANOVIĆ, Anđela	ŠOG	6	JELIĆ, Milica
JELIĆ, Milica	13U		13. maj, Ub

Rezultati

- JELIĆ, Milica 13U
- IVANOVIĆ, Anđela ŠOG
- ĐOKIĆ, Marija VGS
- DANILOVIĆ, Aleksandra VGS



REGIONALNO CS KADETI

Niš, 05.02.2022.

KADETKINJE
-70KG
5 takmičarki

TAKMIČAR I KLUB	1	2	3	4	5	POBEDA	BODOVA	MESTO
1 ŠULIĆ, Dejana UDŽK Kinezis, Niš		0	0	10	0	1	10	3
2 ŽIVKOVIĆ, Sofija 13. maj, Jagodina	10		1	10	10	4	31	1
3 JOVANOVIĆ, Milica Bor, Bor	10	0		10	10	3	30	2
4 STEFANOVIĆ, Andrijana Leskovac, Leskovac	0	0	0		0	0	0	5
5 CVETKOVIĆ, Ana Šogun, Niš	10	0	0	10		2	20	3

ŠULIĆ, Dejana	KIN	1	ŽIVKOVIĆ, Sofija
ŽIVKOVIĆ, Sofija	13M		13. maj, Jagodina
JOVANOVIĆ, Milica	BOR	2	JOVANOVIĆ, Milica
STEFANOVIĆ, Andrijana	LES		Bor, Bor
ŠULIĆ, Dejana	KIN	3	CVETKOVIĆ, Ana
CVETKOVIĆ, Ana	ŠOG		Šogun, Niš
ŽIVKOVIĆ, Sofija	13M	4	ŽIVKOVIĆ, Sofija
JOVANOVIĆ, Milica	BOR		13. maj, Jagodina
STEFANOVIĆ, Andrijana	LES	5	CVETKOVIĆ, Ana
CVETKOVIĆ, Ana	ŠOG		Šogun, Niš
ŠULIĆ, Dejana	KIN	6	JOVANOVIĆ, Milica
JOVANOVIĆ, Milica	BOR		Bor, Bor
ŽIVKOVIĆ, Sofija	13M	7	ŽIVKOVIĆ, Sofija
STEFANOVIĆ, Andrijana	LES		13. maj, Jagodina
JOVANOVIĆ, Milica	BOR	8	JOVANOVIĆ, Milica
CVETKOVIĆ, Ana	ŠOG		Bor, Bor
ŠULIĆ, Dejana	KIN	9	ŠULIĆ, Dejana
STEFANOVIĆ, Andrijana	LES		UDŽK Kinezis, Niš
ŽIVKOVIĆ, Sofija	13M	10	ŽIVKOVIĆ, Sofija
CVETKOVIĆ, Ana	ŠOG		13. maj, Jagodina

Rezultati

1. ŽIVKOVIĆ, Sofija 13M
2. JOVANOVIĆ, Milica BOR
3. CVETKOVIĆ, Ana ŠOG
3. ŠULIĆ, Dejana KIN
5. STEFANOVIĆ, Andrijana LES



REGIONALNO CS KADETI

Niš, 05.02.2022.

KADETKINJE
+70KG
4 takmičarki

TAKMIČAR I KLUB	1	2	3	4	POBEDA	BODOVA	MESTO
1 ŠAINOVIC, Sara Bor, Bor		10	10	0	2	20	2
2 PETKOVIĆ, Andrijana Župa Aleksandrovac, Aleksandrovac	0		10	0	1	10	3
3 STOJKOVIĆ, Anastasija Kučevo, Kučevo	0	0		0	0	0	3
4 ĐORĐEVIĆ, Teodora Goč, Vrnjačka Banja	10	10	10		3	30	1

ŠAINOVIC, Sara	BOR	1	ŠAINOVIC, Sara
PETKOVIĆ, Andrijana	ŽAL		Bor, Bor
STOJKOVIĆ, Anastasija	KUČ	2	ĐORĐEVIĆ, Teodora
ĐORĐEVIĆ, Teodora	GOČ		Goč, Vrnjačka Banja
ŠAINOVIC, Sara	BOR	3	ŠAINOVIC, Sara
STOJKOVIĆ, Anastasija	KUČ		Bor, Bor
PETKOVIĆ, Andrijana	ŽAL	4	ĐORĐEVIĆ, Teodora
ĐORĐEVIĆ, Teodora	GOČ		Goč, Vrnjačka Banja
ŠAINOVIC, Sara	BOR	5	ĐORĐEVIĆ, Teodora
ĐORĐEVIĆ, Teodora	GOČ		Goč, Vrnjačka Banja
PETKOVIĆ, Andrijana	ŽAL	6	PETKOVIĆ, Andrijana
STOJKOVIĆ, Anastasija	KUČ		Župa Aleksandrovac, Aleksandrovac

Rezultati

1. ĐORĐEVIĆ, Teodora GOČ
2. ŠAINOVIC, Sara BOR
3. PETKOVIĆ, Andrijana ŽAL
3. STOJKOVIĆ, Anastasija KUČ