



TROFEJ GRADA PANČEVA

Pančevo, 19.03.2022.

STARIJI POLETARCI

-25KG

14 takmičara

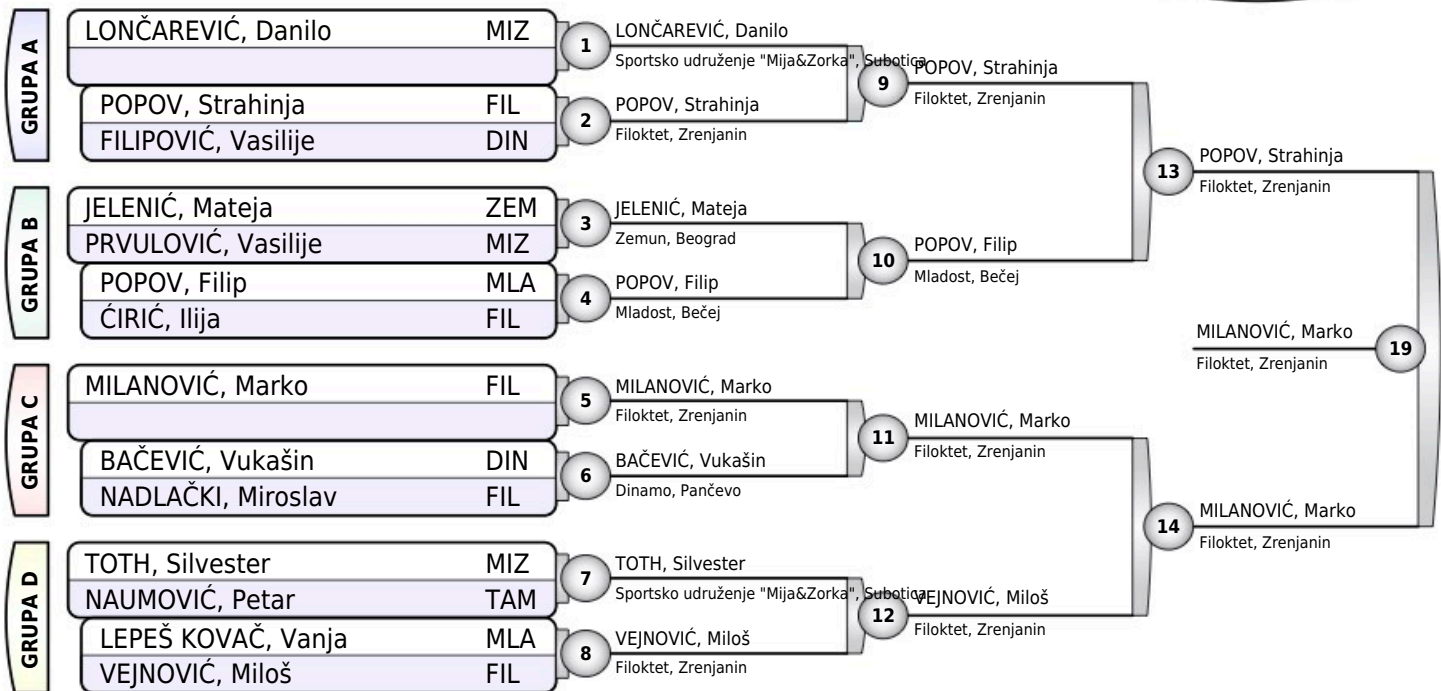

Rezultati

- MILANOVIĆ, Marko FIL
- POPOV, Strahinja FIL
- LONČAREVIĆ, Danilo MIZ
- VEJNOVIĆ, Miloš FIL
- POPOV, Filip MLA
- BAČEVIĆ, Vukašin DIN
- FILIPOVIĆ, Vasilije DIN
-

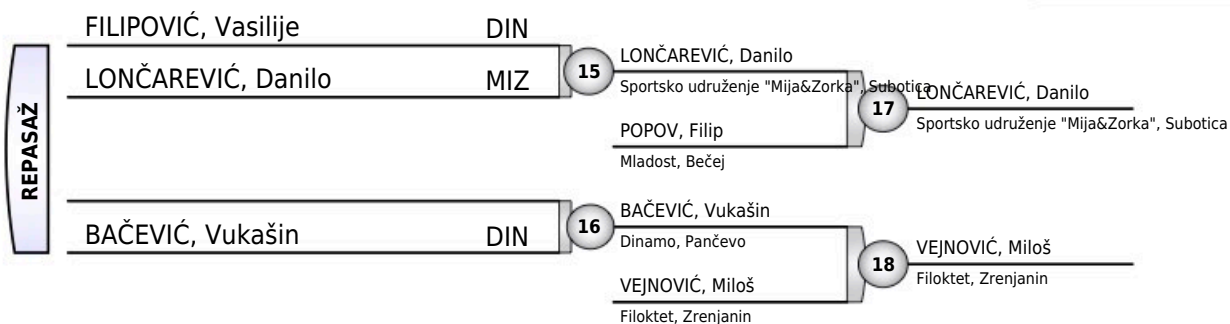



TROFEJ GRADA PANČEVA

Pančevo, 19.03.2022.

STARIJI POLETARCI

-28KG

12 takmičara

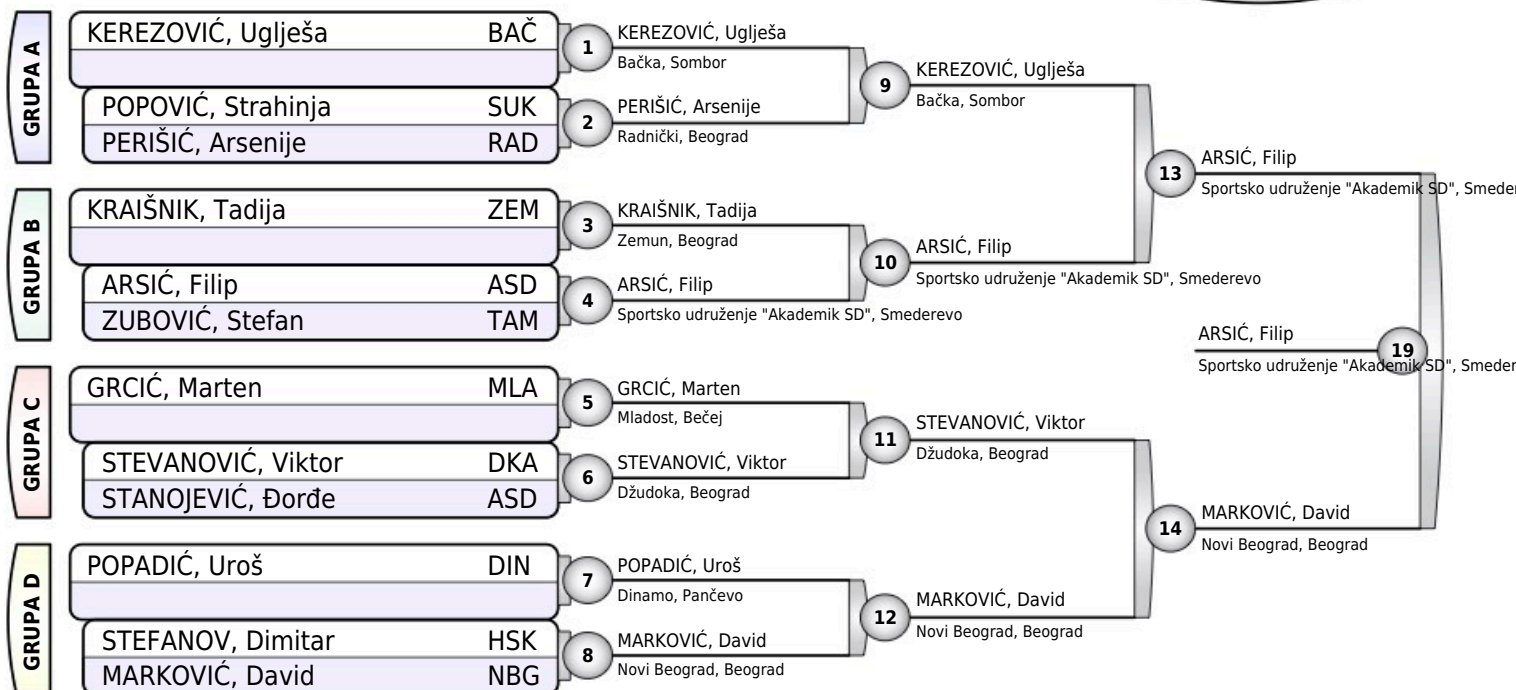

Rezultati

1. ARSIĆ, Filip ASD
2. MARKOVIĆ, David NBG
3. KEREZOVIĆ, Uglješa BAČ
3. STEVANOVIĆ, Viktor DKA
5. KRAIŠNIK, Tadija ZEM
5. STEFANOV, Dimitar HSK
7. ZUBOVIĆ, Stefan TAM
7. POPADIĆ, Uroš DIN

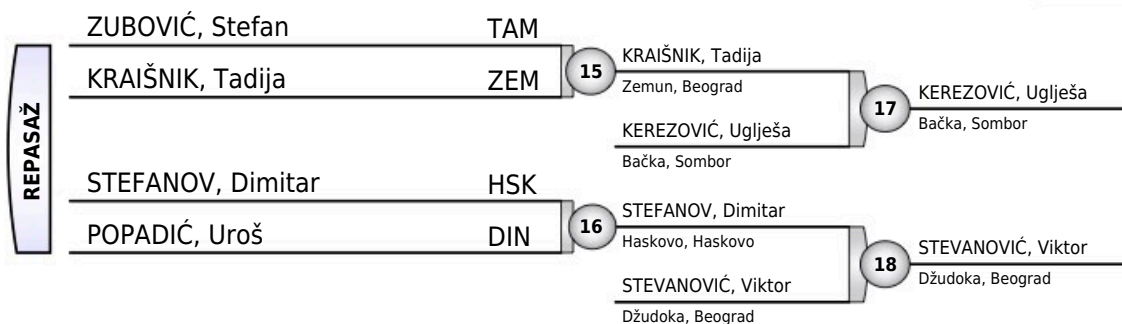



TROFEJ GRADA PANČEVA

Pančevo, 19.03.2022.

STARIJI POLETARCI

-31KG

19 takmičara

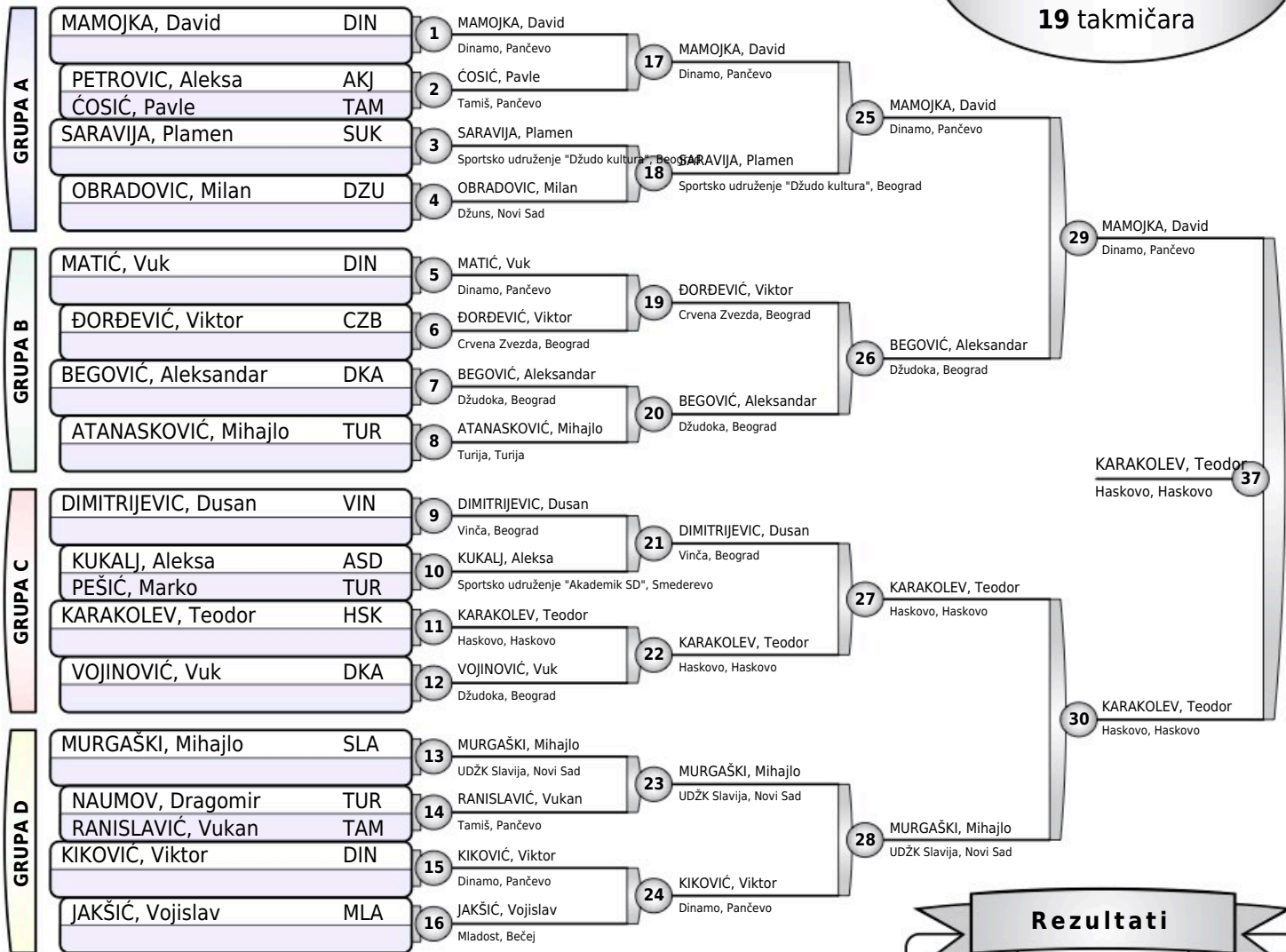

Rezultati

1. KARAKOLEV, Teodor HSK
2. MAMOJKA, David DIN
3. BEGOVIĆ, Aleksandar DKA
3. DIMITRIJEVIC, Dusan VIN
5. ĆOSIĆ, Pavle TAM
5. MURGAŠKI, Mihajlo SLA
7. SARAVIJA, Plamen SUK
7. VOJINOVIĆ, Vuk DKA



TROFEJ GRADA PANČEVA

Pančevo, 19.03.2022.

STARIJI POLETARCI

-34KG

24 takmičara

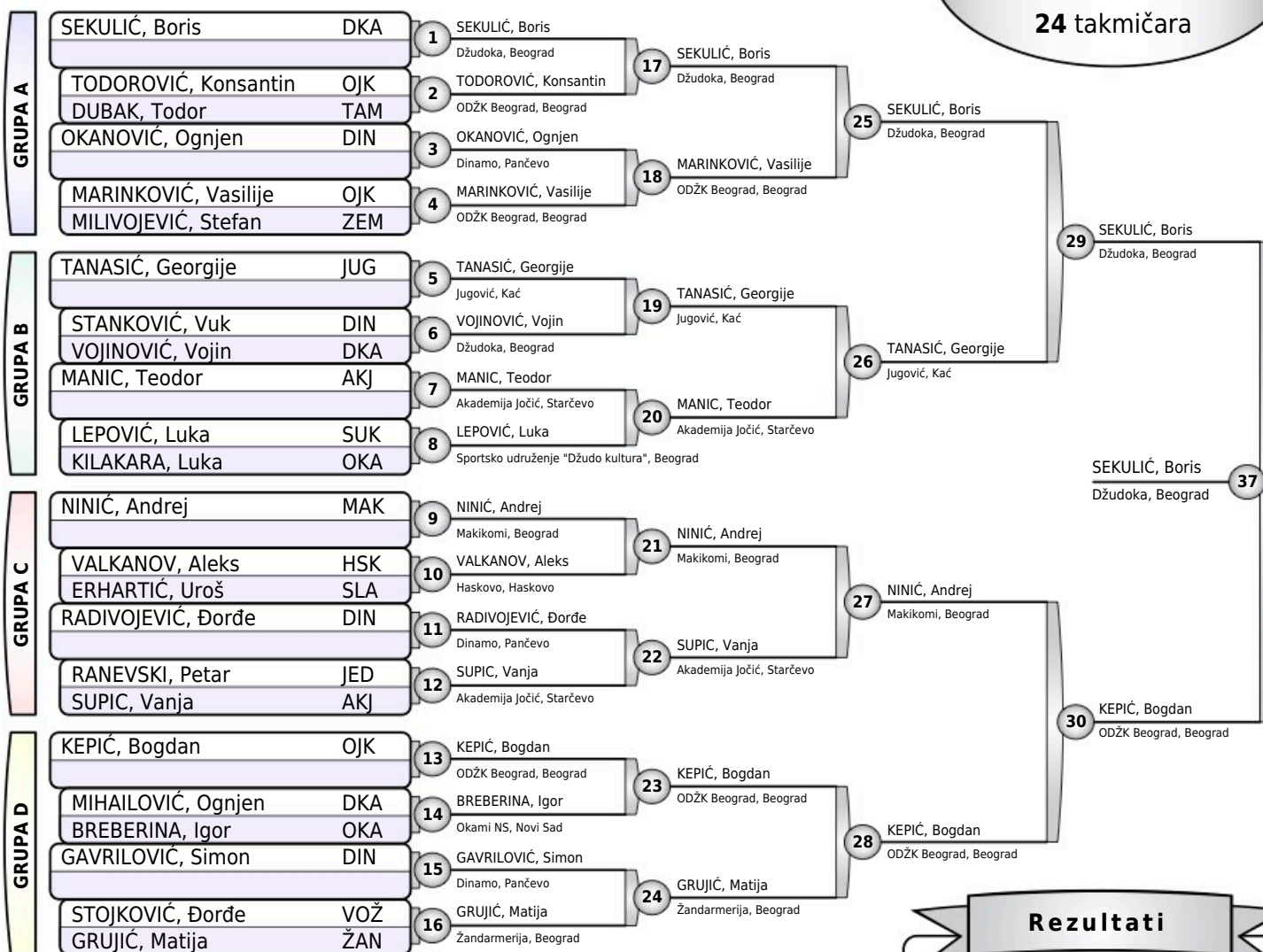

Rezultati

1. SEKULIĆ, Boris DKA
2. KEPIĆ, Bogdan OJK
3. TODOROVIĆ, Konsantin OJK
3. NINIĆ, Andrej MAK
5. TANASIĆ, Georgije JUG
5. BREBERINA, Igor OKA
7. MARINKOVIĆ, Vasilije OJK
7. GRUJIĆ, Matija ŽAN

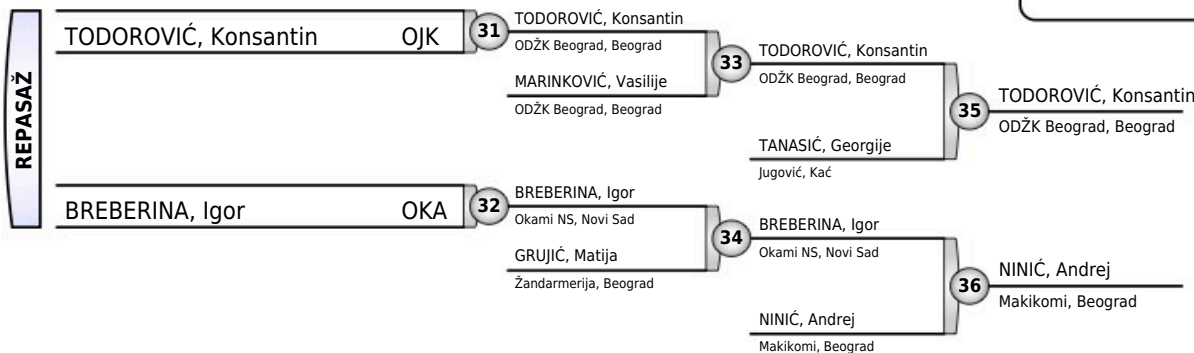



TROFEJ GRADA PANČEVA

Pančevo, 19.03.2022.

STARIJI POLETARCI

-38KG

16 takmičara

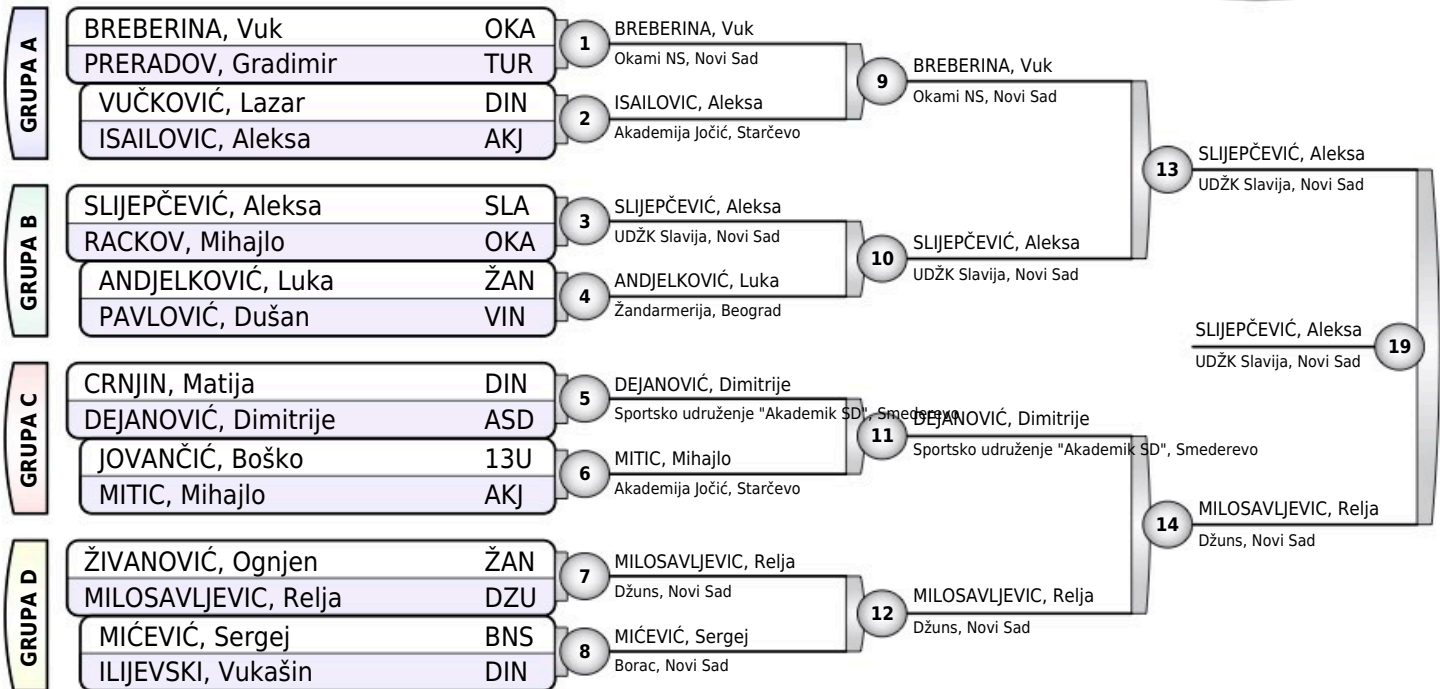

Rezultati

- SLIJEPČEVIĆ, Aleksa SLA
- MILOSAVLJEVIC, Relja DZU
- BREBERINA, Vuk OKA
- DEJANOVIĆ, Dimitrije ASD
- ANDJELKOVIĆ, Luka ŽAN
- ŽIVANOVIĆ, Ognjen ŽAN
- RACKOV, Mihajlo OKA
- MIĆEVIĆ, Sergej BNS





TROFEJ GRADA PANČEVA

Pančevo, 19.03.2022.

STARIJI POLETARCI

-42KG

16 takmičara

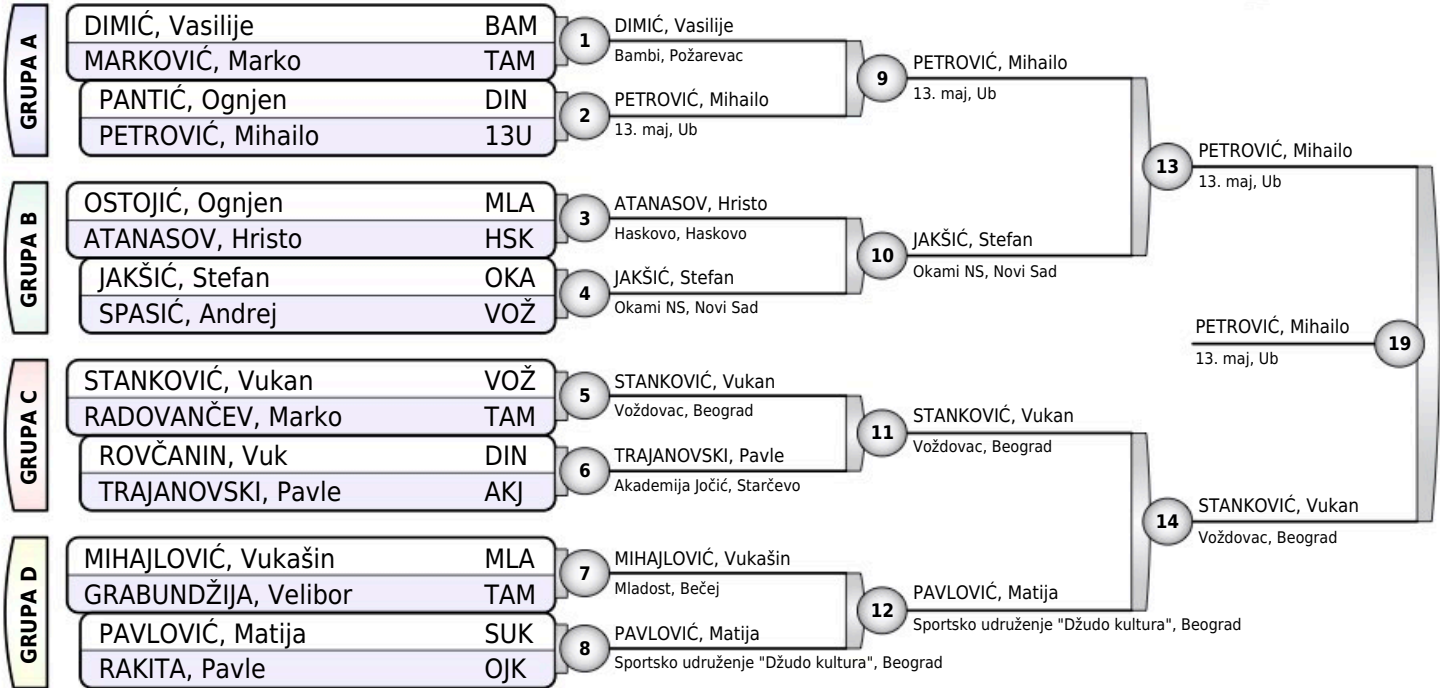

Rezultati

- PETROVIĆ, Mihailo 13U
- STANKOVIĆ, Vukan VOŽ
- JAKŠIĆ, Stefan OKA
- PAVLOVIĆ, Matija SUK
- DIMIĆ, Vasilije BAM
- TRAJANOVSKI, Pavle AKJ
- PANTIĆ, Ognjen DIN
- RADOVANČEV, Marko TAM

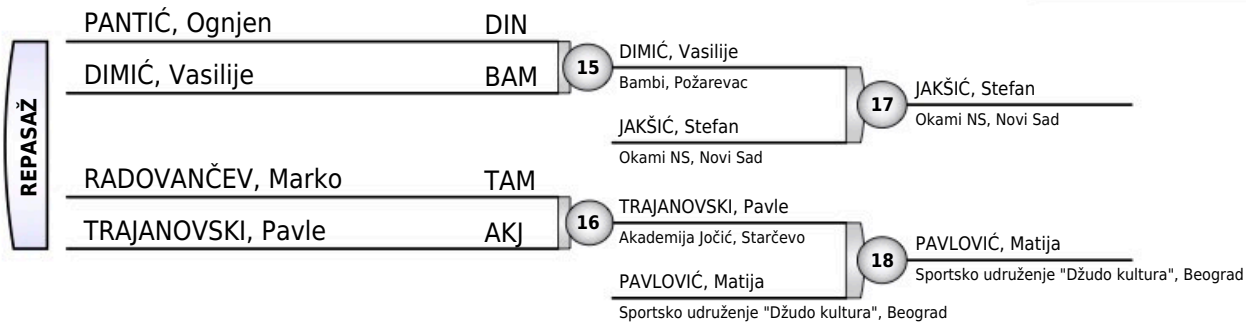



TROFEJ GRADA PANČEVA

Pančevo, 19.03.2022.

STARIJI POLETARCI

-46KG

14 takmičara

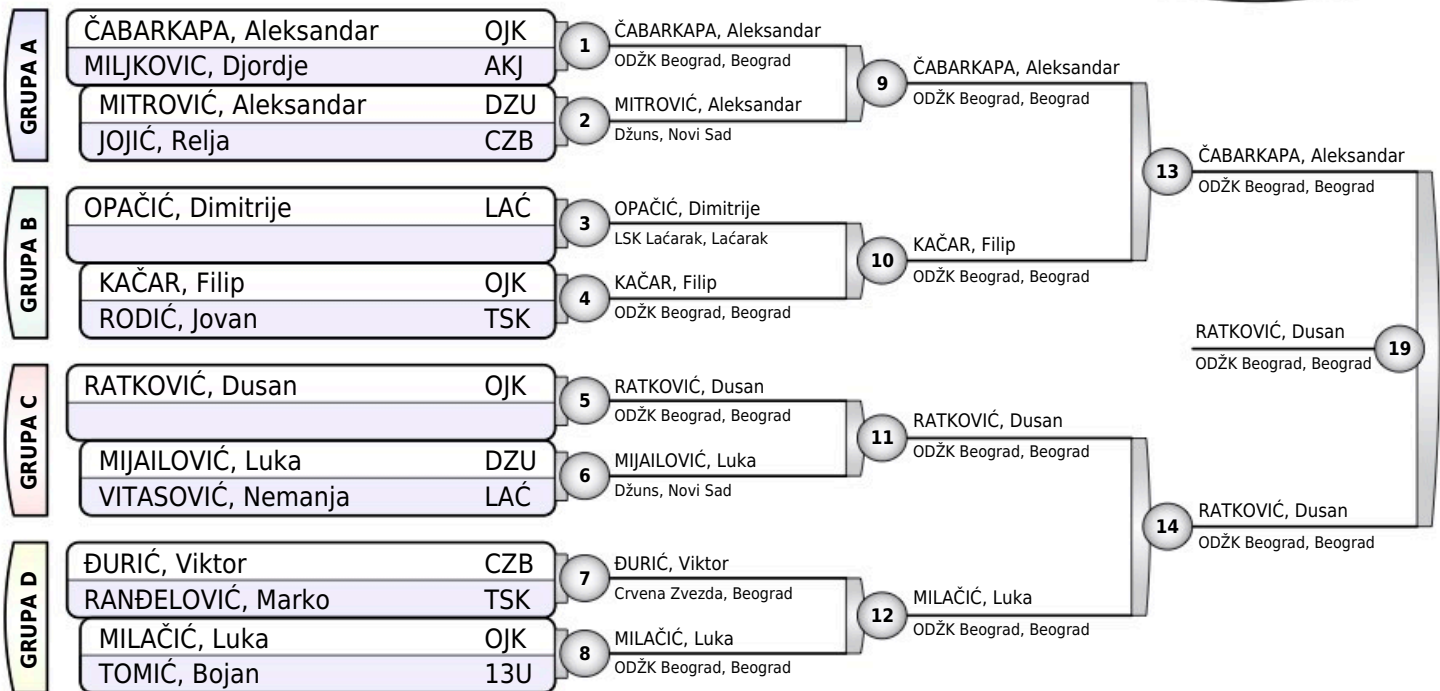

Rezultati

1. RATKOVIĆ, Dusan OJK
2. ČABARKAPA, Aleksandar OJK
3. KAČAR, Filip OJK
3. MIJAILOVIĆ, Luka DZU
5. MITROVIĆ, Aleksandar DZU
5. MILAČIĆ, Luka OJK
7. MILJKOVIC, Djordje AKJ
- 7.

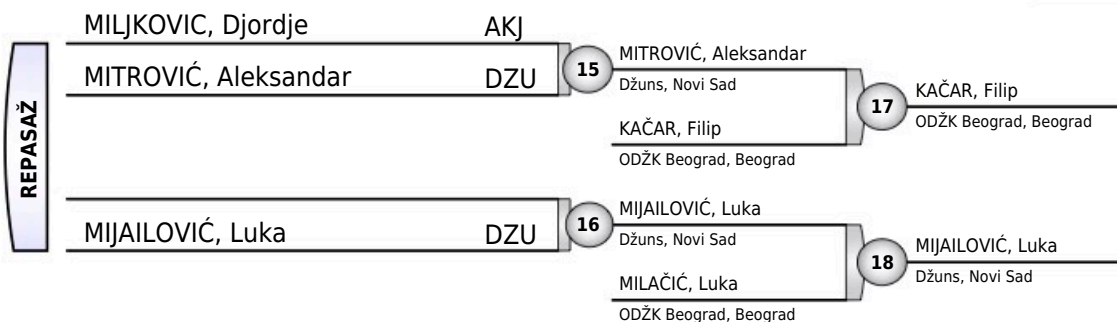



TROFEJ GRADA PANČEVA

Pančevo, 19.03.2022.

STARIJI POLETARCI

-50KG

3 takmičara

TAKMIČAR I KLUB	1	2	3	POBEDA	BODOVA	MESTO
1 NIKOLIĆ, Stefan Dinamo, Pančevo		0	0	0	0	3
2 SMILJKIĆ, Milan Sportsko udruženje "Bulbulder D.L.V.S", Beograd	10		10	2	20	1
3 PANTIĆ, Strahinja Dinamo, Pančevo	10	0		1	10	2

NIKOLIĆ, Stefan	DIN	1	SMILJKIĆ, Milan
SMILJKIĆ, Milan	BLB		Sportsko udruženje "Bulbulder D.L.V.S", Beograd
NIKOLIĆ, Stefan	DIN	2	PANTIĆ, Strahinja
PANTIĆ, Strahinja	DIN		Dinamo, Pančevo
SMILJKIĆ, Milan	BLB	3	SMILJKIĆ, Milan
PANTIĆ, Strahinja	DIN		Sportsko udruženje "Bulbulder D.L.V.S", Beograd

Rezultati

- | | |
|----------------------|-----|
| 1. SMILJKIĆ, Milan | BLB |
| 2. PANTIĆ, Strahinja | DIN |
| 3. NIKOLIĆ, Stefan | DIN |



TROFEJ GRADA PANČEVA

Pančevo, 19.03.2022.

STARIJI POLETARCI

+50KG

5 takmičara

TAKMIČAR I KLUB	1	2	3	4	5	POBEDA	BODOVA	MESTO
1 ĐORĐEVIĆ, Luka 13. maj, Ub		0	10	0	0	1	10	3
2 BOGIĆ, Djordje Bambi, Požarevac	10		10	10	1	4	31	1
3 RELJIĆ, Miloš Dinamo, Pančevo	0	0		0	0	0	0	5
4 KEKIĆ, Stefan Mladost, Bečej	10	0	10		0	2	20	3
5 TURKOVIĆ, Viktor Voždovac, Beograd	10	0	10	10		3	30	2

ĐORĐEVIĆ, Luka	13U	1	BOGIĆ, Djordje
BOGIĆ, Djordje	BAM		Bambi, Požarevac
RELJIĆ, Miloš	DIN	2	KEKIĆ, Stefan
KEKIĆ, Stefan	MLA		Mladost, Bečej
ĐORĐEVIĆ, Luka	13U	3	TURKOVIĆ, Viktor
TURKOVIĆ, Viktor	VOŽ		Voždovac, Beograd
BOGIĆ, Djordje	BAM	4	BOGIĆ, Djordje
RELJIĆ, Miloš	DIN		Bambi, Požarevac
KEKIĆ, Stefan	MLA	5	TURKOVIĆ, Viktor
TURKOVIĆ, Viktor	VOŽ		Voždovac, Beograd
ĐORĐEVIĆ, Luka	13U	6	ĐORĐEVIĆ, Luka
RELJIĆ, Miloš	DIN		13. maj, Ub
BOGIĆ, Djordje	BAM	7	BOGIĆ, Djordje
KEKIĆ, Stefan	MLA		Bambi, Požarevac
RELJIĆ, Miloš	DIN	8	TURKOVIĆ, Viktor
TURKOVIĆ, Viktor	VOŽ		Voždovac, Beograd
ĐORĐEVIĆ, Luka	13U	9	KEKIĆ, Stefan
KEKIĆ, Stefan	MLA		Mladost, Bečej
BOGIĆ, Djordje	BAM	10	BOGIĆ, Djordje
TURKOVIĆ, Viktor	VOŽ		Bambi, Požarevac

Rezultati

- | | |
|---------------------|-----|
| 1. BOGIĆ, Djordje | BAM |
| 2. TURKOVIĆ, Viktor | VOŽ |
| 3. KEKIĆ, Stefan | MLA |
| 3. ĐORĐEVIĆ, Luka | 13U |
| 5. RELJIĆ, Miloš | DIN |



TROFEJ GRADA PANČEVA

Pančevo, 19.03.2022.

STARIJE POLETARKE

-25KG

3 takmičarke

TAKMIČAR I KLUB	1	2	3	POBEDA	BODOVA	MESTO
1 SIRIŠKI, Tara Turija, Turija		10	0	1	10	2
2 STANČIĆ, Valentina Filoktet, Zrenjanin	0		0	0	0	3
3 RADOSAVLJEVIĆ, Maša Sportsko udruženje "Akademik SD", Smederevo	10	1		2	11	1

SIRIŠKI, Tara	TUR	1	SIRIŠKI, Tara
STANČIĆ, Valentina	FIL		Turija, Turija
SIRIŠKI, Tara	TUR	2	RADOSAVLJEVIĆ, Maša
RADOSAVLJEVIĆ, Maša	ASD		Sportsko udruženje "Akademik SD", Smederevo
STANČIĆ, Valentina	FIL	3	RADOSAVLJEVIĆ, Maša
RADOSAVLJEVIĆ, Maša	ASD		Sportsko udruženje "Akademik SD", Smederevo

Rezultati

1. RADOSAVLJEVIĆ, Maša ASD
2. SIRIŠKI, Tara TUR
3. STANČIĆ, Valentina FIL



TROFEJ GRADA PANČEVA

Pančevo, 19.03.2022.

STARIJE POLETARKE

-28KG

7 takmičarki

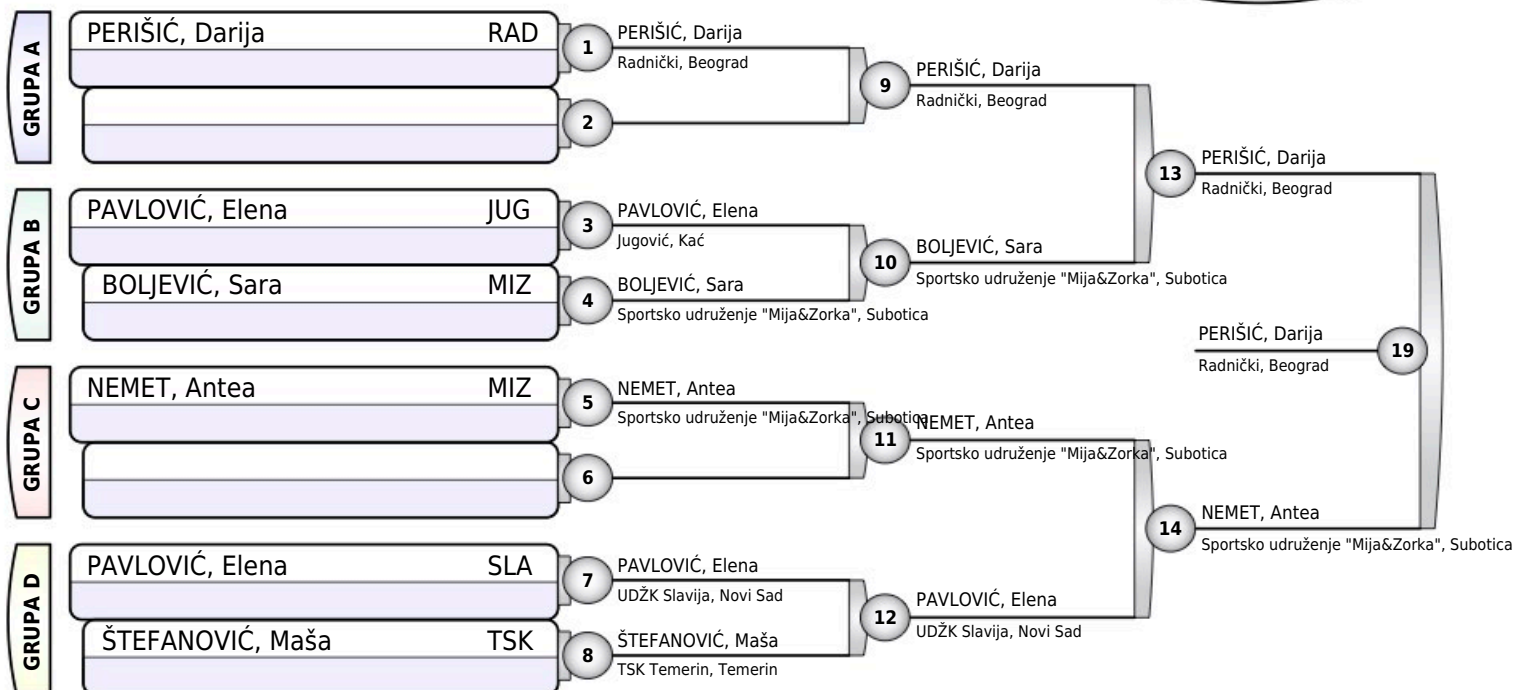

Rezultati

1. PERIŠIĆ, Darija RAD
2. NEMET, Antea MIZ
3. BOLJEVIĆ, Sara MIZ
3. PAVLOVIĆ, Elena SLA
- 5.
- 5.
- 7.
- 7.

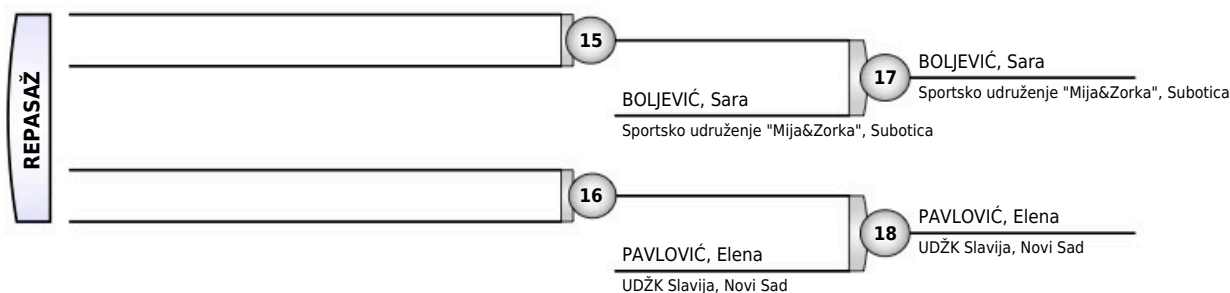



TROFEJ GRADA PANČEVA

Pančevo, 19.03.2022.

STARIJE POLETARKE

-31KG

7 takmičarki

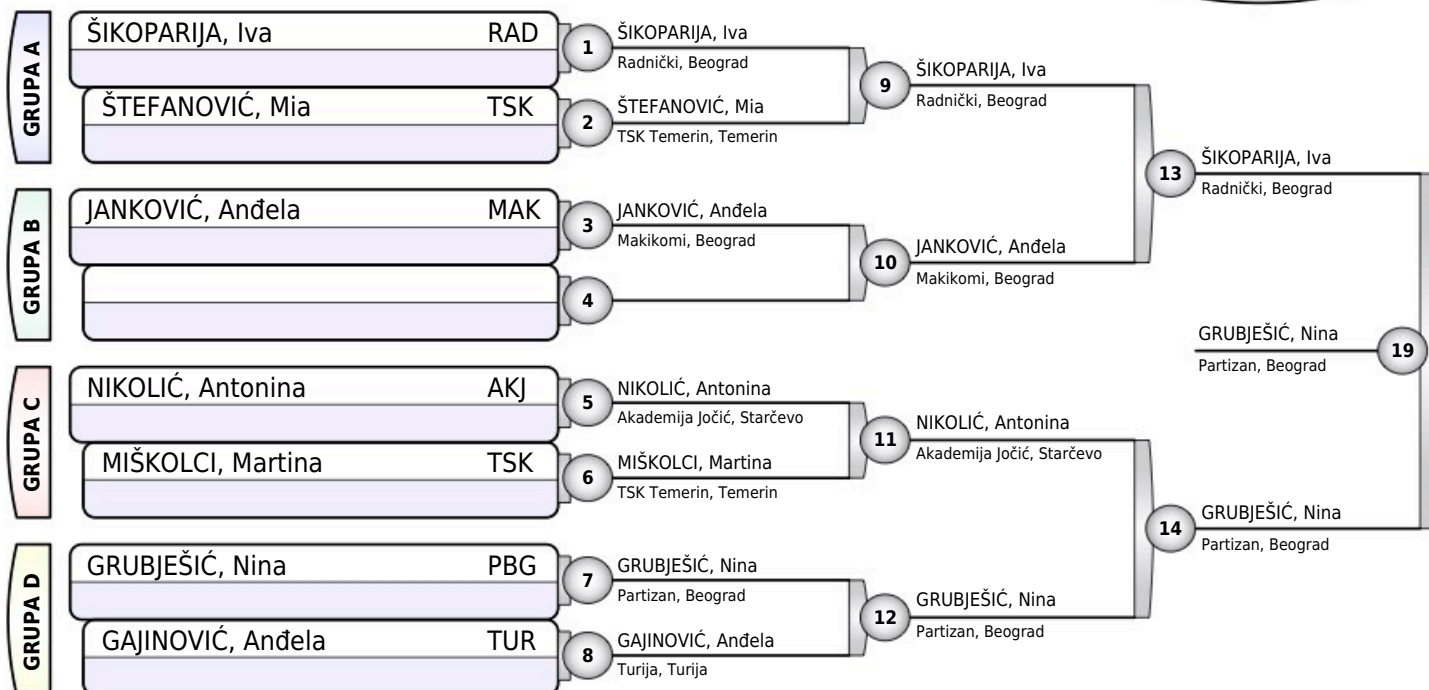

Rezultati

- GRUBJEŠIĆ, Nina (PBG)
- ŠIKOPARIJA, Iva (RAD)
- JANKOVIĆ, Anđela (MAK)
- NIKOLIĆ, Antonina (AKJ)
- ŠTEFANOVIĆ, Mia (TSK)
- GAJINOVIĆ, Anđela (TUR)
-
-

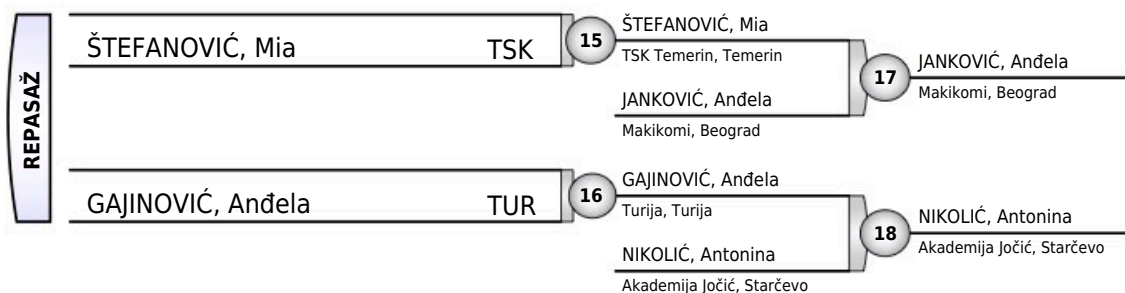



TROFEJ GRADA PANČEVA

Pančevo, 19.03.2022.

STARIJE POLETARKE

-34KG

7 takmičarki

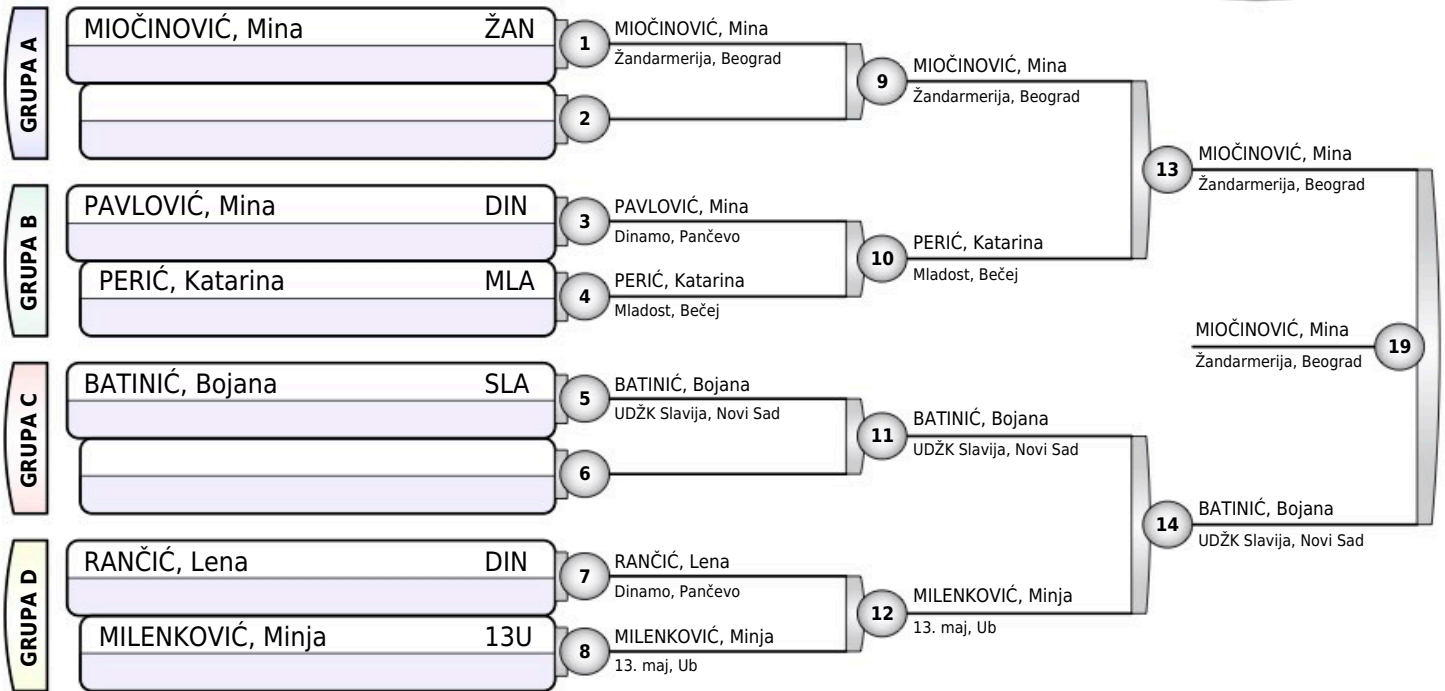

Rezultati

1. MIOČINOVIĆ, Mina ŽAN
2. BATINIĆ, Bojana SLA
3. PERIĆ, Katarina MLA
3. MILENKOVIĆ, Minja 13U
- 5.
- 5.
- 7.
- 7.

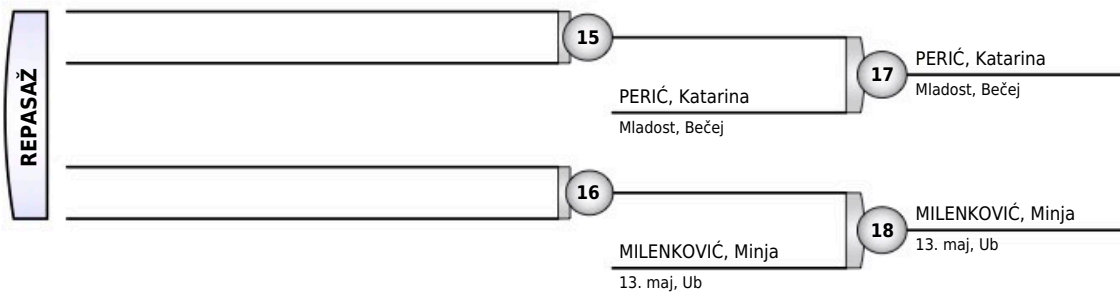



TROFEJ GRADA PANČEVA

Pančevo, 19.03.2022.

STARIJE POLETARKE

-38KG

5 takmičarki

TAKMIČAR I KLUB	1	2	3	4	5	POBEDA	BODOVA	MESTO
1 SVIRAC, Hana Knjaz Miloš, Beograd		0	0	10	0	1	10	3
2 JOVIĆ, Dunja Partizan, Beograd	10		10	10	10	4	40	1
3 SIMANIĆ, Staša Dinamo, Pančevo	10	0		10	0	2	20	3
4 SABO, Nevena Jugović, Kać	0	0	0		0	0	0	5
5 KIRALY, Kira Sportsko udruženje "Mija&Zorka", Subotica	10	0	10	10		3	30	2

SVIRAC, Hana	KNJ	1	JOVIĆ, Dunja
JOVIĆ, Dunja	PBG		Partizan, Beograd
SIMANIĆ, Staša	DIN	2	SIMANIĆ, Staša
SABO, Nevena	JUG		Dinamo, Pančevo
SVIRAC, Hana	KNJ	3	KIRALY, Kira
KIRALY, Kira	MIZ		Sportsko udruženje "Mija&Zorka", Subotica
JOVIĆ, Dunja	PBG	4	JOVIĆ, Dunja
SIMANIĆ, Staša	DIN		Partizan, Beograd
SABO, Nevena	JUG	5	KIRALY, Kira
KIRALY, Kira	MIZ		Sportsko udruženje "Mija&Zorka", Subotica
SVIRAC, Hana	KNJ	6	SIMANIĆ, Staša
SIMANIĆ, Staša	DIN		Dinamo, Pančevo
JOVIĆ, Dunja	PBG	7	JOVIĆ, Dunja
SABO, Nevena	JUG		Partizan, Beograd
SIMANIĆ, Staša	DIN	8	KIRALY, Kira
KIRALY, Kira	MIZ		Sportsko udruženje "Mija&Zorka", Subotica
SVIRAC, Hana	KNJ	9	SVIRAC, Hana
SABO, Nevena	JUG		Knjaz Miloš, Beograd
JOVIĆ, Dunja	PBG	10	JOVIĆ, Dunja
KIRALY, Kira	MIZ		Partizan, Beograd

Rezultati

- | | |
|-------------------|-----|
| 1. JOVIĆ, Dunja | PBG |
| 2. KIRALY, Kira | MIZ |
| 3. SIMANIĆ, Staša | DIN |
| 3. SVIRAC, Hana | KNJ |
| 5. SABO, Nevena | JUG |



TROFEJ GRADA PANČEVA

Pančevo, 19.03.2022.

STARIJE POLETARKE

-43KG

2 takmičarke

MILOSAVLJEVIĆ, Mia	TUR	1	JOVETIĆ, Lana
JOVETIĆ, Lana	TSK		TSK Temerin, Temerin
MILOSAVLJEVIĆ, Mia	TUR	2	JOVETIĆ, Lana
JOVETIĆ, Lana	TSK		TSK Temerin, Temerin
		3	

Rezultati

1. JOVETIĆ, Lana TSK
2. MILOSAVLJEVIĆ, Mia TUR



TROFEJ GRADA PANČEVA

Pančevo, 19.03.2022.

STARIJE POLETARKE

+43KG

2 takmičarke

MILOVANOVIĆ, Emilija	ŽAN	1	MILOVANOVIĆ, Emilija
RADUKIĆ, Anastasija	TUR		Žandarmerija, Beograd
MILOVANOVIĆ, Emilija	ŽAN	2	MILOVANOVIĆ, Emilija
RADUKIĆ, Anastasija	TUR		Žandarmerija, Beograd
		3	

Rezultati

1. MILOVANOVIĆ, Emilija ŽAN
2. RADUKIĆ, Anastasija TUR



TROFEJ GRADA PANČEVA

Pančevo, 19.03.2022.

MLAĐI DEČACI

-30KG

7 takmičara

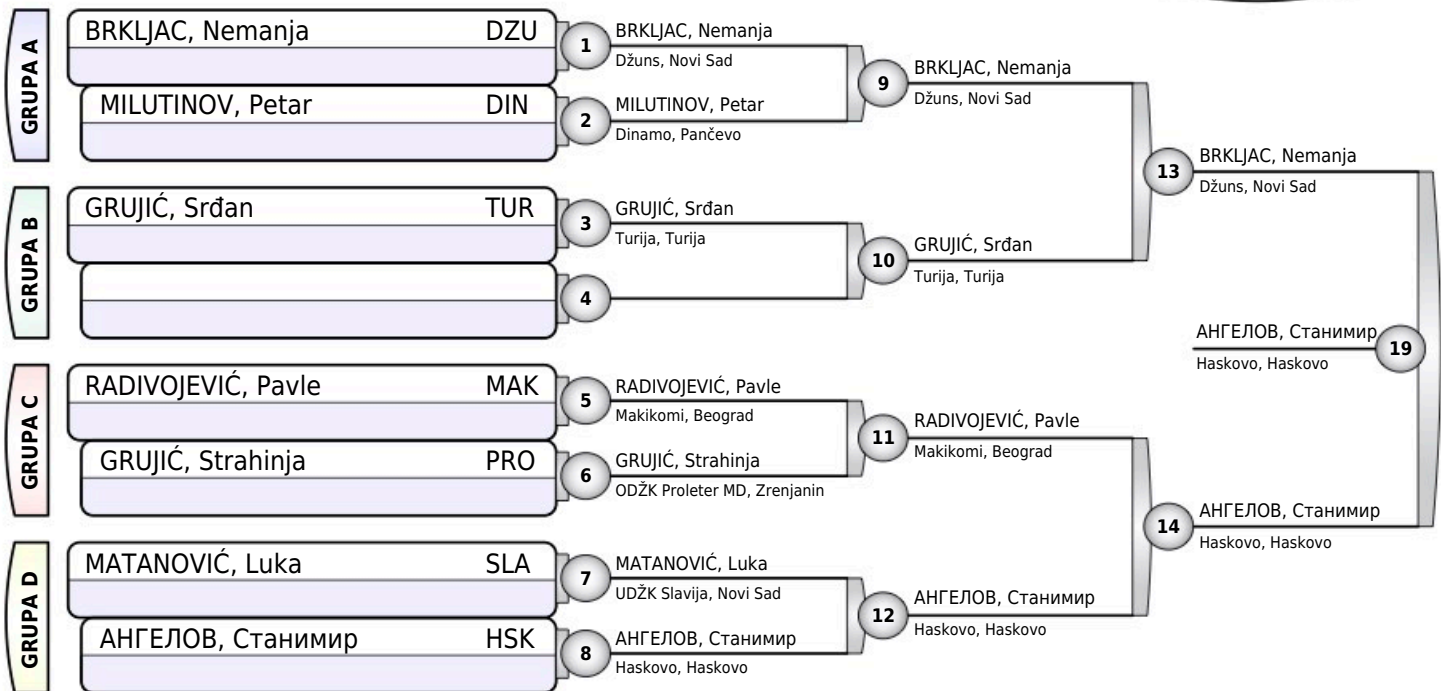

Rezultati

1. ANGELOV, Stanimir HSK
2. BRKLJAC, Nemanja DZU
3. MILUTINOV, Petar DIN
3. RADIVOJEVIĆ, Pavle MAK
5. GRUJIĆ, Srđan TUR
5. MATANOVIĆ, Luka SLA
- 7.
- 7.

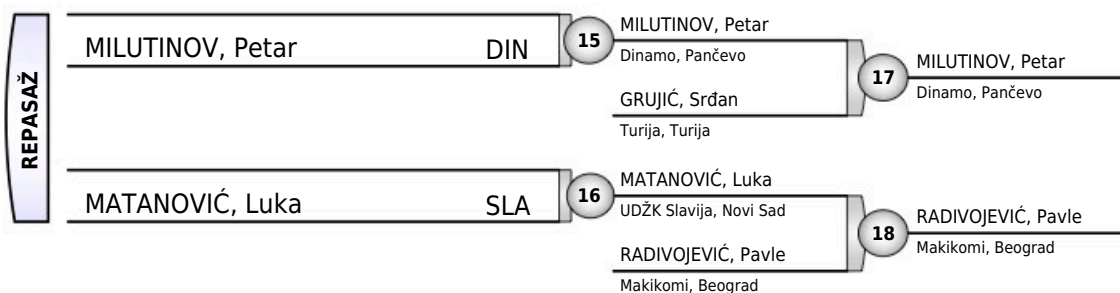



TROFEJ GRADA PANČEVA

Pančevo, 19.03.2022.

MLAĐI DEČACI

-34KG

18 takmičara

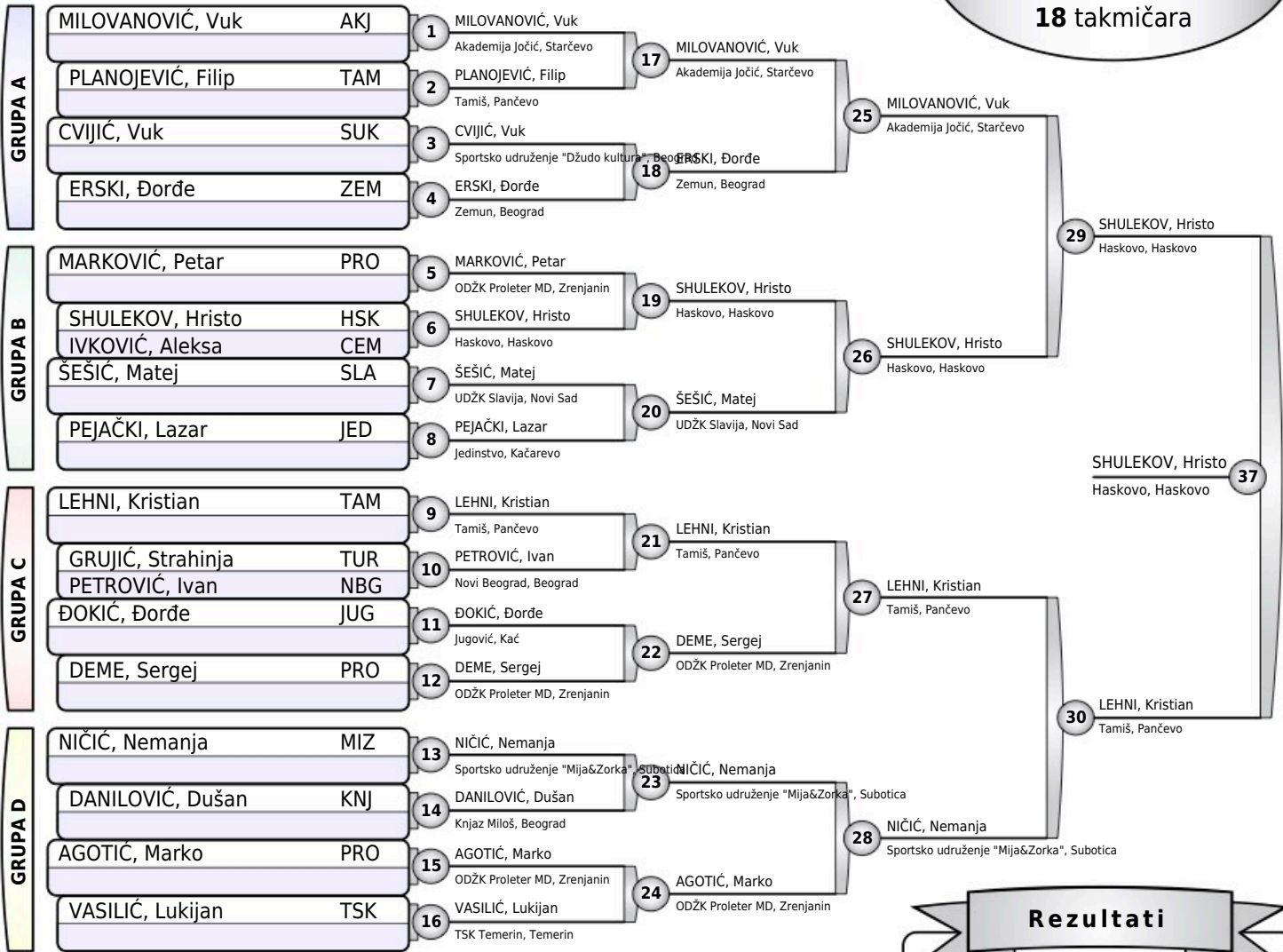

Rezultati

- SHULEKOV, Hristo (HSK)
- LEHNI, Kristian (TAM)
- MARKOVIĆ, Petar (PRO)
- NIČIĆ, Nemanja (MIZ)
- MILOVANOVIĆ, Vuk (AKJ)
- DEME, Sergej (PRO)
- ŠEŠIĆ, Matej (SLA)
- PETROVIĆ, Ivan (NBG)

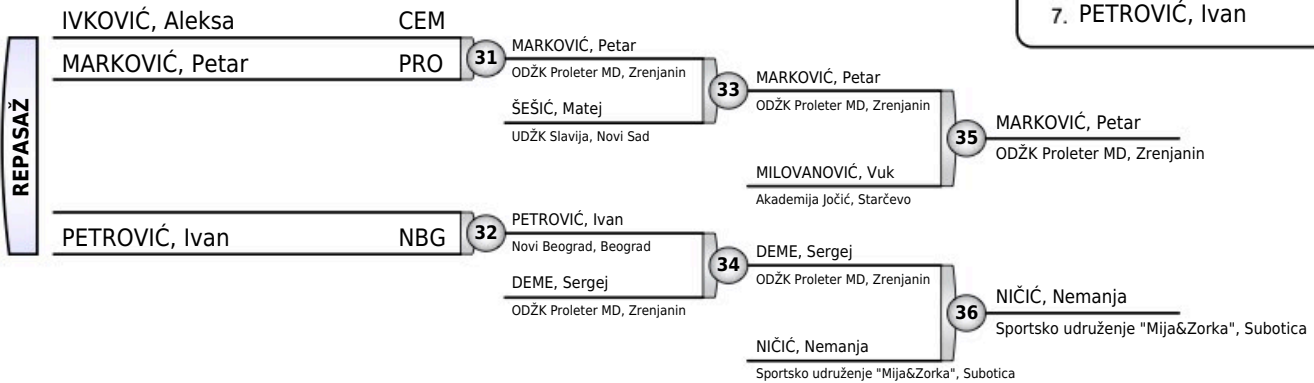



TROFEJ GRADA PANČEVA

Pančevo, 19.03.2022.

MLAĐI DEČACI

-38KG

21 takmičar

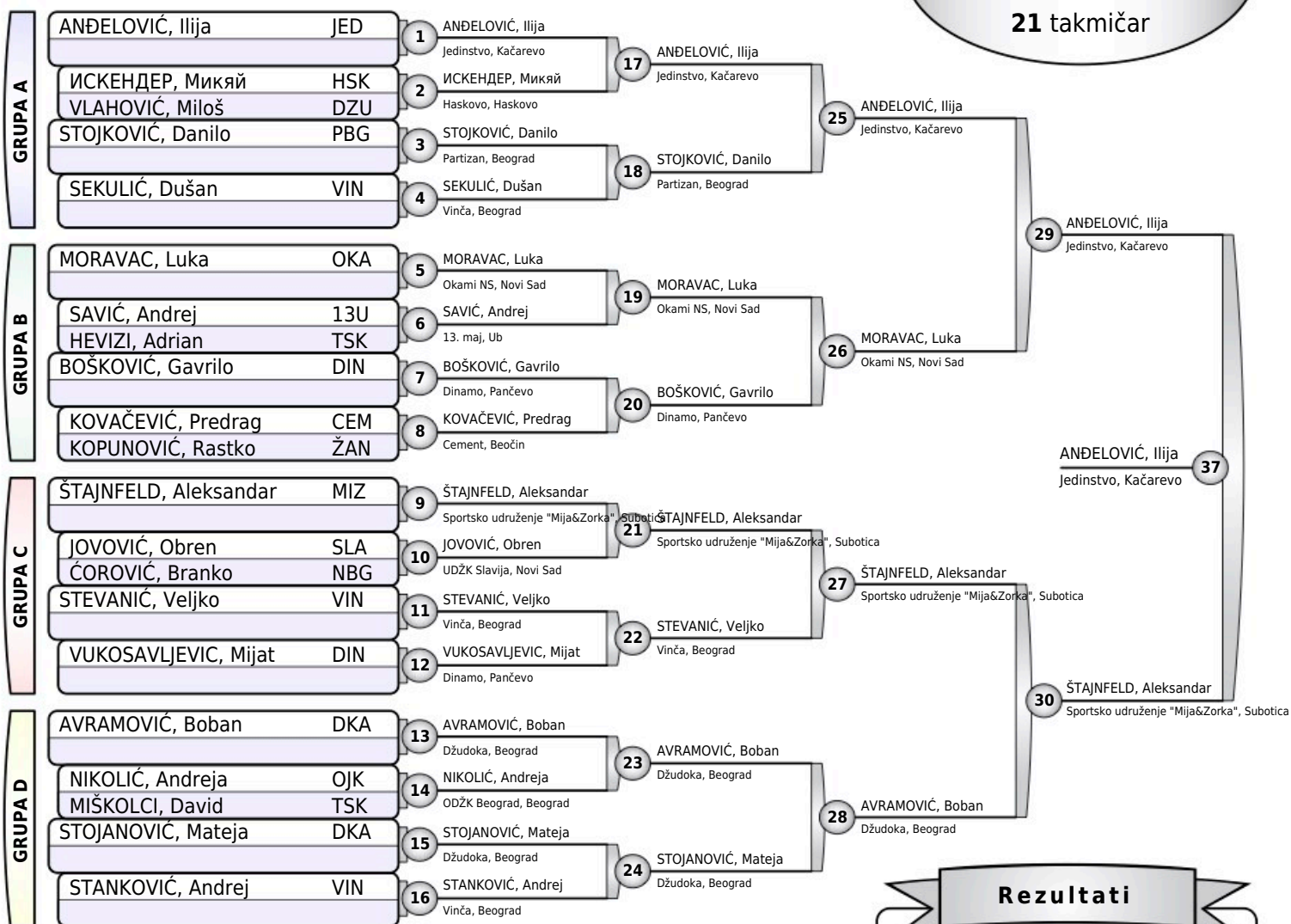

Rezultati

1. ANĐELOVIĆ, Ilija JED
2. ŠTAJNFELD, Aleksandar MIZ
3. STOJKOVIĆ, Danilo PBG
3. AVRAMOVIĆ, Boban DKA
5. MORAVAC, Luka OKA
5. STEVANIĆ, Veljko VIN
7. ИСКЕНДЕР, Микяй HSK
7. JOVOVIĆ, Obren SLA



TROFEJ GRADA PANČEVA

Pančevo, 19.03.2022.

MLAĐI DEČACI

-42KG

15 takmičara

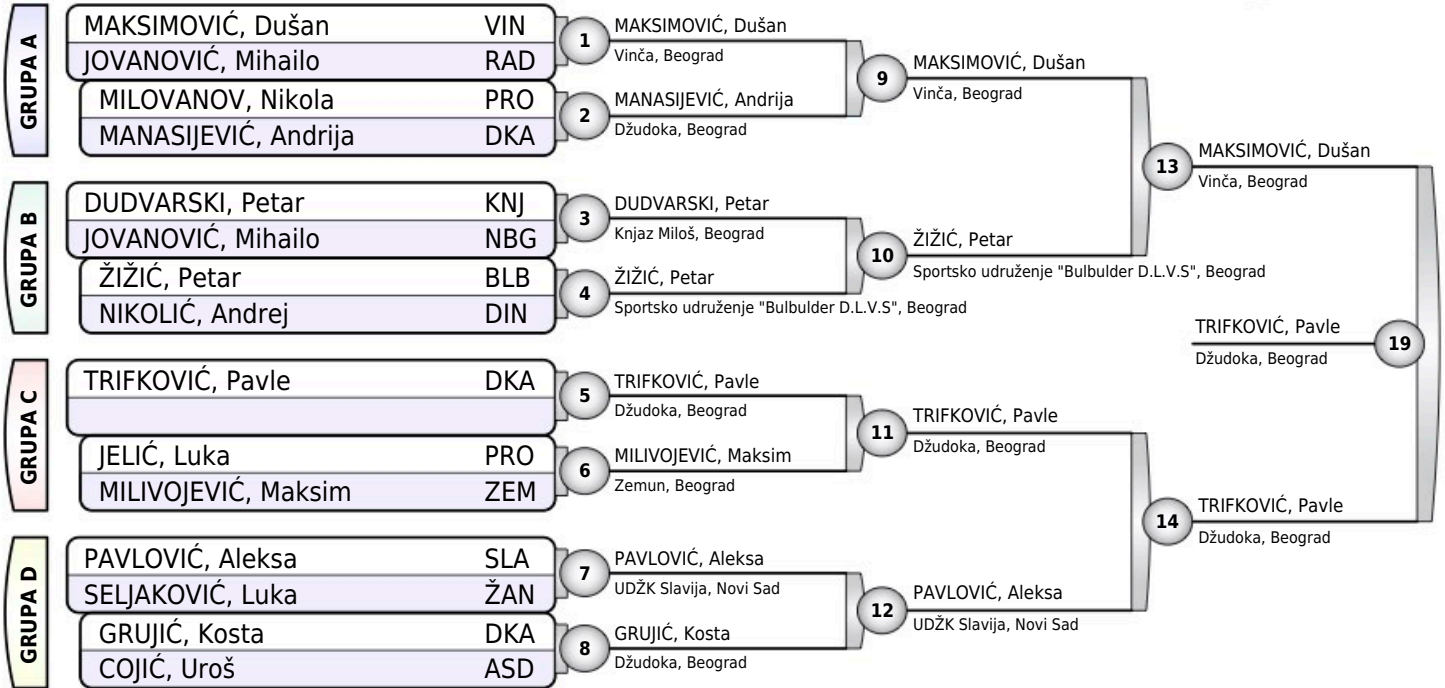

Rezultati

- TRIFKOVIĆ, Pavle DKA
- MAKSIMOVIĆ, Dušan VIN
- ŽIŽIĆ, Petar BLB
- PAVLOVIĆ, Aleksa SLA
- MANASIJEVIĆ, Andrija DKA
- MILIVOJEVIĆ, Maksim ZEM
- JOVANOVIĆ, Mihailo RAD
-





TROFEJ GRADA PANČEVA

Pančevo, 19.03.2022.

MLAĐI DEČACI

-46KG

14 takmičara

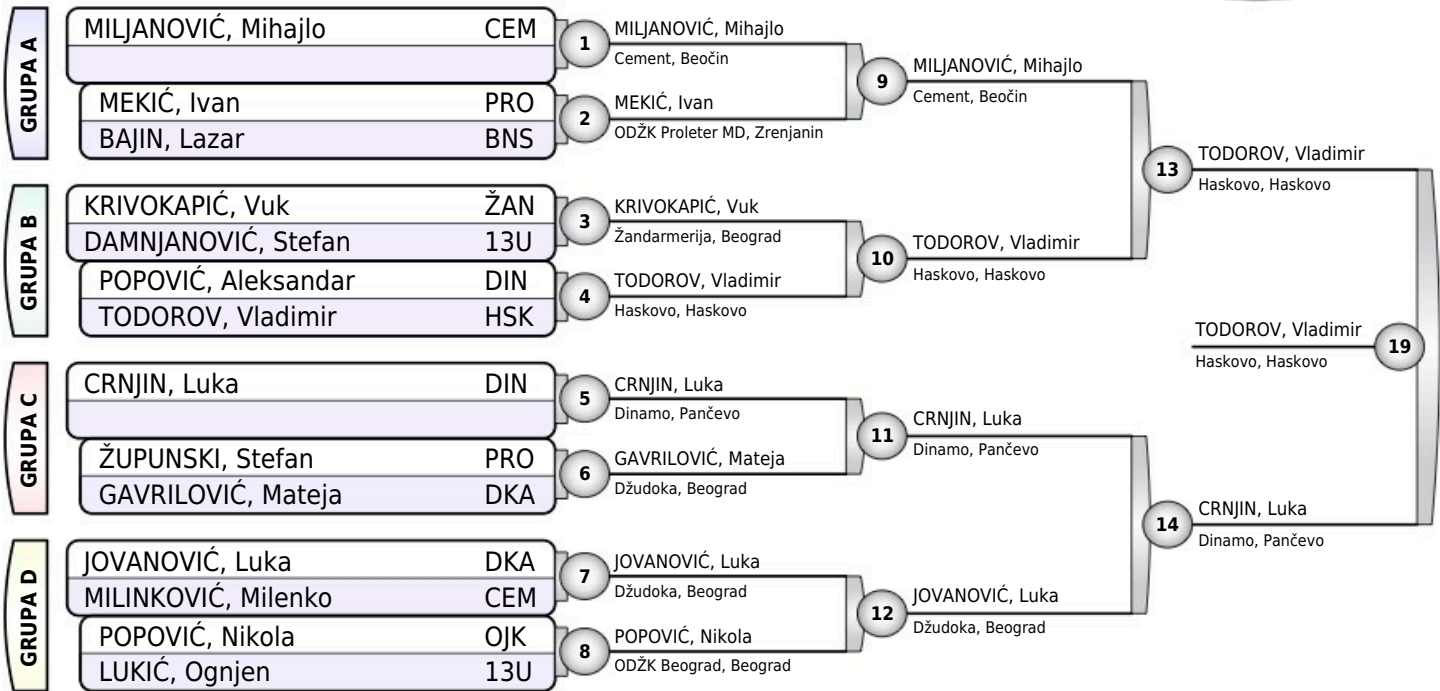

Rezultati

1. TODOROV, Vladimir HSK
2. CRNJIN, Luka DIN
3. MILJANOVIĆ, Mihajlo CEM
3. JOVANOVIĆ, Luka DKA
5. POPOVIĆ, Aleksandar DIN
5. GAVRILOVIĆ, Mateja DKA
7. KRIVOKAPIĆ, Vuk ŽAN
- 7.

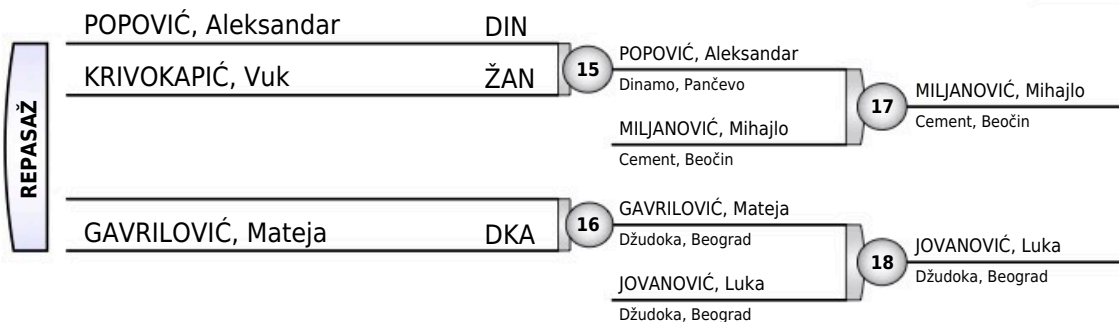



TROFEJ GRADA PANČEVA

Pančevo, 19.03.2022.

MLAĐI DEČACI

-50KG

11 takmičara

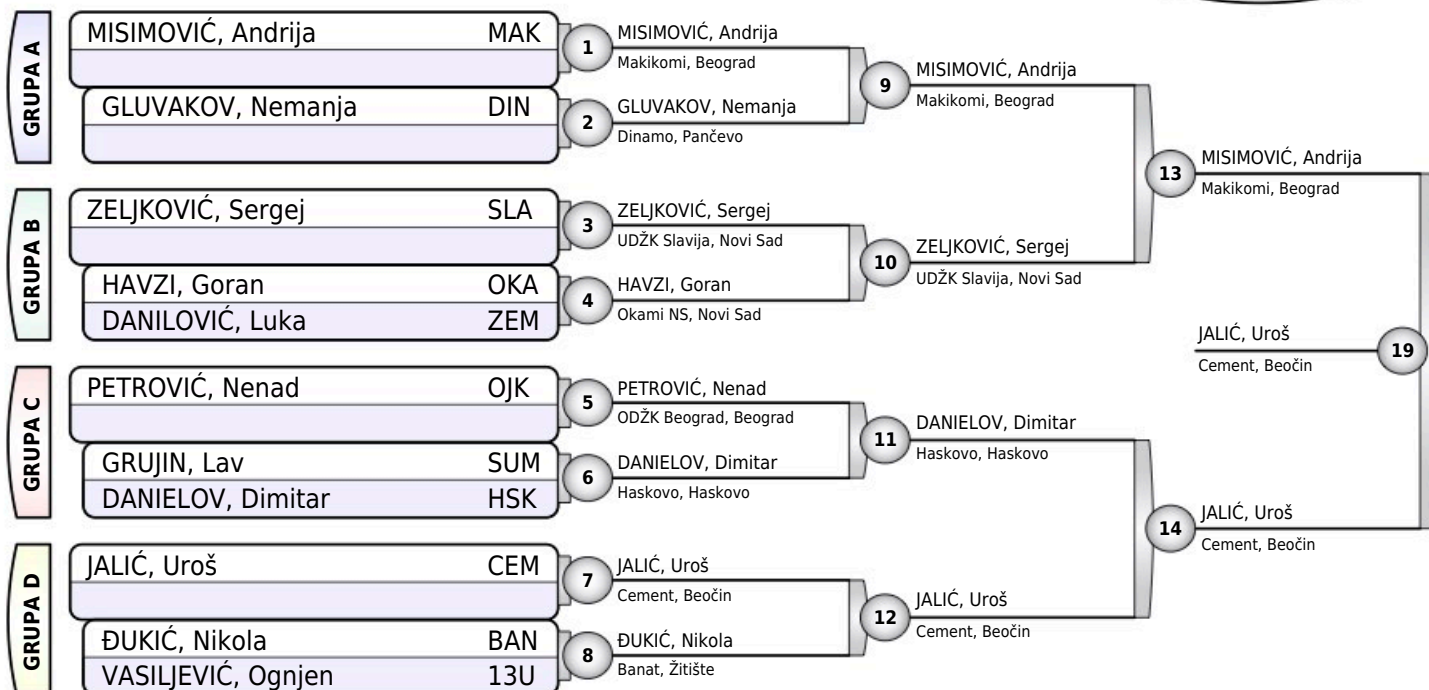

Rezultati

- JALIĆ, Uroš CEM
- MISIMOVIĆ, Andrija MAK
- ZELJKOVIĆ, Sergej SLA
- DANIELOV, Dimitar HSK
- GLUVAKOV, Nemanja DIN
- ĐUKIĆ, Nikola BAN
-
-





TROFEJ GRADA PANČEVA

Pančevo, 19.03.2022.

MLAĐI DEČACI

-55KG

7 takmičara

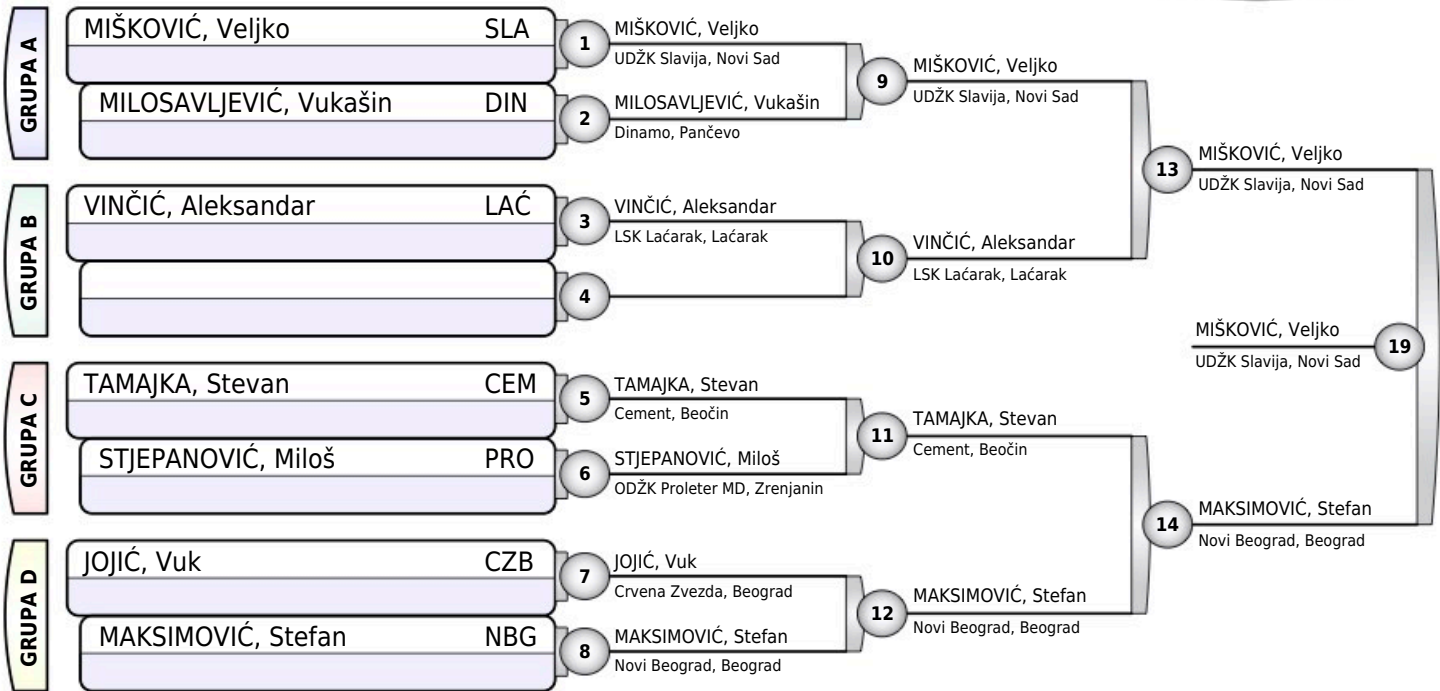

Rezultati

1. MIŠKOVIĆ, Veljko SLA
2. MAKSIMOVIĆ, Stefan NBG
3. VINČIĆ, Aleksandar LAĆ
3. JOJIĆ, Vuk CZB
5. MILOSAVLJEVIĆ, Vukašin DIN
5. TAMAJKA, Stevan CEM
- 7.
- 7.

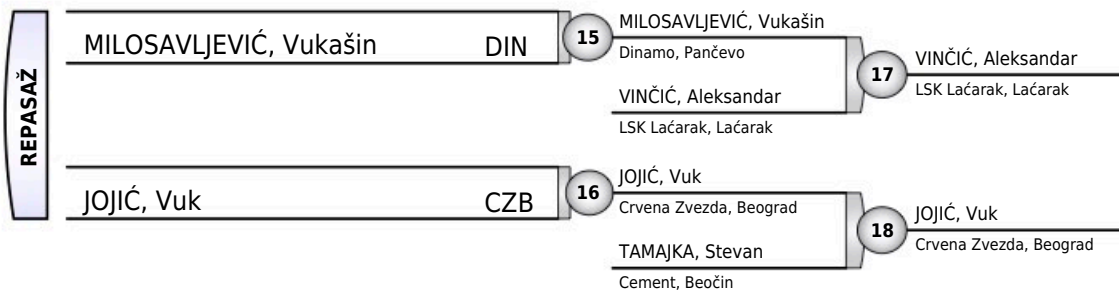



TROFEJ GRADA PANČEVA

Pančevo, 19.03.2022.

MLAĐI DEČACI

-60KG

9 takmičara

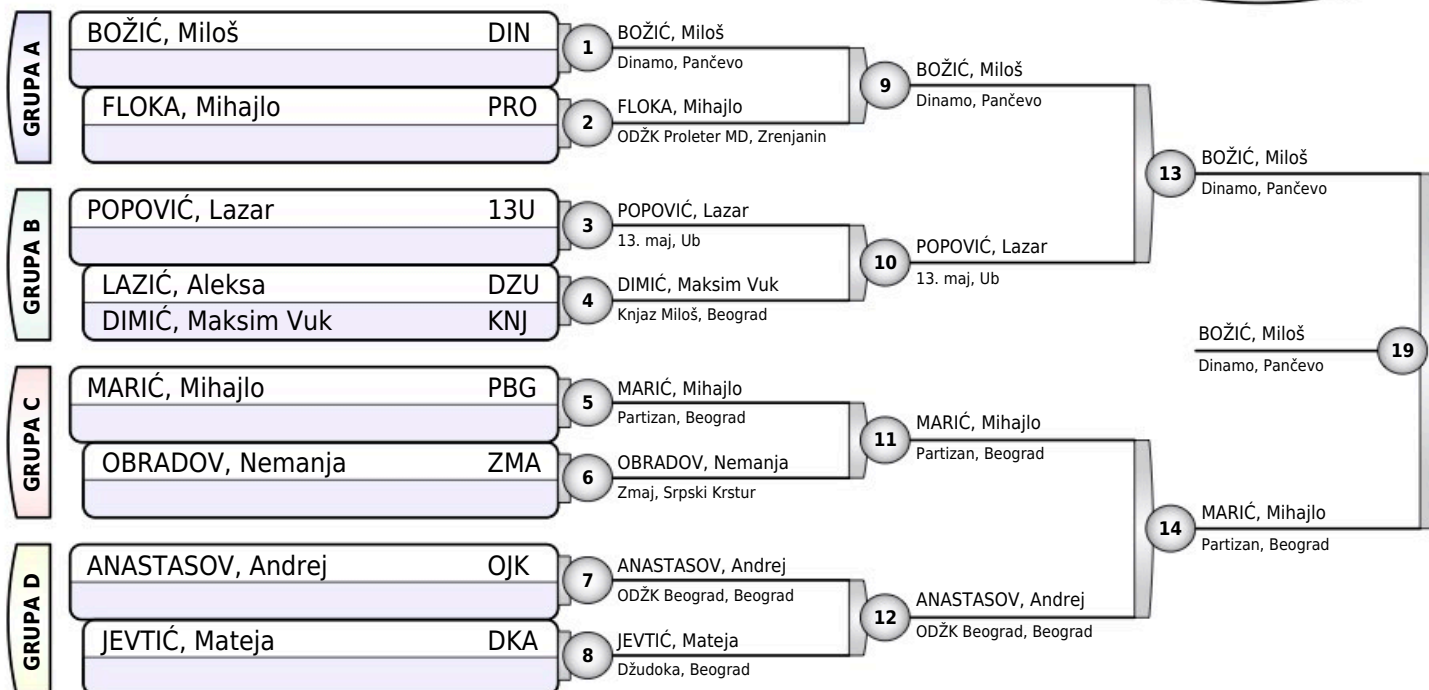

Rezultati

1. BOŽIĆ, Miloš DIN
2. MARIĆ, Mihajlo PBG
3. POPOVIĆ, Lazar 13U
3. ANASTASOV, Andrej OJK
5. FLOKA, Mihajlo PRO
5. OBRADOV, Nemanja ZMA
- 7.
- 7.

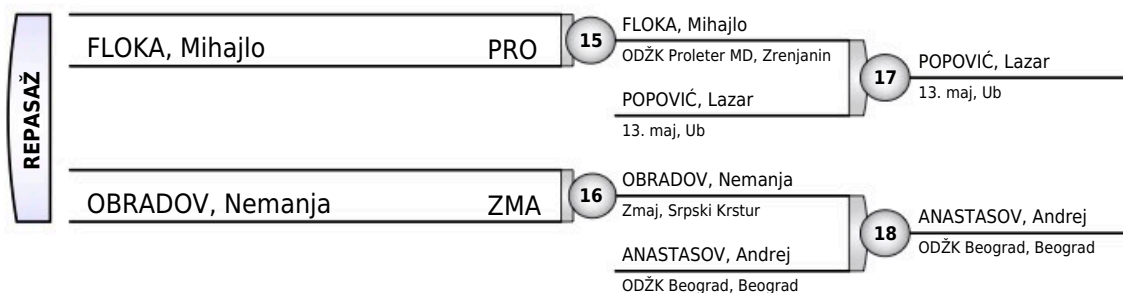



TROFEJ GRADA PANČEVA

Pančevo, 19.03.2022.

MLAĐI DEČACI

-66KG

7 takmičara

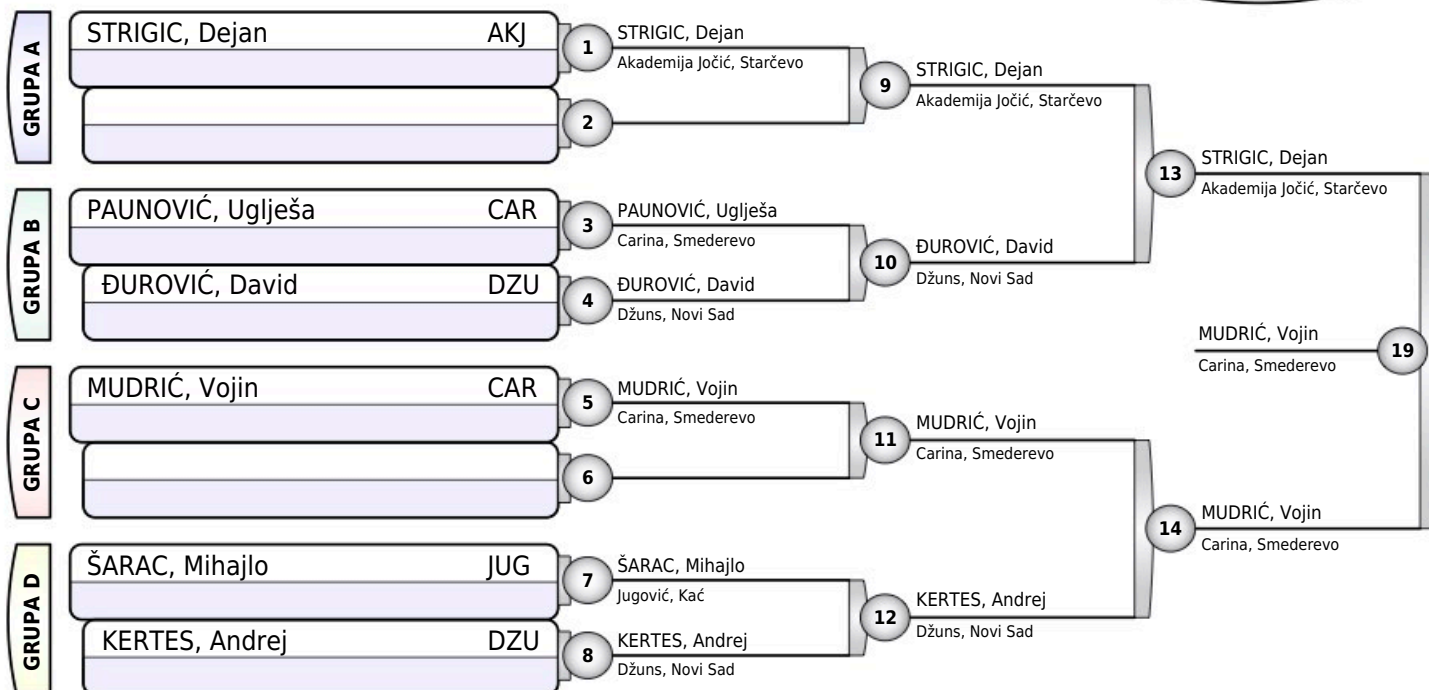

Rezultati

1. MUDRIĆ, Vojin CAR
2. STRIGIC, Dejan AKJ
3. ĐUROVIĆ, David DZU
3. KERTES, Andrej DZU
- 5.
- 5.
- 7.
- 7.

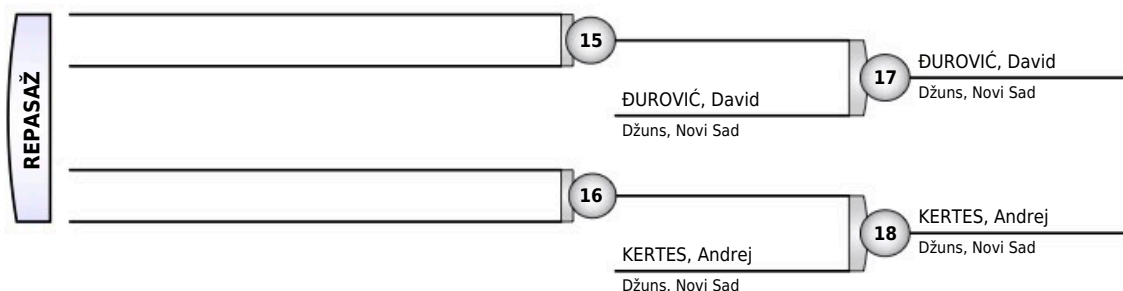



TROFEJ GRADA PANČEVA

Pančevo, 19.03.2022.

MLAĐI DEČACI

+66KG

5 takmičara

TAKMIČAR I KLUB	1	2	3	4	5	POBEDA	BODOVA	MESTO
1 KEKIĆ, Milan Mladost, Bečej		0	0	0	0	0	0	5
2 DELEVIĆ, Luka Vinča, Beograd	10		10	10	0	3	30	2
3 TIMOTIJEVIĆ, Mateja Carina, Smederevo	10	0		10	0	2	20	3
4 NIKOLIĆ, Vidak Vinča, Beograd	10	0	0		0	1	10	3
5 VUKOVIĆ, Ilija Rakovica, Beograd	10	10	10	10		4	40	1

KEKIĆ, Milan	MLA	1	DELEVIĆ, Luka
DELEVIĆ, Luka	VIN		Vinča, Beograd
TIMOTIJEVIĆ, Mateja	CAR	2	TIMOTIJEVIĆ, Mateja
NIKOLIĆ, Vidak	VIN		Carina, Smederevo
KEKIĆ, Milan	MLA	3	VUKOVIĆ, Ilija
VUKOVIĆ, Ilija	RAK		Rakovica, Beograd
DELEVIĆ, Luka	VIN	4	DELEVIĆ, Luka
TIMOTIJEVIĆ, Mateja	CAR		Vinča, Beograd
NIKOLIĆ, Vidak	VIN	5	VUKOVIĆ, Ilija
VUKOVIĆ, Ilija	RAK		Rakovica, Beograd
KEKIĆ, Milan	MLA	6	TIMOTIJEVIĆ, Mateja
TIMOTIJEVIĆ, Mateja	CAR		Carina, Smederevo
DELEVIĆ, Luka	VIN	7	DELEVIĆ, Luka
NIKOLIĆ, Vidak	VIN		Vinča, Beograd
TIMOTIJEVIĆ, Mateja	CAR	8	VUKOVIĆ, Ilija
VUKOVIĆ, Ilija	RAK		Rakovica, Beograd
KEKIĆ, Milan	MLA	9	NIKOLIĆ, Vidak
NIKOLIĆ, Vidak	VIN		Vinča, Beograd
DELEVIĆ, Luka	VIN	10	VUKOVIĆ, Ilija
VUKOVIĆ, Ilija	RAK		Rakovica, Beograd

Rezultati

- | | |
|------------------------|-----|
| 1. VUKOVIĆ, Ilija | RAK |
| 2. DELEVIĆ, Luka | VIN |
| 3. TIMOTIJEVIĆ, Mateja | CAR |
| 3. NIKOLIĆ, Vidak | VIN |
| 5. KEKIĆ, Milan | MLA |



TROFEJ GRADA PANČEVA

Pančevo, 19.03.2022.

MLAĐE DEVOJČICE

-32KG

3 takmičarke

TAKMIČAR I KLUB	1	2	3	POBEDA	BODOVA	MESTO
1 NASKOVIĆ, Nina Voždovac, Beograd		10	10	2	20	1
2 JELIĆ, Višnja 13. maj, Ub	0		10	1	10	2
3 VUKMIROVIĆ, Hana Makikomi, Beograd	0	0		0	0	3

NASKOVIĆ, Nina	VOŽ	1	NASKOVIĆ, Nina
JELIĆ, Višnja	13U		Voždovac, Beograd
NASKOVIĆ, Nina	VOŽ	2	NASKOVIĆ, Nina
VUKMIROVIĆ, Hana	MAK		Voždovac, Beograd
JELIĆ, Višnja	13U	3	JELIĆ, Višnja
VUKMIROVIĆ, Hana	MAK		13. maj, Ub

Rezultati

1. NASKOVIĆ, Nina VOŽ
2. JELIĆ, Višnja 13U
3. VUKMIROVIĆ, Hana MAK



TROFEJ GRADA PANČEVA

Pančevo, 19.03.2022.

MLAĐE DEVOJČICE

-36KG

3 takmičarke

TAKMIČAR I KLUB	1	2	3	POBEDA	BODOVA	MESTO
1 AĆIMOVIĆ, Ljubica Bambi, Požarevac		0	0	0	0	3
2 VORKAPIĆ, Jovana LSK Lačarak, Lačarak	10		10	2	20	1
3 RELATIĆ, Adrijana Zmaj, Srpski Krstur	10	0		1	10	2

AĆIMOVIĆ, Ljubica	BAM	1	VORKAPIĆ, Jovana
VORKAPIĆ, Jovana	LAĆ		LSK Lačarak, Lačarak
AĆIMOVIĆ, Ljubica	BAM	2	RELATIĆ, Adrijana
RELATIĆ, Adrijana	ZMA		Zmaj, Srpski Krstur
VORKAPIĆ, Jovana	LAĆ	3	VORKAPIĆ, Jovana
RELATIĆ, Adrijana	ZMA		LSK Lačarak, Lačarak

Rezultati

- | | |
|----------------------|-----|
| 1. VORKAPIĆ, Jovana | LAĆ |
| 2. RELATIĆ, Adrijana | ZMA |
| 3. AĆIMOVIĆ, Ljubica | BAM |



TROFEJ GRADA PANČEVA

Pančevo, 19.03.2022.

MLAĐE DEVOJČICE

-40KG

7 takmičarki

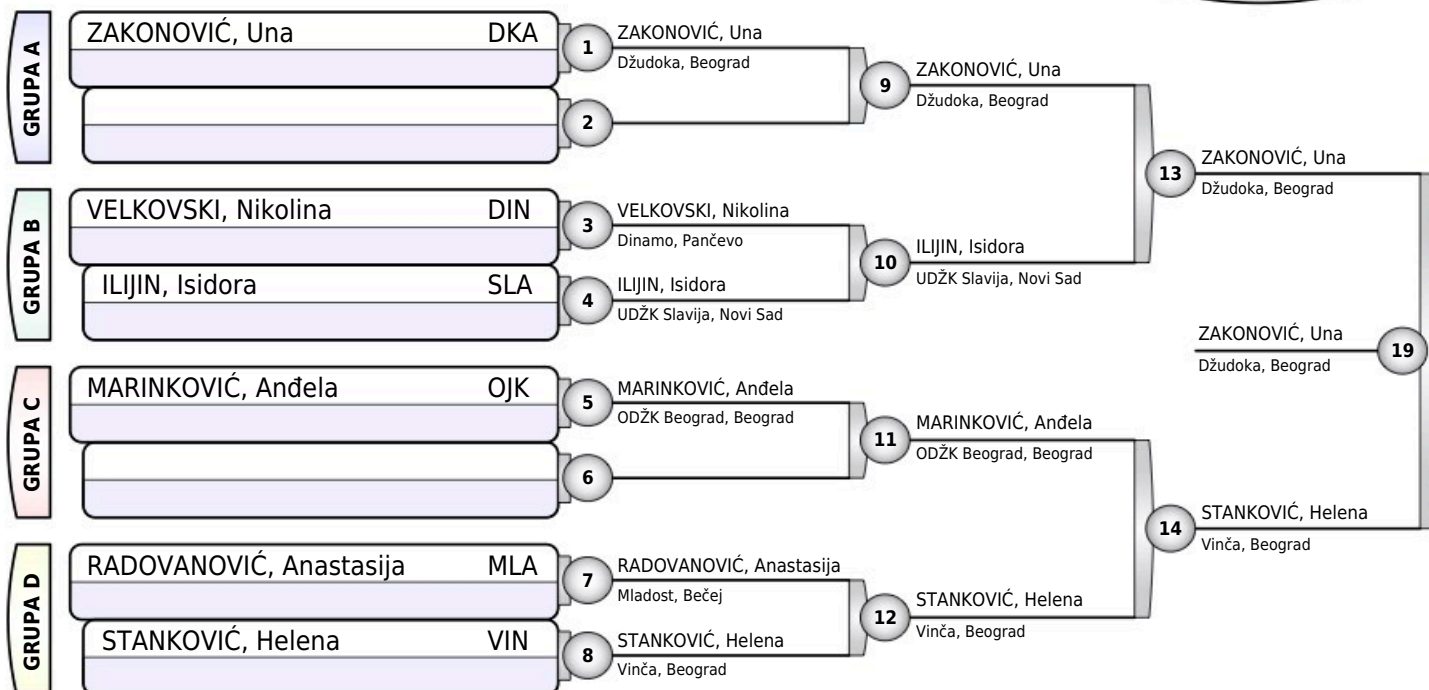

Rezultati

1. ZAKONOVIĆ, Una DKA
2. STANKOVIĆ, Helena VIN
3. MARINKOVIĆ, Anđela OJK
3. ILIJIN, Isidora SLA
5. RADOVANOVIĆ, Anastasija MLA
- 5.
- 7.
- 7.

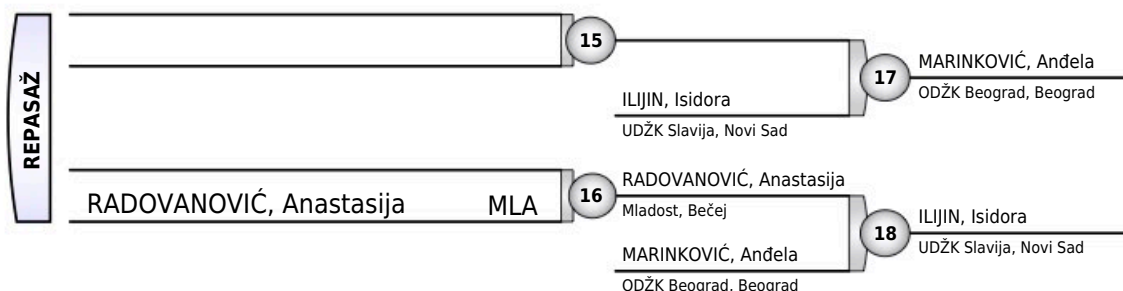



TROFEJ GRADA PANČEVA

Pančevo, 19.03.2022.

MLAĐE DEVOJČICE

-44KG

8 takmičarki

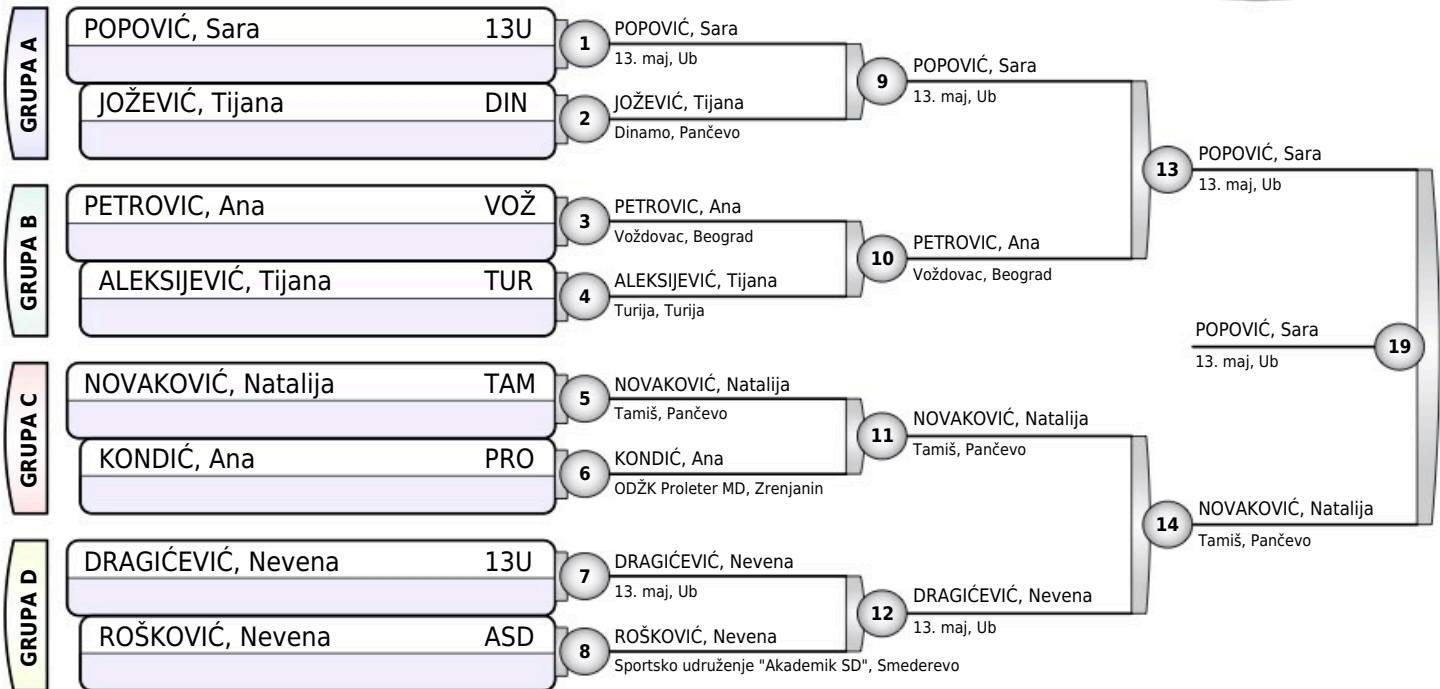

Rezultati

1. POPOVIĆ, Sara 13U
2. NOVAKOVIĆ, Natalija TAM
3. PETROVIC, Ana VOŽ
3. DRAGIĆEVIĆ, Nevena 13U
5. JOŽEVIĆ, Tijana DIN
5. KONDIĆ, Ana PRO
- 7.
- 7.





TROFEJ GRADA PANČEVA

Pančevo, 19.03.2022.

MLAĐE DEVOJČICE

-48KG

7 takmičarki

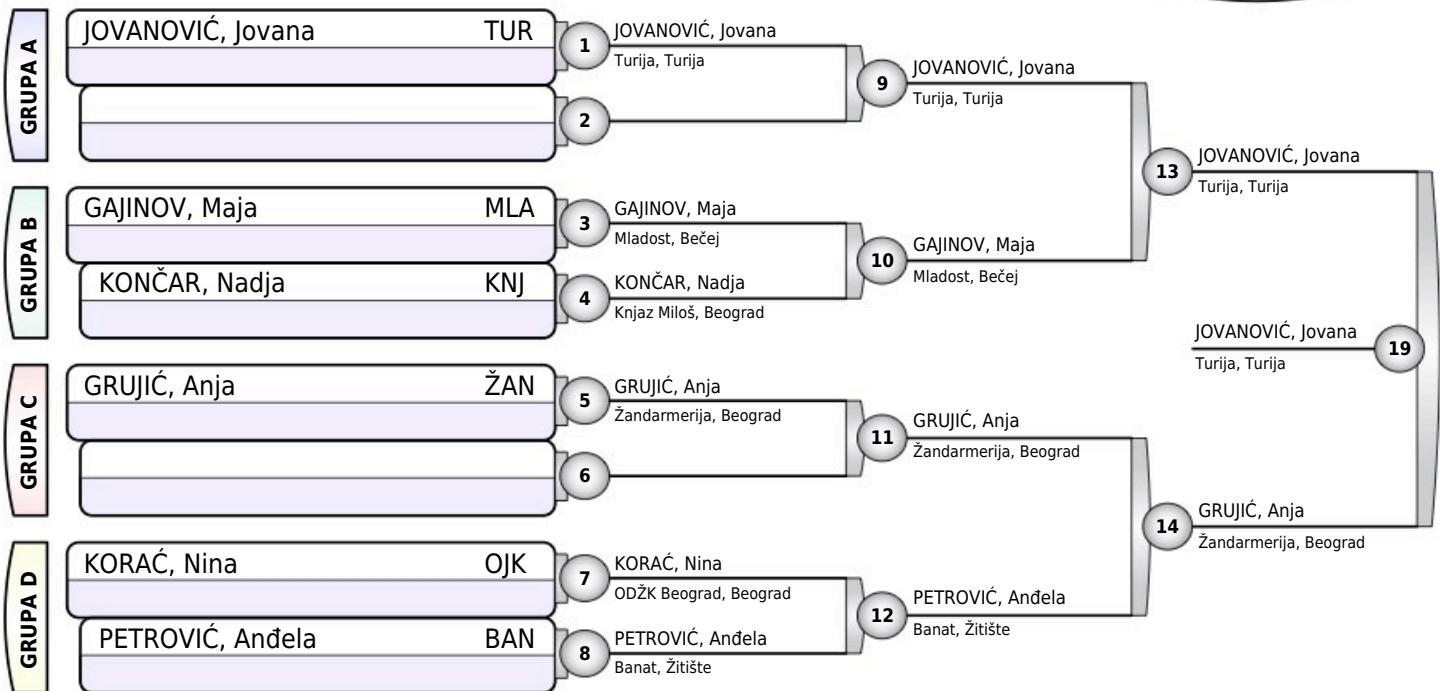

Rezultati

1. JOVANOVIĆ, Jovana TUR
2. GRUJIĆ, Anja ŽAN
3. GAJINOV, Maja MLA
3. PETROVIĆ, Anđela BAN
- 5.
- 5.
- 7.
- 7.



TROFEJ GRADA PANČEVA

Pančevo, 19.03.2022.

MLAĐE DEVOJČICE

-52KG

5 takmičarki

TAKMIČAR I KLUB	1	2	3	4	5	POBEDA	BODOVA	MESTO
1 VULOVIC, Milica Knjaz Miloš, Beograd	---	0	0	0	0	0	0	5
2 VIRAG, Jovana Turija, Turija	10	---	10	10	10	4	40	1
3 ARSIĆ, Natalija Žandarmerija, Beograd	10	0	---	10	0	2	20	3
4 BANĐUR, Nikolina ODŽK Beograd, Beograd	10	0	0	---	0	1	10	3
5 VOJVODIĆ, Dunja Žandarmerija, Beograd	10	0	10	10	---	3	30	2

VULOVIC, Milica	KNJ	1	VIRAG, Jovana
VIRAG, Jovana	TUR		Turija, Turija
ARSIĆ, Natalija	ŽAN	2	ARSIĆ, Natalija
BANĐUR, Nikolina	OJK		Žandarmerija, Beograd
VULOVIC, Milica	KNJ	3	VOJVODIĆ, Dunja
VOJVODIĆ, Dunja	ŽAN		Žandarmerija, Beograd
VIRAG, Jovana	TUR	4	VIRAG, Jovana
ARSIĆ, Natalija	ŽAN		Turija, Turija
BANĐUR, Nikolina	OJK	5	VOJVODIĆ, Dunja
VOJVODIĆ, Dunja	ŽAN		Žandarmerija, Beograd
VULOVIC, Milica	KNJ	6	ARSIĆ, Natalija
ARSIĆ, Natalija	ŽAN		Žandarmerija, Beograd
VIRAG, Jovana	TUR	7	VIRAG, Jovana
BANĐUR, Nikolina	OJK		Turija, Turija
ARSIĆ, Natalija	ŽAN	8	VOJVODIĆ, Dunja
VOJVODIĆ, Dunja	ŽAN		Žandarmerija, Beograd
VULOVIC, Milica	KNJ	9	BANĐUR, Nikolina
BANĐUR, Nikolina	OJK		ODŽK Beograd, Beograd
VIRAG, Jovana	TUR	10	VIRAG, Jovana
VOJVODIĆ, Dunja	ŽAN		Turija, Turija

Rezultati

- | | |
|---------------------|-----|
| 1. VIRAG, Jovana | TUR |
| 2. VOJVODIĆ, Dunja | ŽAN |
| 3. ARSIĆ, Natalija | ŽAN |
| 3. BANĐUR, Nikolina | OJK |
| 5. VULOVIC, Milica | KNJ |



TROFEJ GRADA PANČEVA

Pančevo, 19.03.2022.

MLAĐE DEVOJČICE

+56KG

5 takmičarki

TAKMIČAR I KLUB	1	2	3	4	5	POBEDA	BODOVA	MESTO
1 STEFANOVIĆ, Jana Žandarmerija, Beograd		0	0	0	0	0	0	5
2 IVANOVIĆ, Nikolina Mladost Carina, Smederevo	10		10	10	10	4	40	1
3 PEJIĆ, Milica Makikomi, Beograd	10	0		0	10	2	20	3
4 KOVAČEVIĆ, Lena Banat, Žitište	10	0	10		0	2	20	2
5 PAUNOVIĆ, Helena Kučevo, Kučevo	10	0	0	10		2	20	3

STEFANOVIĆ, Jana	ŽAN	1	IVANOVIĆ, Nikolina
IVANOVIĆ, Nikolina	MLC		Mladost Carina, Smederevo
PEJIĆ, Milica	MAK	2	KOVAČEVIĆ, Lena
KOVAČEVIĆ, Lena	BAN		Banat, Žitište
STEFANOVIĆ, Jana	ŽAN	3	PAUNOVIĆ, Helena
PAUNOVIĆ, Helena	KUČ		Kučevo, Kučevo
IVANOVIĆ, Nikolina	MLC	4	IVANOVIĆ, Nikolina
PEJIĆ, Milica	MAK		Mladost Carina, Smederevo
KOVAČEVIĆ, Lena	BAN	5	PAUNOVIĆ, Helena
PAUNOVIĆ, Helena	KUČ		Kučevo, Kučevo
STEFANOVIĆ, Jana	ŽAN	6	PEJIĆ, Milica
PEJIĆ, Milica	MAK		Makikomi, Beograd
IVANOVIĆ, Nikolina	MLC	7	IVANOVIĆ, Nikolina
KOVAČEVIĆ, Lena	BAN		Mladost Carina, Smederevo
PEJIĆ, Milica	MAK	8	PEJIĆ, Milica
PAUNOVIĆ, Helena	KUČ		Makikomi, Beograd
STEFANOVIĆ, Jana	ŽAN	9	KOVAČEVIĆ, Lena
KOVAČEVIĆ, Lena	BAN		Banat, Žitište
IVANOVIĆ, Nikolina	MLC	10	IVANOVIĆ, Nikolina
PAUNOVIĆ, Helena	KUČ		Mladost Carina, Smederevo

Rezultati

- | | |
|-----------------------|-----|
| 1. IVANOVIĆ, Nikolina | MLC |
| 2. KOVAČEVIĆ, Lena | BAN |
| 3. PEJIĆ, Milica | MAK |
| 3. PAUNOVIĆ, Helena | KUČ |
| 5. STEFANOVIĆ, Jana | ŽAN |



TROFEJ GRADA PANČEVA

Pančevo, 19.03.2022.

STARIJI DEČACI

-34KG

4 takmičara

TAKMIČAR I KLUB	1	2	3	4	POBEDA	BODOVA	MESTO
1 GRUJIĆ, Matija Knjaz Miloš, Beograd		0	0	0	0	0	3
2 STOJIC, Petar Dinamo, Pančevo	10		10	10	3	30	1
3 NEDELJKOVIĆ, Dimitrije Banat, Žitište	10	0		0	1	10	3
4 VUKOVIĆ, Mihajlo Tamiš, Pančevo	10	0	1		2	11	2

GRUJIĆ, Matija	KNJ	1	STOJIC, Petar
STOJIC, Petar	DIN		Dinamo, Pančevo
NEDELJKOVIĆ, Dimitrije	BAN	2	VUKOVIĆ, Mihajlo
VUKOVIĆ, Mihajlo	TAM		Tamiš, Pančevo
GRUJIĆ, Matija	KNJ	3	NEDELJKOVIĆ, Dimitrije
NEDELJKOVIĆ, Dimitrije	BAN		Banat, Žitište
STOJIC, Petar	DIN	4	STOJIC, Petar
VUKOVIĆ, Mihajlo	TAM		Dinamo, Pančevo
GRUJIĆ, Matija	KNJ	5	VUKOVIĆ, Mihajlo
VUKOVIĆ, Mihajlo	TAM		Tamiš, Pančevo
STOJIC, Petar	DIN	6	STOJIC, Petar
NEDELJKOVIĆ, Dimitrije	BAN		Dinamo, Pančevo

Rezultati

1. STOJIC, Petar DIN
2. VUKOVIĆ, Mihajlo TAM
3. NEDELJKOVIĆ, Dimitrije BAN
3. GRUJIĆ, Matija KNJ



TROFEJ GRADA PANČEVA

Pančevo, 19.03.2022.

STARIJI DEČACI

-38KG

3 takmičara

TAKMIČAR I KLUB	1	2	3	POBEDA	BODOVA	MESTO
1 ADAMOVIĆ, Dušan UDŽK Slavija, Novi Sad		0	10	1	10	2
2 NEMET, Matej Sportsko udruženje "Mija&Zorka", Subotica	10		10	2	20	1
3 ANTONIĆ, Aleksandar LSK Lačarak, Lačarak	0	0		0	0	3

ADAMOVIĆ, Dušan	SLA	1	NEMET, Matej
NEMET, Matej	MIZ		Sportsko udruženje "Mija&Zorka", Subotica
ADAMOVIĆ, Dušan	SLA	2	ADAMOVIĆ, Dušan
ANTONIĆ, Aleksandar	LAĆ		UDŽK Slavija, Novi Sad
NEMET, Matej	MIZ	3	NEMET, Matej
ANTONIĆ, Aleksandar	LAĆ		Sportsko udruženje "Mija&Zorka", Subotica

Rezultati

1. NEMET, Matej MIZ
2. ADAMOVIĆ, Dušan SLA
3. ANTONIĆ, Aleksandar LAĆ



TROFEJ GRADA PANČEVA

Pančevo, 19.03.2022.

STARIJI DEČACI

-42KG

5 takmičara

TAKMIČAR I KLUB	1	2	3	4	5	POBEDA	BODOVA	MESTO
1 STRAHINJA, Danilović Knjaz Miloš, Beograd	///	0	0	0	0	0	0	5
2 MALIŠEVIĆ, Svetozar Turija, Turija	10	///	10	0	1	3	21	2
3 SEKULIĆ, Matija Vinča, Beograd	10	0	///	0	0	1	10	3
4 ХРИСТОВ, Emo Haskovo, Haskovo	10	10	10	///	10	4	40	1
5 JOVANOVIĆ, Luka Makikomi, Beograd	10	0	10	0	///	2	20	3

STRAHINJA, Danilović	KNJ	1	MALIŠEVIĆ, Svetozar
MALIŠEVIĆ, Svetozar	TUR		Turija, Turija
SEKULIĆ, Matija	VIN	2	ХРИСТОВ, Emo
ХРИСТОВ, Emo	HSK		Haskovo, Haskovo
STRAHINJA, Danilović	KNJ	3	JOVANOVIĆ, Luka
JOVANOVIĆ, Luka	MAK		Makikomi, Beograd
MALIŠEVIĆ, Svetozar	TUR	4	MALIŠEVIĆ, Svetozar
SEKULIĆ, Matija	VIN		Turija, Turija
ХРИСТОВ, Emo	HSK	5	ХРИСТОВ, Emo
JOVANOVIĆ, Luka	MAK		Haskovo, Haskovo
STRAHINJA, Danilović	KNJ	6	SEKULIĆ, Matija
SEKULIĆ, Matija	VIN		Vinča, Beograd
MALIŠEVIĆ, Svetozar	TUR	7	ХРИСТОВ, Emo
ХРИСТОВ, Emo	HSK		Haskovo, Haskovo
SEKULIĆ, Matija	VIN	8	JOVANOVIĆ, Luka
JOVANOVIĆ, Luka	MAK		Makikomi, Beograd
STRAHINJA, Danilović	KNJ	9	ХРИСТОВ, Emo
ХРИСТОВ, Emo	HSK		Haskovo, Haskovo
MALIŠEVIĆ, Svetozar	TUR	10	MALIŠEVIĆ, Svetozar
JOVANOVIĆ, Luka	MAK		Turija, Turija

Rezultati

- | | |
|-------------------------|-----|
| 1. ХРИСТОВ, Emo | HSK |
| 2. MALIŠEVIĆ, Svetozar | TUR |
| 3. JOVANOVIĆ, Luka | MAK |
| 3. SEKULIĆ, Matija | VIN |
| 5. STRAHINJA, Danilović | KNJ |



TROFEJ GRADA PANČEVA

Pančevo, 19.03.2022.

STARIJI DEČACI

-46KG

8 takmičara

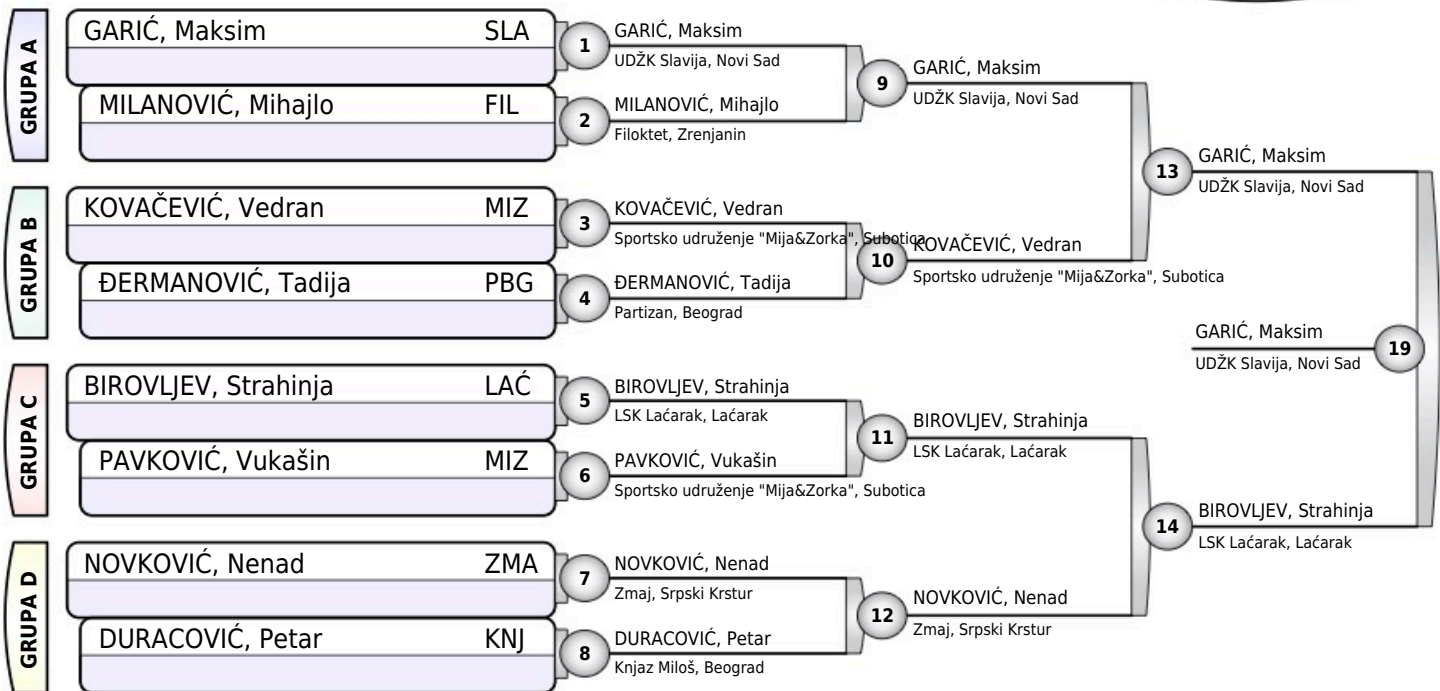

Rezultati

1. GARIĆ, Maksim SLA
2. BIROVLJEV, Strahinja LAĆ
3. MILANOVIĆ, Mihajlo FIL
3. NOVKOVIĆ, Nenad ZMA
5. KOVAČEVIĆ, Vedran MIZ
5. PAVKOVIĆ, Vukašin MIZ
- 7.
- 7.





TROFEJ GRADA PANČEVA

Pančevo, 19.03.2022.

STARIJI DEČACI

-50KG

8 takmičara

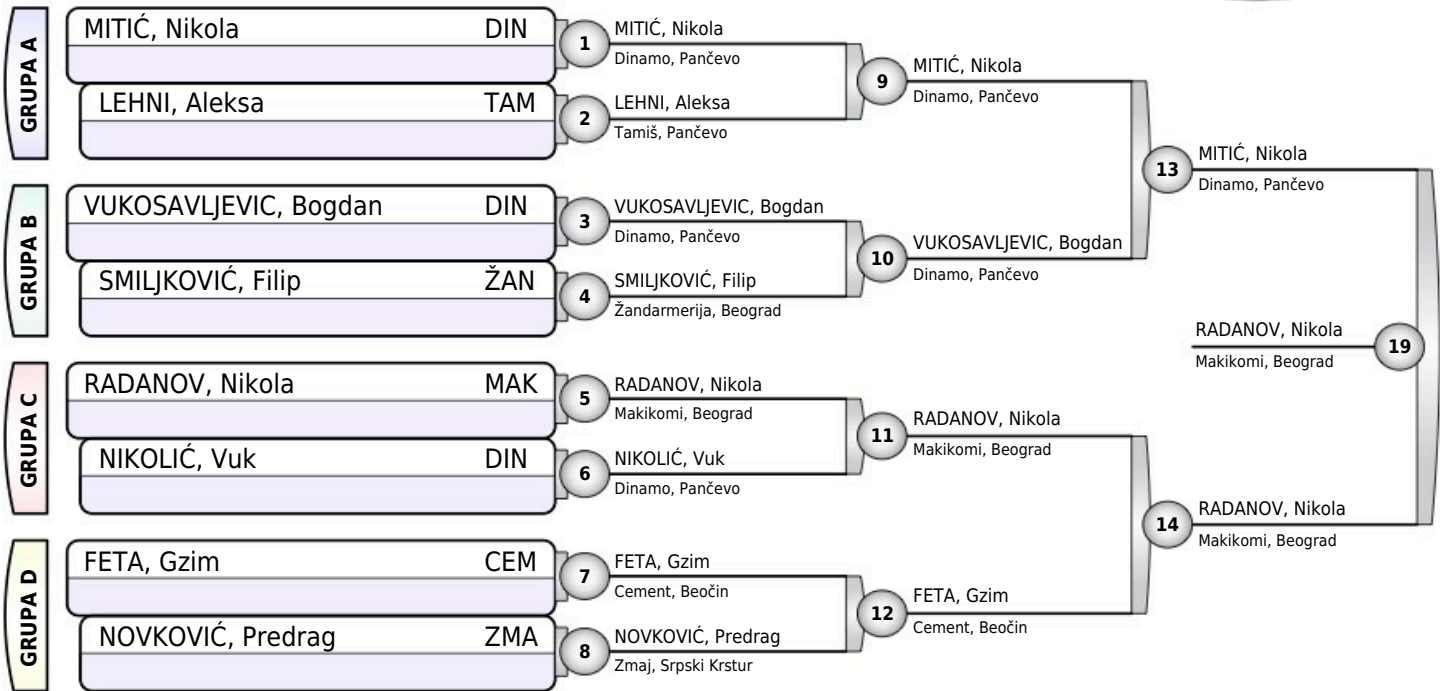

Rezultati

1. RADANOV, Nikola MAK
2. MITIĆ, Nikola DIN
3. LEHNI, Aleksa TAM
3. FETA, Gzim CEM
5. VUKOSAVLJEVIC, Bogdan DIN
5. NIKOLIĆ, Vuk DIN
- 7.
- 7.

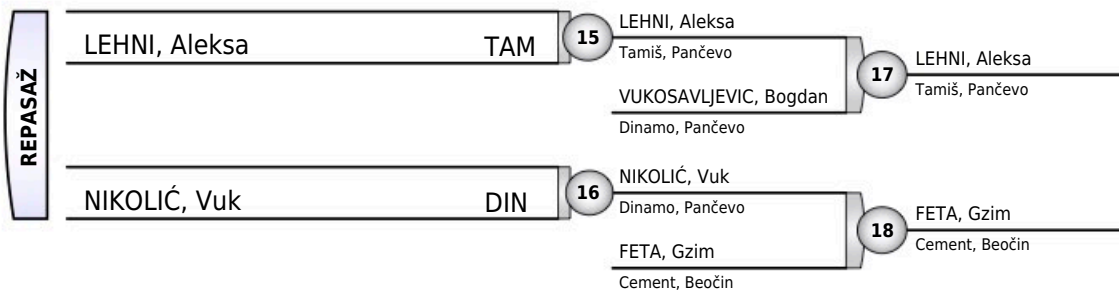



TROFEJ GRADA PANČEVA

Pančevo, 19.03.2022.

STARIJI DEČACI

-55KG

12 takmičara

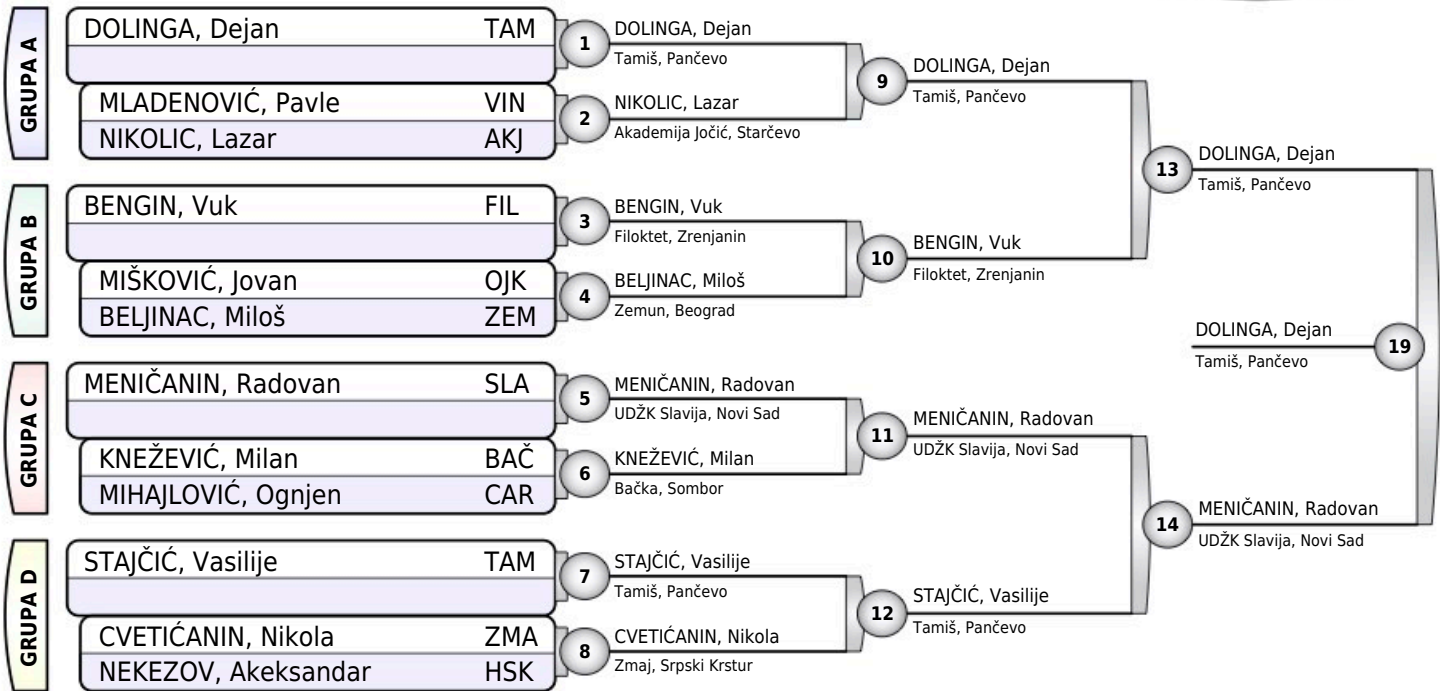

Rezultati

1. DOLINGA, Dejan TAM
2. MENIČANIN, Radovan SLA
3. BENGIN, Vuk FIL
3. STAJČIĆ, Vasilije TAM
5. NIKOLIC, Lazar AKJ
5. KNEŽEVIĆ, Milan BAČ
- 7.
- 7.

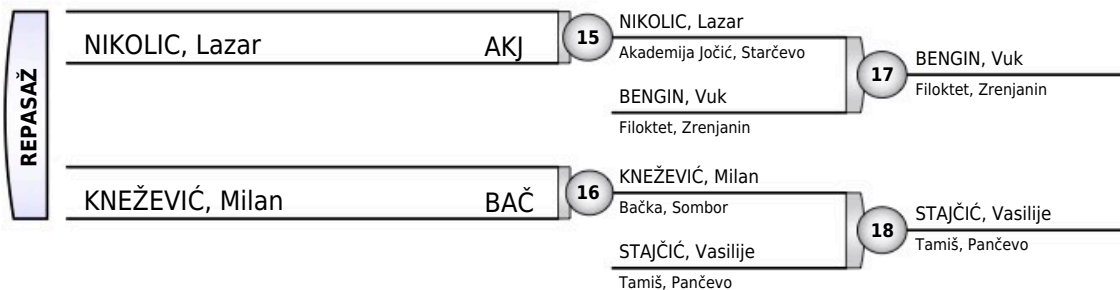



TROFEJ GRADA PANČEVA

Pančevo, 19.03.2022.

STARIJI DEČACI

-60KG

8 takmičara

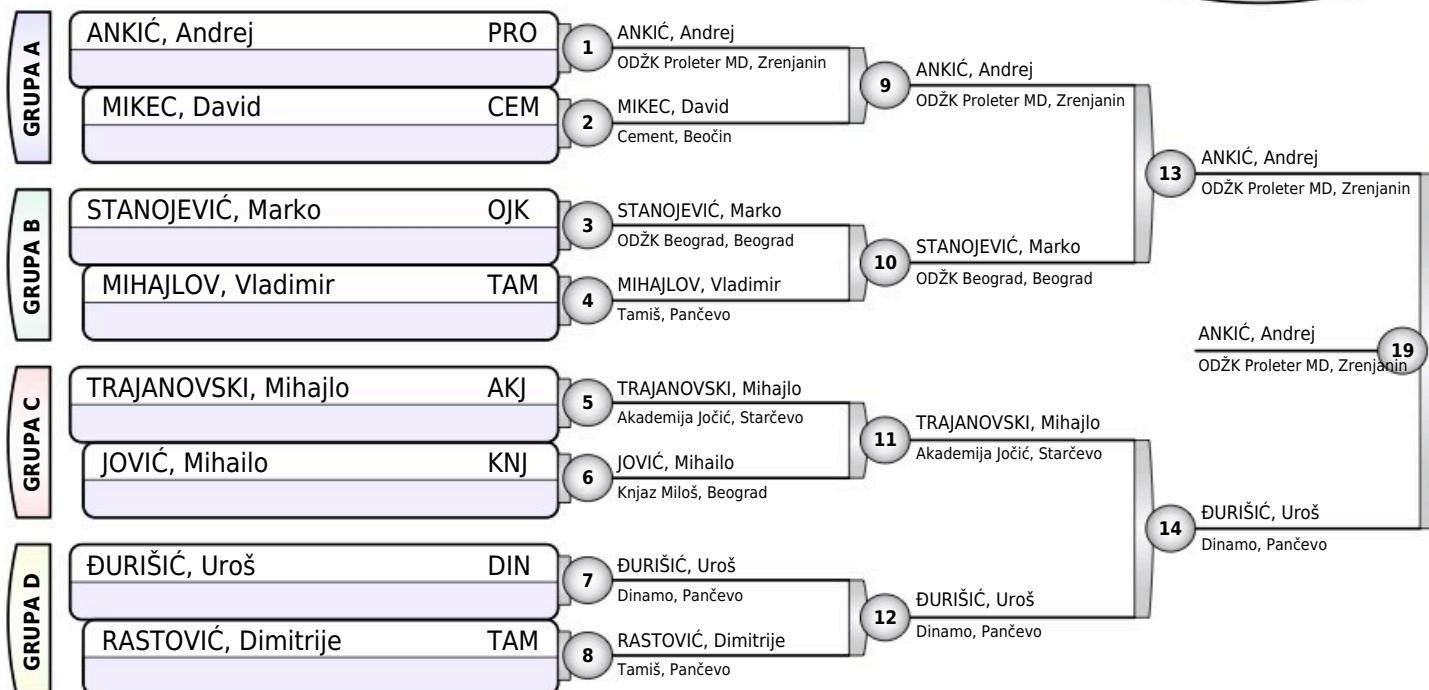

Rezultati

1. ANKIĆ, Andrej PRO
2. ĐURIŠIĆ, Uroš DIN
3. MIKEC, David CEM
3. RASTOVIĆ, Dimitrije TAM
5. STANOJEVIĆ, Marko OJK
5. TRAJANOVSKI, Mihajlo AKJ
- 7.
- 7.

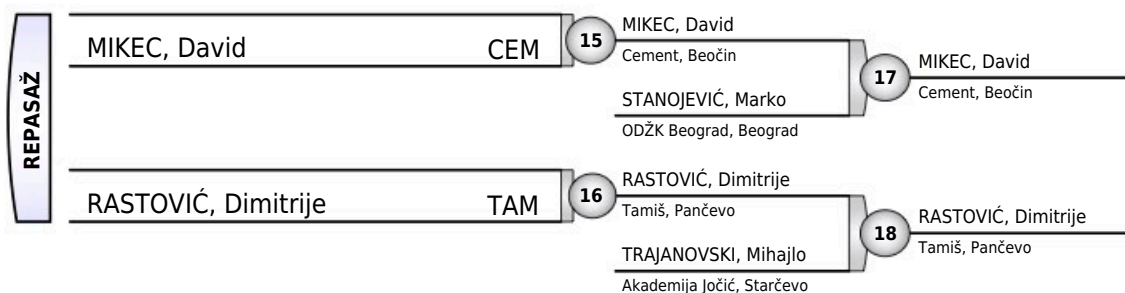



TROFEJ GRADA PANČEVA

Pančevo, 19.03.2022.

STARIJI DEČACI

-66KG

9 takmičara

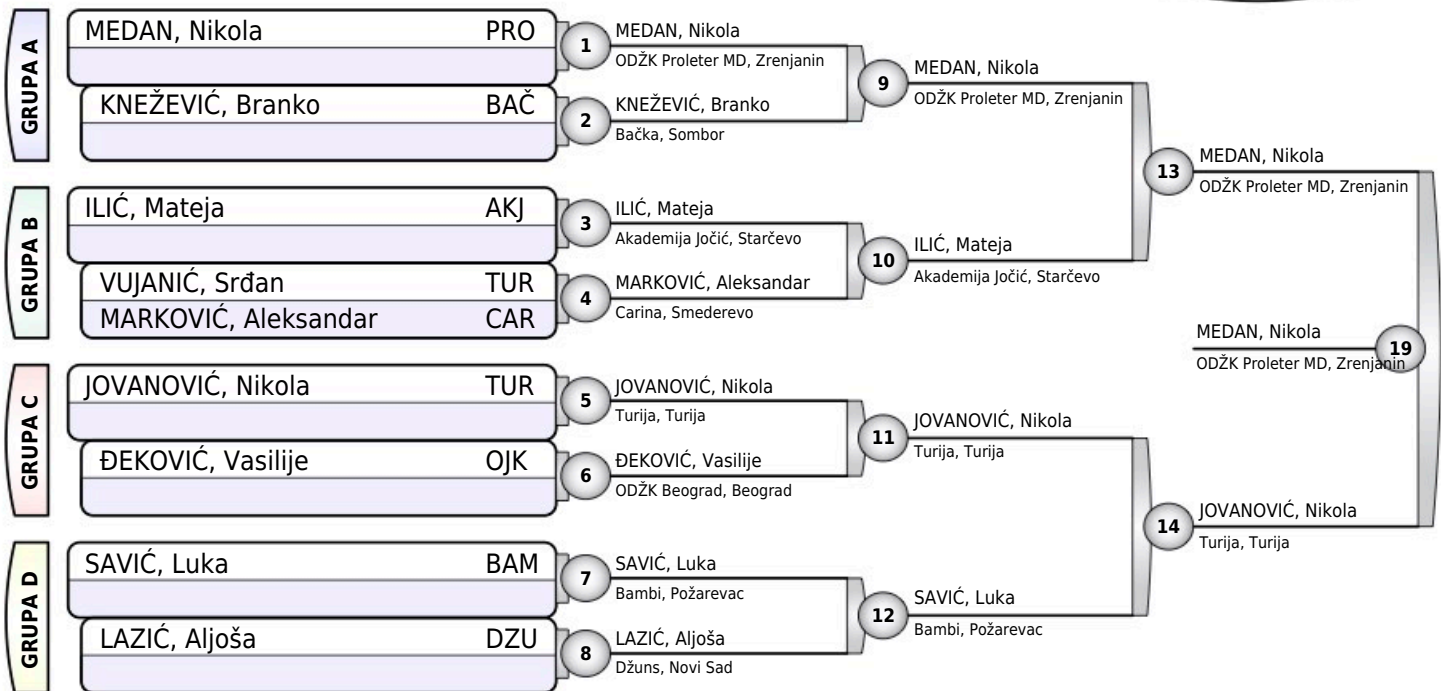

Rezultati

- MEDAN, Nikola PRO
- JOVANOVIĆ, Nikola TUR
- ILIĆ, Mateja AKJ
- ĐEKOVIĆ, Vasilije OJK
- KNEŽEVIĆ, Branko BAČ
- SAVIĆ, Luka BAM
-
-

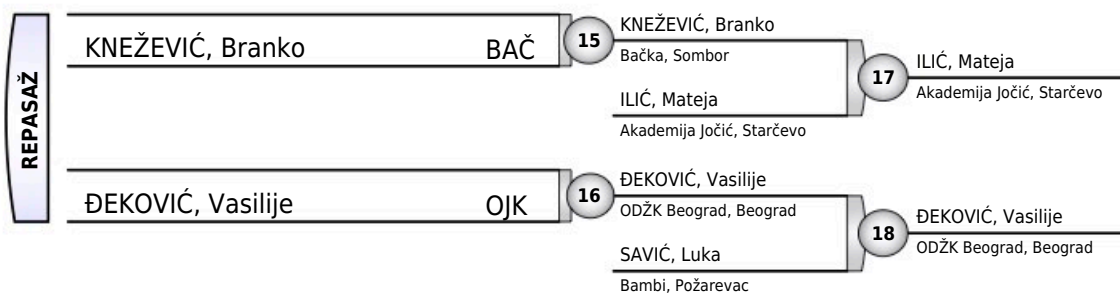



TROFEJ GRADA PANČEVA

Pančevo, 19.03.2022.

STARIJI DEČACI

-73KG

11 takmičara

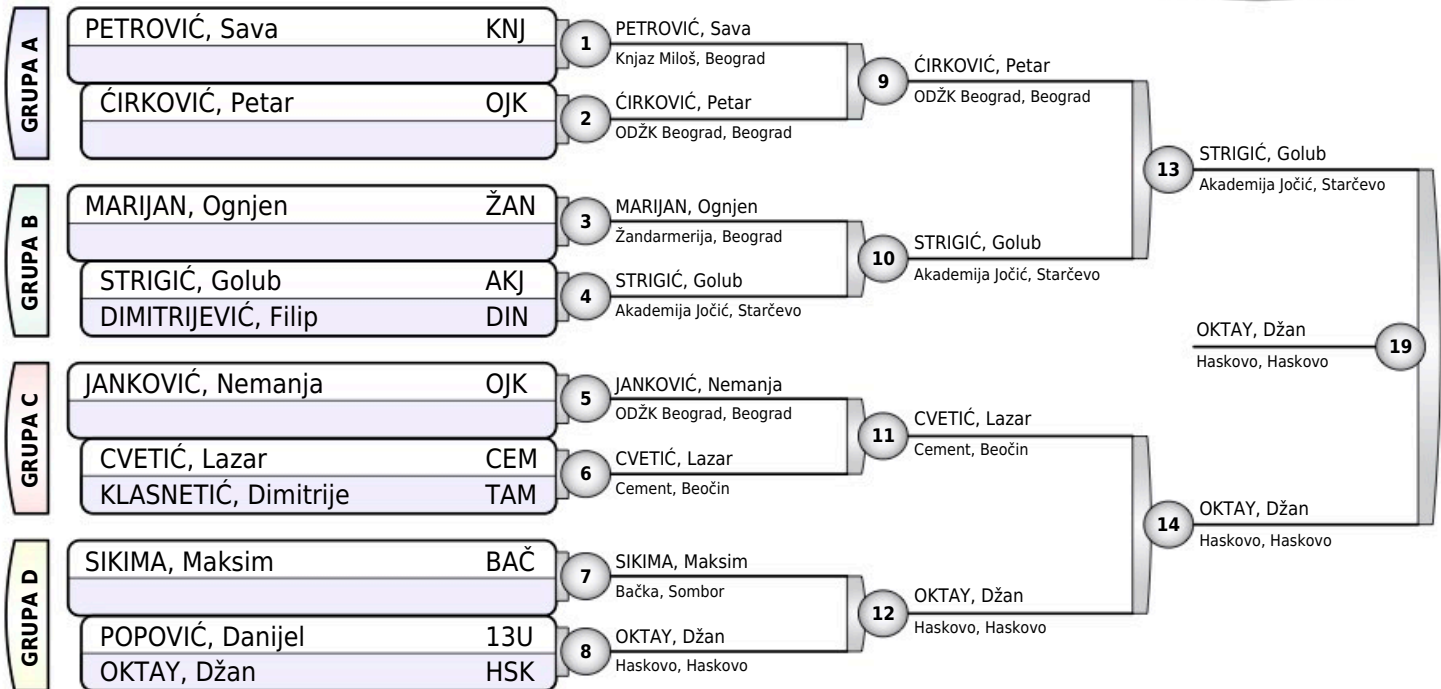

Rezultati

- | | | |
|----|---------------------|-----|
| 1. | OKTAY, Džan | HSK |
| 2. | STRIGIĆ, Golub | AKJ |
| 3. | ĆIRKOVIĆ, Petar | OJK |
| 3. | SIKIMA, Maksim | BAČ |
| 5. | MARIJAN, Ognjen | ŽAN |
| 5. | CVETIĆ, Lazar | CEM |
| 7. | DIMITRIJEVIĆ, Filip | DIN |
| 7. | POPOVIĆ, Danijel | 13U |

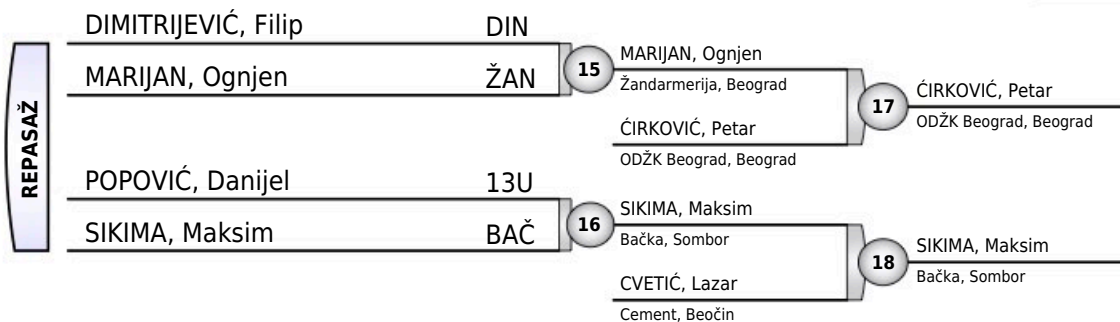



TROFEJ GRADA PANČEVA

Pančevo, 19.03.2022.

STARIJI DEČACI

+73KG

7 takmičara

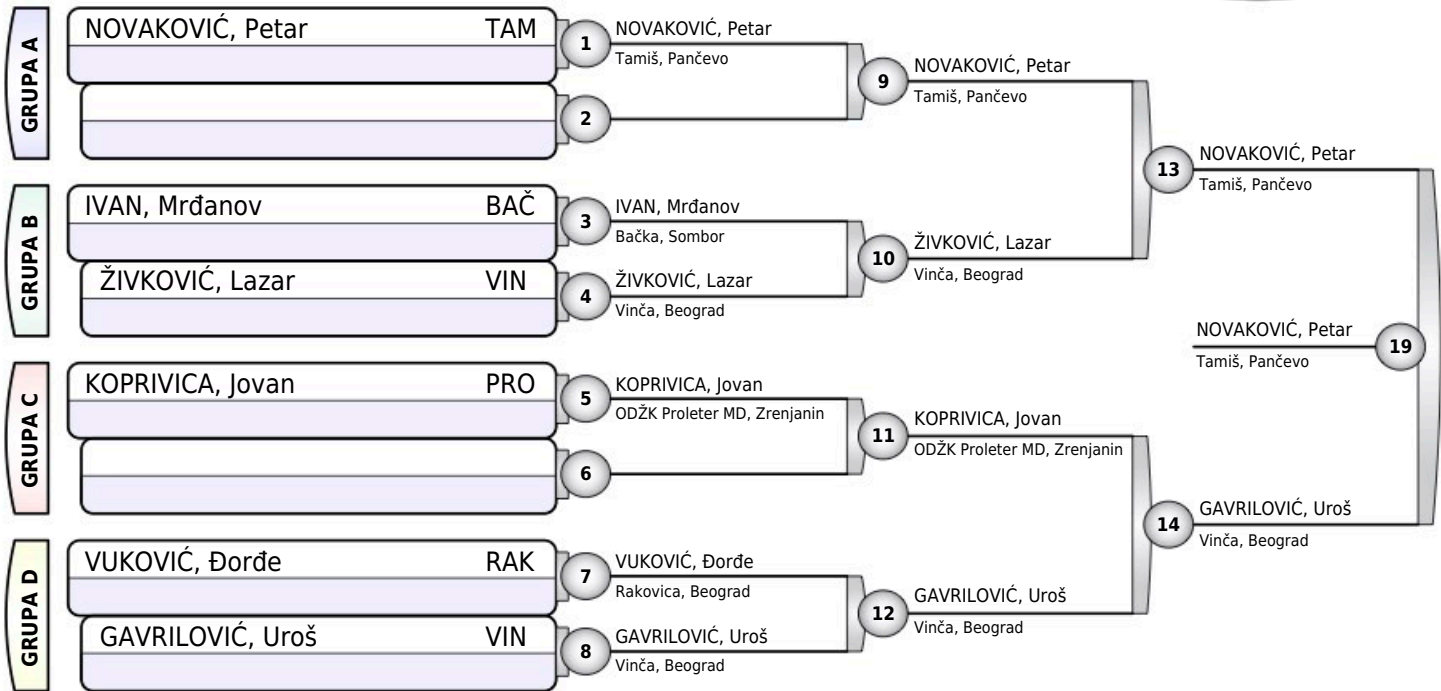

Rezultati

- NOVAKOVIĆ, Petar TAM
- GAVRILOVIĆ, Uroš VIN
- KOPRIVICA, Jovan PRO
- ŽIVKOVIĆ, Lazar VIN
- VUKOVIĆ, Đorđe RAK
-
-
-

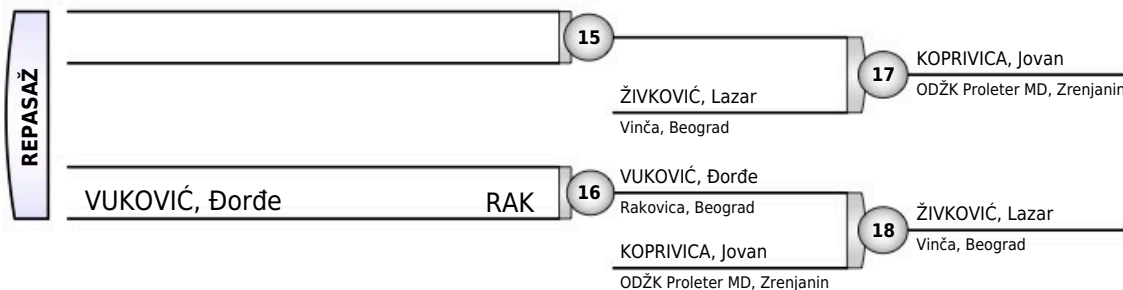



TROFEJ GRADA PANČEVA

Pančevo, 19.03.2022.

STARIJE DEVOJČICE

-36KG

3 takmičarke

TAKMIČAR I KLUB	1	2	3	POBEDA	BODOVA	MESTO
1 STANIMIROVIĆ, Adrijana Carina, Smederevo		0	0	0	0	3
2 VRČINAC, Milana Borac, Novi Sad	10		10	2	20	1
3 GORANOVIĆ, Katarina ODŽK Proleter MD, Zrenjanin	10	0		1	10	2

STANIMIROVIĆ, Adrijana	CAR	1	VRČINAC, Milana
VRČINAC, Milana	BNS		Borac, Novi Sad
STANIMIROVIĆ, Adrijana	CAR	2	GORANOVIĆ, Katarina
GORANOVIĆ, Katarina	PRO		ODŽK Proleter MD, Zrenjanin
VRČINAC, Milana	BNS	3	VRČINAC, Milana
GORANOVIĆ, Katarina	PRO		Borac, Novi Sad

Rezultati

1. VRČINAC, Milana BNS
2. GORANOVIĆ, Katarina PRO
3. STANIMIROVIĆ, Adrijana CAR



TROFEJ GRADA PANČEVA

Pančevo, 19.03.2022.

STARIJE DEVOJČICE

-40KG

5 takmičarki

TAKMIČAR I KLUB	1	2	3	4	5	POBEDA	BODOVA	MESTO
1 SAMARDŽIĆ, Saša Radnički, Beograd		0	10	10	0	2	20	3
2 SAVIĆ, Natalija ODŽK Beograd, Beograd	10		10	10	10	4	40	1
3 PAJIĆ, Maša Sportsko udruženje "Mija&Zorka", Subotica	0	0		10	0	1	10	3
4 LONČAR, Natalija Dinamo, Pančevo	0	0	0		0	0	0	5
5 MRĐA, Elena UDŽK Slavija, Novi Sad	10	0	10	10		3	30	2

SAMARDŽIĆ, Saša	RAD	1	SAVIĆ, Natalija
SAVIĆ, Natalija	OJK		ODŽK Beograd, Beograd
PAJIĆ, Maša	MIZ	2	PAJIĆ, Maša
LONČAR, Natalija	DIN		Sportsko udruženje "Mija&Zorka", Subotica
SAMARDŽIĆ, Saša	RAD	3	MRĐA, Elena
MRĐA, Elena	SLA		UDŽK Slavija, Novi Sad
SAVIĆ, Natalija	OJK	4	SAVIĆ, Natalija
PAJIĆ, Maša	MIZ		ODŽK Beograd, Beograd
LONČAR, Natalija	DIN	5	MRĐA, Elena
MRĐA, Elena	SLA		UDŽK Slavija, Novi Sad
SAMARDŽIĆ, Saša	RAD	6	SAMARDŽIĆ, Saša
PAJIĆ, Maša	MIZ		Radnički, Beograd
SAVIĆ, Natalija	OJK	7	SAVIĆ, Natalija
LONČAR, Natalija	DIN		ODŽK Beograd, Beograd
PAJIĆ, Maša	MIZ	8	MRĐA, Elena
MRĐA, Elena	SLA		UDŽK Slavija, Novi Sad
SAMARDŽIĆ, Saša	RAD	9	SAMARDŽIĆ, Saša
LONČAR, Natalija	DIN		Radnički, Beograd
SAVIĆ, Natalija	OJK	10	SAVIĆ, Natalija
MRĐA, Elena	SLA		ODŽK Beograd, Beograd

Rezultati

- | | |
|---------------------|-----|
| 1. SAVIĆ, Natalija | OJK |
| 2. MRĐA, Elena | SLA |
| 3. SAMARDŽIĆ, Saša | RAD |
| 3. PAJIĆ, Maša | MIZ |
| 5. LONČAR, Natalija | DIN |



TROFEJ GRADA PANČEVA

Pančevo, 19.03.2022.

STARIJE DEVOJČICE

-44KG

8 takmičarki

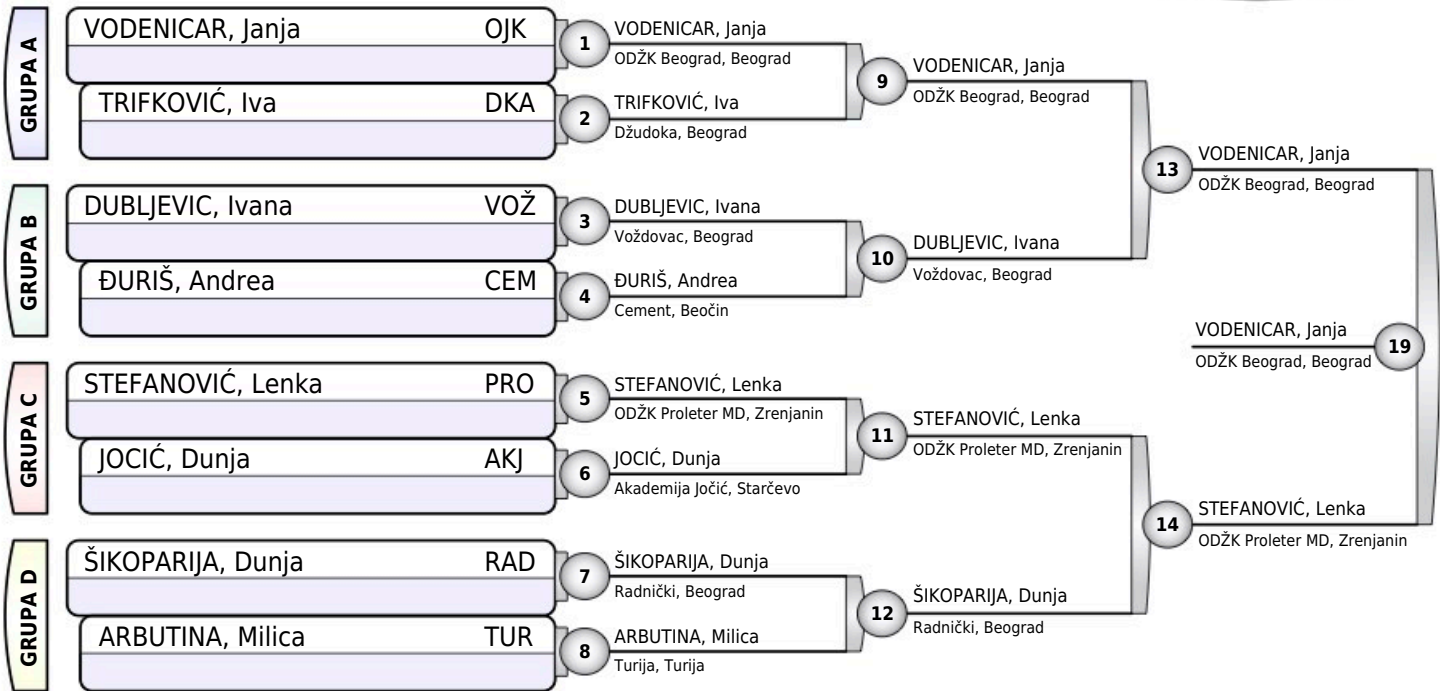

Rezultati

- VODENICAR, Janja OJK
- STEFANOVIĆ, Lenka PRO
- DUBLJEVIC, Ivana VOŽ
- ŠIKOPARIJA, Dunja RAD
- TRIFKOVIĆ, Iva DKA
- JOCIĆ, Dunja AKJ
-
-

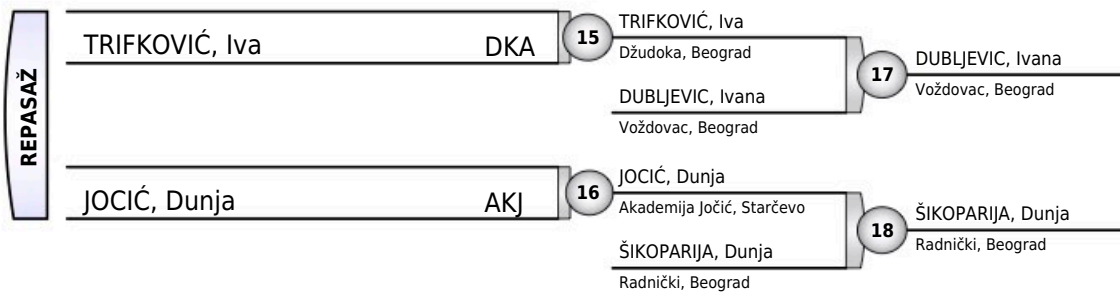



TROFEJ GRADA PANČEVA

Pančevo, 19.03.2022.

STARIJE DEVOJČICE

-48KG

5 takmičarki

TAKMIČAR I KLUB	1	2	3	4	5	POBEDA	BODOVA	MESTO
1 MITROVIĆ, Ena 13. maj, Ub	0	0	0	0	0	0	0	5
2 ŠTAJNFELD, Sara Sportsko udruženje "Mija&Zorka", Subotica	10	0	0	0	0	1	10	3
3 STOJANOV, Lenka ODŽK Proleter MD, Zrenjanin	10	1	0	10	1	4	22	1
4 TODOROVIĆ, Anđela ODŽK Beograd, Beograd	10	10	0	0	0	2	20	3
5 JOVANOVIĆ, Anja Žandarmerija, Beograd	10	10	0	10	0	3	30	2

MITROVIĆ, Ena	13U	1	ŠTAJNFELD, Sara
ŠTAJNFELD, Sara	MIZ		Sportsko udruženje "Mija&Zorka", Subotica
STOJANOV, Lenka	PRO	2	STOJANOV, Lenka
TODOROVIĆ, Anđela	OJK		ODŽK Proleter MD, Zrenjanin
MITROVIĆ, Ena	13U	3	JOVANOVIĆ, Anja
JOVANOVIĆ, Anja	ŽAN		Žandarmerija, Beograd
ŠTAJNFELD, Sara	MIZ	4	STOJANOV, Lenka
STOJANOV, Lenka	PRO		ODŽK Proleter MD, Zrenjanin
TODOROVIĆ, Anđela	OJK	5	JOVANOVIĆ, Anja
JOVANOVIĆ, Anja	ŽAN		Žandarmerija, Beograd
MITROVIĆ, Ena	13U	6	STOJANOV, Lenka
STOJANOV, Lenka	PRO		ODŽK Proleter MD, Zrenjanin
ŠTAJNFELD, Sara	MIZ	7	TODOROVIĆ, Anđela
TODOROVIĆ, Anđela	OJK		ODŽK Beograd, Beograd
STOJANOV, Lenka	PRO	8	STOJANOV, Lenka
JOVANOVIĆ, Anja	ŽAN		ODŽK Proleter MD, Zrenjanin
MITROVIĆ, Ena	13U	9	TODOROVIĆ, Anđela
TODOROVIĆ, Anđela	OJK		ODŽK Beograd, Beograd
ŠTAJNFELD, Sara	MIZ	10	JOVANOVIĆ, Anja
JOVANOVIĆ, Anja	ŽAN		Žandarmerija, Beograd

Rezultati

1. STOJANOV, Lenka PRO
2. JOVANOVIĆ, Anja ŽAN
3. TODOROVIĆ, Anđela OJK
3. ŠTAJNFELD, Sara MIZ
5. MITROVIĆ, Ena 13U



TROFEJ GRADA PANČEVA

Pančevo, 19.03.2022.

STARIJE DEVOJČICE

-52KG

10 takmičarki

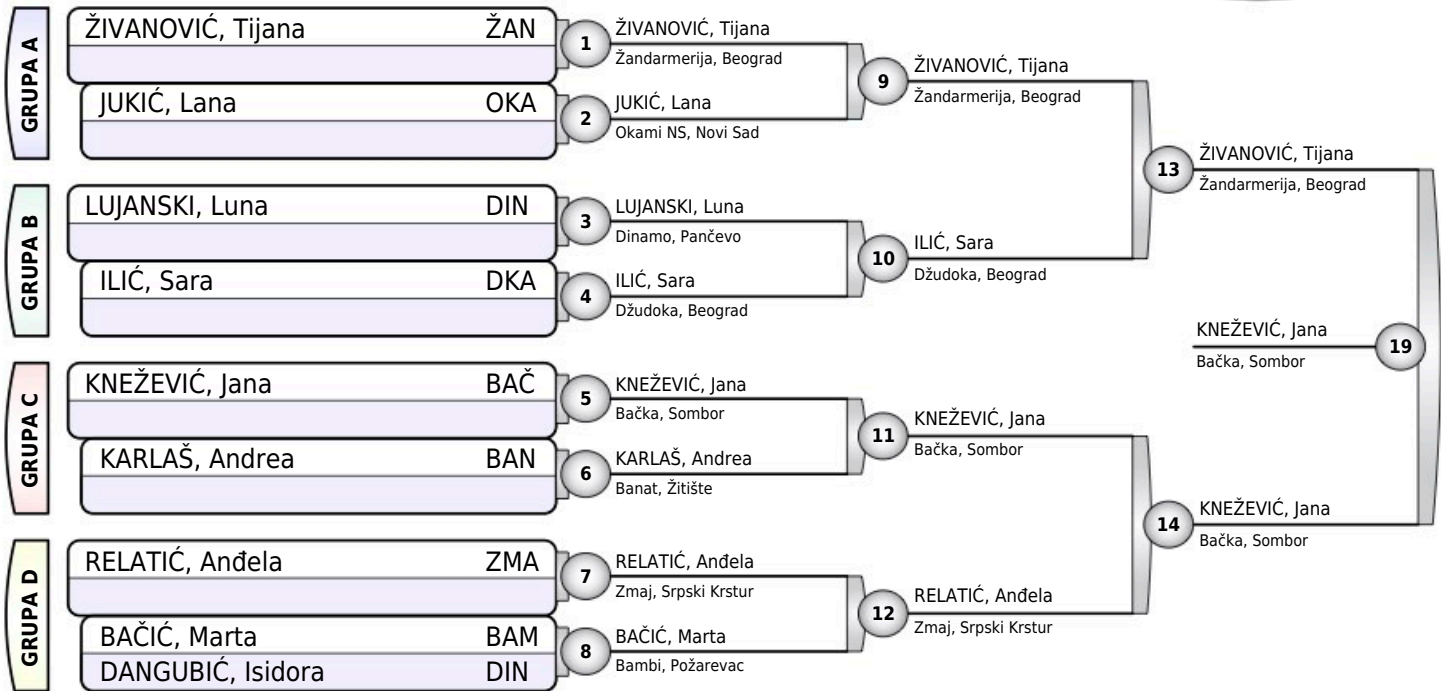

Rezultati

1. KNEŽEVIĆ, Jana BAČ
2. ŽIVANOVIĆ, Tijana ŽAN
3. JUKIĆ, Lana OKA
3. RELATIĆ, Anđela ZMA
5. ILIĆ, Sara DKA
5. KARLAŠ, Andrea BAN
- 7.
- 7.

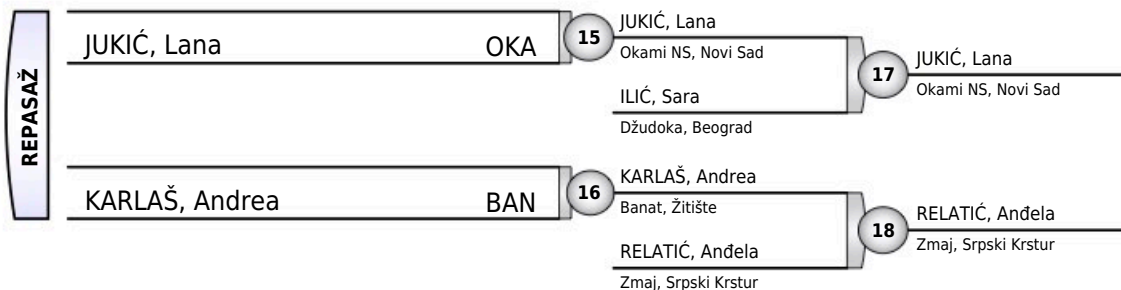



TROFEJ GRADA PANČEVA

Pančevo, 19.03.2022.

STARIJE DEVOJČICE

-57KG

2 takmičarke

MILJANOVIĆ, Miljana	CEM	1	BAHTJAREVIĆ, Ema Rakovica, Beograd
BAHTJAREVIĆ, Ema	RAK		
MILJANOVIĆ, Miljana	CEM	2	MILJANOVIĆ, Miljana Cement, Beočin
BAHTJAREVIĆ, Ema	RAK		
MILJANOVIĆ, Miljana	CEM	3	MILJANOVIĆ, Miljana Cement, Beočin
BAHTJAREVIĆ, Ema	RAK		

Rezultati

1. MILJANOVIĆ, Miljana CEM
2. BAHTJAREVIĆ, Ema RAK



TROFEJ GRADA PANČEVA

Pančevo, 19.03.2022.

STARIJE DEVOJČICE

-63KG

3 takmičarke

TAKMIČAR I KLUB	1	2	3	POBEDA	BODOVA	MESTO
1 TAXIDOU, Eleni Olimpiaki Elpida, Veria		10	10	2	20	1
2 STAJČIĆ, Nađa Tamiš, Pančevo	0		0	0	0	3
3 RADOJIČIĆ, Magdalena 13. maj, Ub	0	10		1	10	2

TAXIDOU, Eleni	OEV	1	TAXIDOU, Eleni
STAJČIĆ, Nađa	TAM		Olimpiaki Elpida, Veria
TAXIDOU, Eleni	OEV	2	TAXIDOU, Eleni
RADOJIČIĆ, Magdalena	13U		Olimpiaki Elpida, Veria
STAJČIĆ, Nađa	TAM	3	RADOJIČIĆ, Magdalena
RADOJIČIĆ, Magdalena	13U		13. maj, Ub

Rezultati

1. TAXIDOU, Eleni OEV
2. RADOJIČIĆ, Magdalena 13U
3. STAJČIĆ, Nađa TAM



TROFEJ GRADA PANČEVA

Pančevo, 19.03.2022.

STARIJE DEVOJČICE

+63KG

5 takmičarki

TAKMIČAR I KLUB	1	2	3	4	5	POBEDA	BODOVA	MESTO
1 PISARIĆ, Vanja Sportsko udruženje "Mija&Zorka", Subotica		0	10	10	0	2	20	3
2 RADAKOVIĆ, Milica ODŽK Proleter MD, Zrenjanin	10		10	10	0	3	30	2
3 VRANKOVIĆ, Milica Zmaj, Srpski Krstur	0	0		10	0	1	10	3
4 IVANOVIĆ, Anastasija Mladost Carina, Smederevo	0	0	0		0	0	0	5
5 STRIGIĆ, Natalija Akademija Jočić, Starčevo	10	10	10	10		4	40	1

PISARIĆ, Vanja	MIZ	1	RADAKOVIĆ, Milica
RADAKOVIĆ, Milica	PRO		ODŽK Proleter MD, Zrenjanin
VRANKOVIĆ, Milica	ZMA	2	VRANKOVIĆ, Milica
IVANOVIĆ, Anastasija	MLC		Zmaj, Srpski Krstur
PISARIĆ, Vanja	MIZ	3	STRIGIĆ, Natalija
STRIGIĆ, Natalija	AKJ		Akademija Jočić, Starčevo
RADAKOVIĆ, Milica	PRO	4	RADAKOVIĆ, Milica
VRANKOVIĆ, Milica	ZMA		ODŽK Proleter MD, Zrenjanin
IVANOVIĆ, Anastasija	MLC	5	STRIGIĆ, Natalija
STRIGIĆ, Natalija	AKJ		Akademija Jočić, Starčevo
PISARIĆ, Vanja	MIZ	6	PISARIĆ, Vanja
VRANKOVIĆ, Milica	ZMA		Sportsko udruženje "Mija&Zorka", Subotica
RADAKOVIĆ, Milica	PRO	7	RADAKOVIĆ, Milica
IVANOVIĆ, Anastasija	MLC		ODŽK Proleter MD, Zrenjanin
VRANKOVIĆ, Milica	ZMA	8	STRIGIĆ, Natalija
STRIGIĆ, Natalija	AKJ		Akademija Jočić, Starčevo
PISARIĆ, Vanja	MIZ	9	PISARIĆ, Vanja
IVANOVIĆ, Anastasija	MLC		Sportsko udruženje "Mija&Zorka", Subotica
RADAKOVIĆ, Milica	PRO	10	STRIGIĆ, Natalija
STRIGIĆ, Natalija	AKJ		Akademija Jočić, Starčevo

Rezultati

- STRIGIĆ, Natalija AKJ
- RADAKOVIĆ, Milica PRO
- PISARIĆ, Vanja MIZ
- VRANKOVIĆ, Milica ZMA
- IVANOVIĆ, Anastasija MLC