

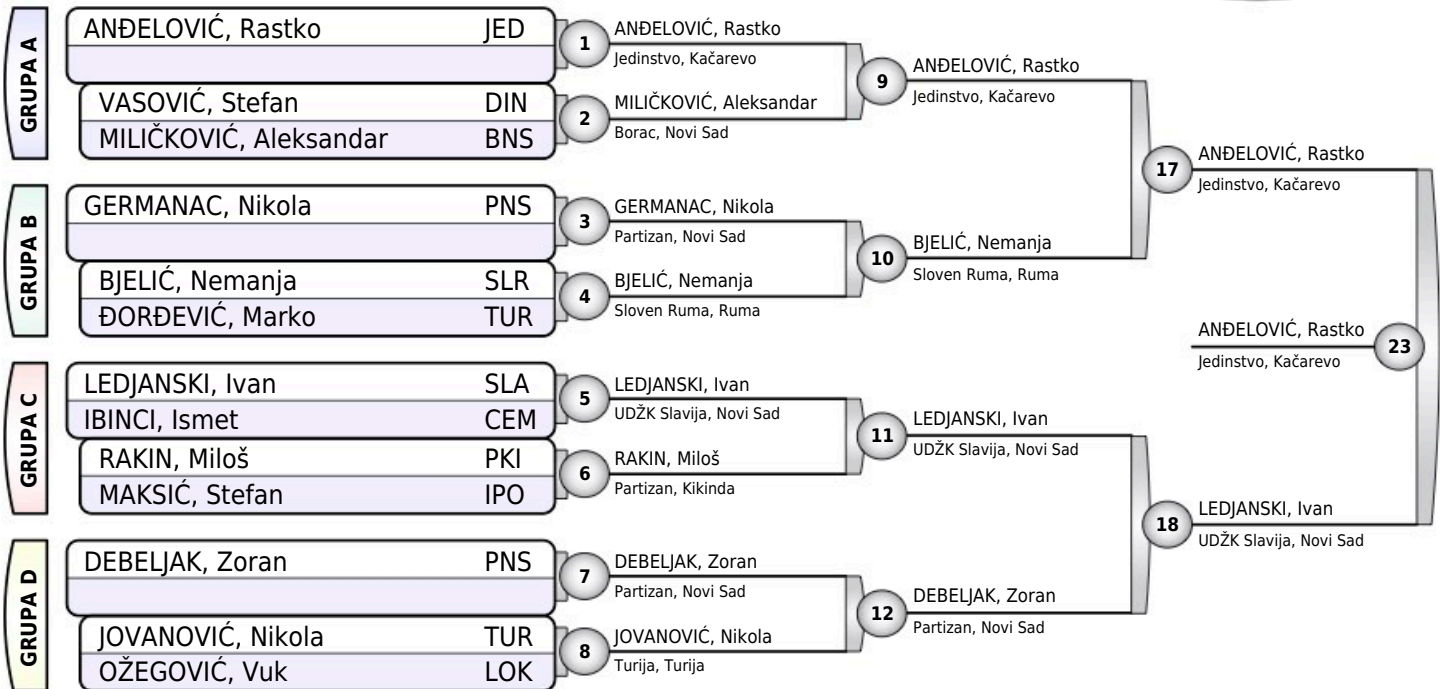

REGIONALNO VOJVODINA JUNIORI

Stepanovićevo, 09.04.2022.

JUNIORI
-60KG
14 takmičara



Rezultati

1. ANĐELOVIĆ, Rastko JED
2. LEDJANSKI, Ivan SLA
3. ĐORĐEVIĆ, Marko TUR
3. BJELIĆ, Nemanja SLR
- * 5. DEBELJAK, Zoran PNS
5. JOVANOVIĆ, Nikola TUR
7. MILIČKOVIĆ, Aleksandar BNS
7. RAKIN, Miloš PKI

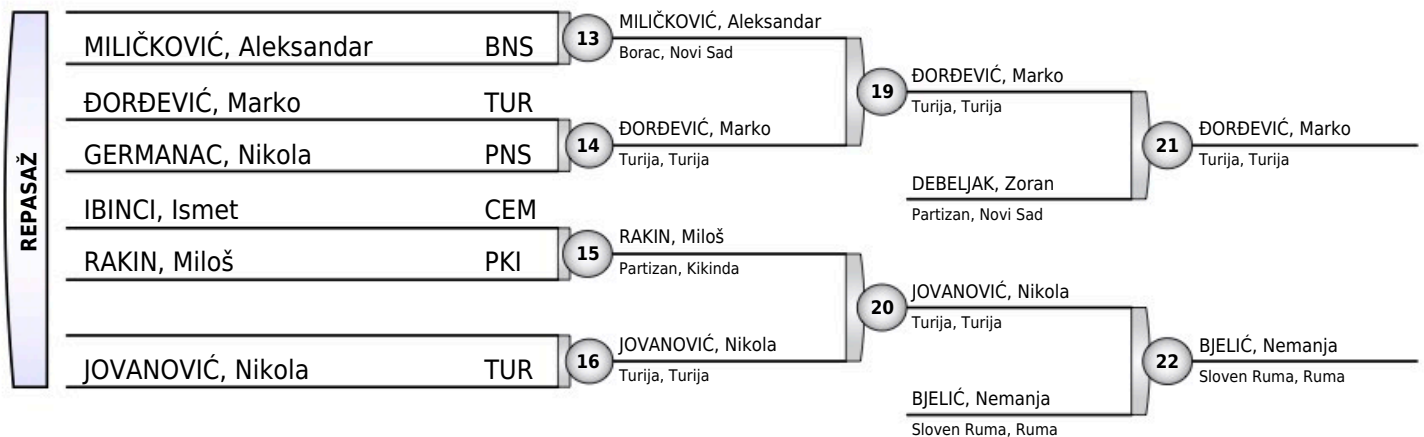



REGIONALNO VOJVODINA JUNIORI

Stepanovićevo, 09.04.2022.

JUNIORI
-66KG
15 takmičara

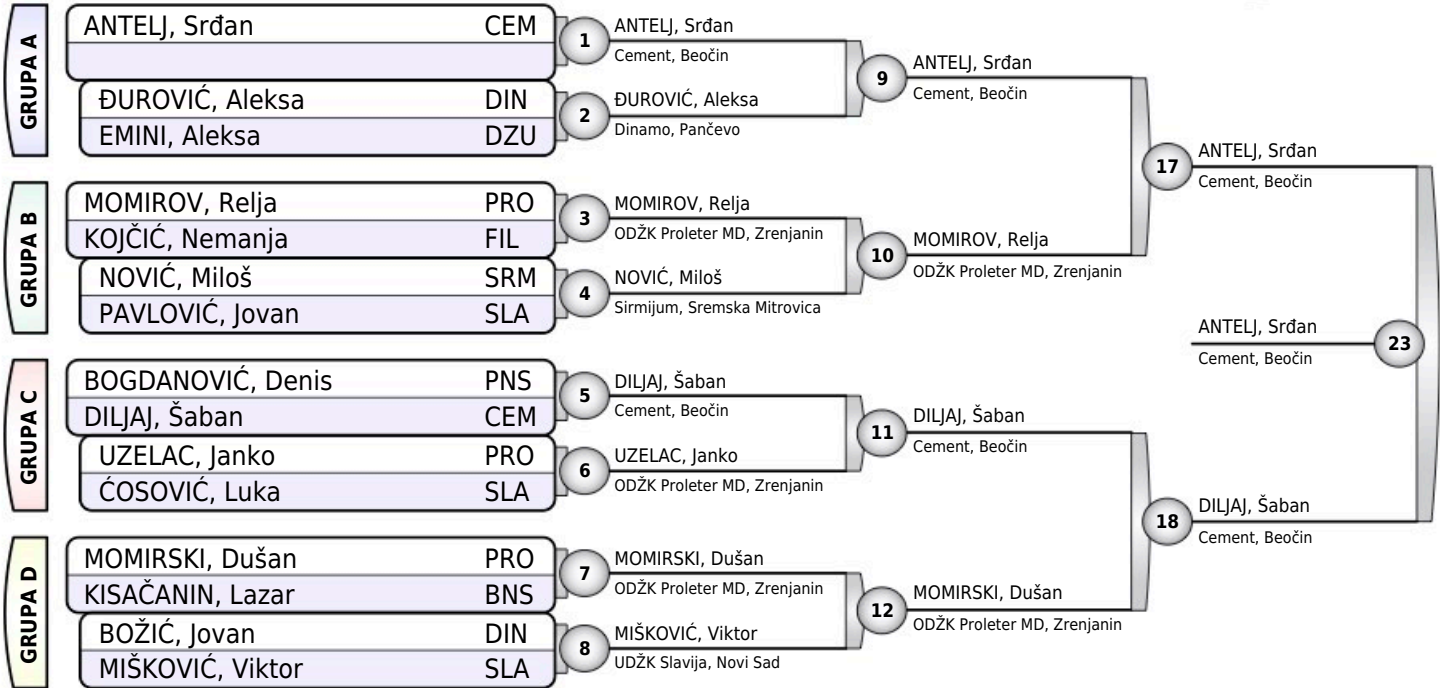

Rezultati

1. ANTELJ, Srđan CEM
2. DILJAJ, Šaban CEM
3. ĐUROVIĆ, Aleksa DIN
3. MOMIROV, Relja PRO
5. MOMIRSKI, Dušan PRO
5. BOGDANOVIĆ, Denis PNS
7. KOJČIĆ, Nemanja FIL
7. KISAČANIN, Lazar BNS

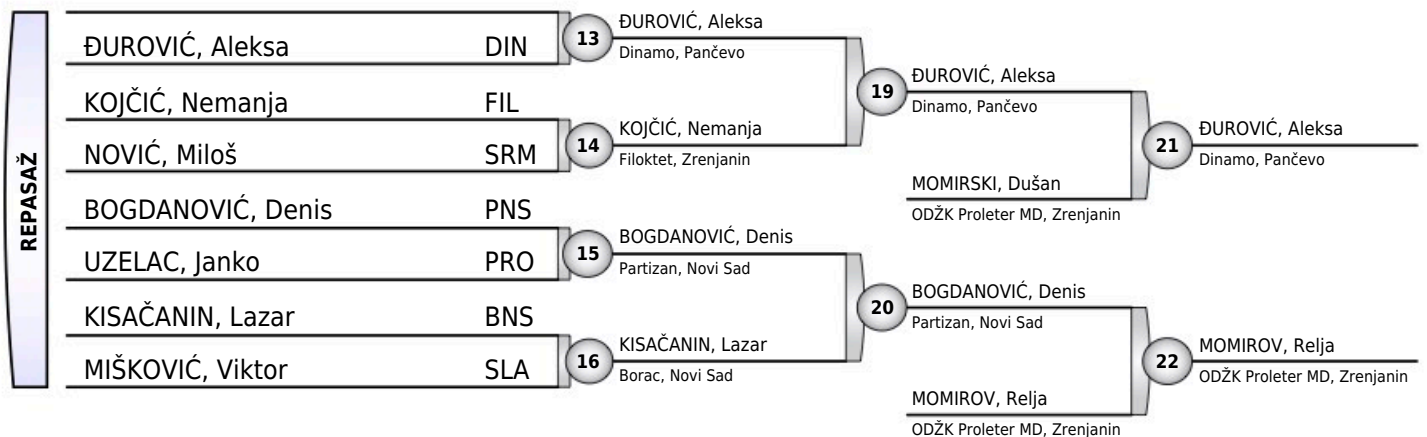



REGIONALNO VOJVODINA JUNIORI

Stepanovićevo, 09.04.2022.

JUNIORI
-73KG
15 takmičara

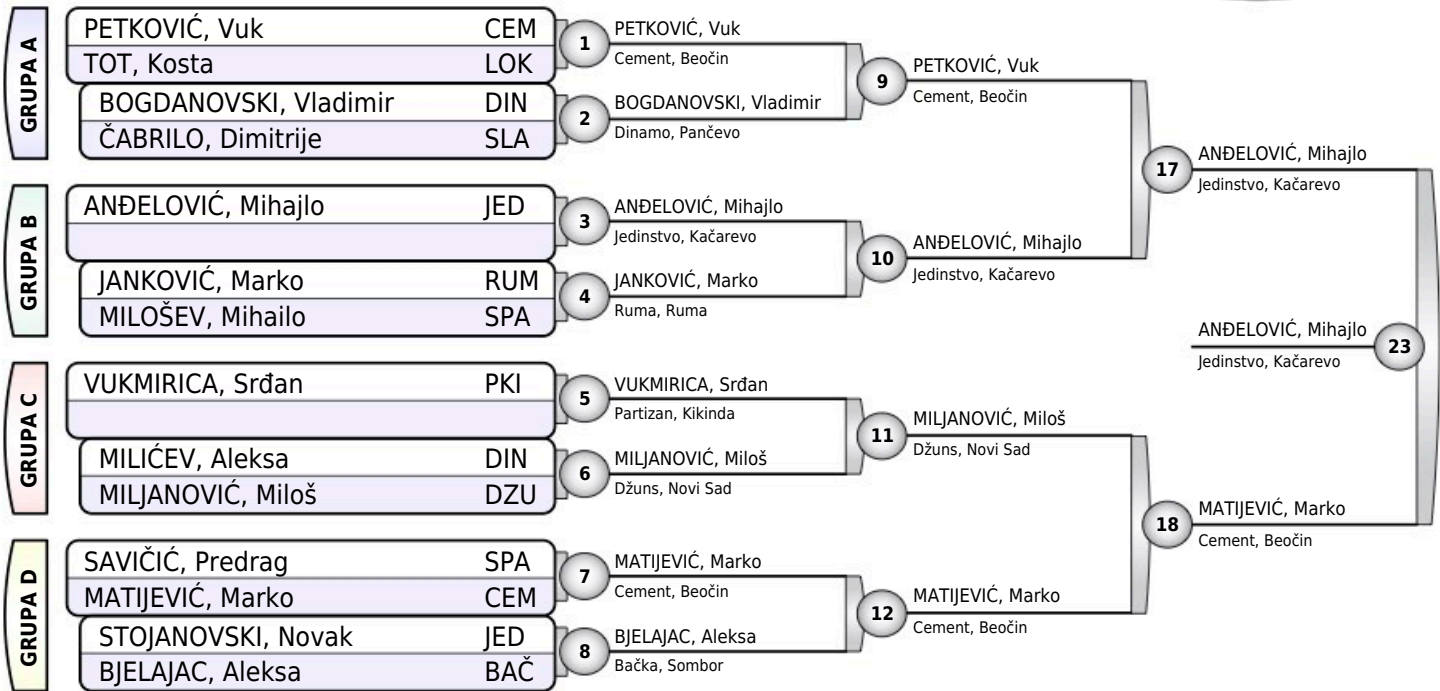

Rezultati

- ANĐELOVIĆ, Mihajlo JED
- MATIJEVIĆ, Marko CEM
- BOGDANOVSKI, Vladimir DIN
- SAVIČIĆ, Predrag SPA
- MILJANOVIĆ, Miloš DZU
- PETKOVIĆ, Vuk CEM
- JANKOVIĆ, Marko RUM
- * MILIĆEV, Aleksa DIN

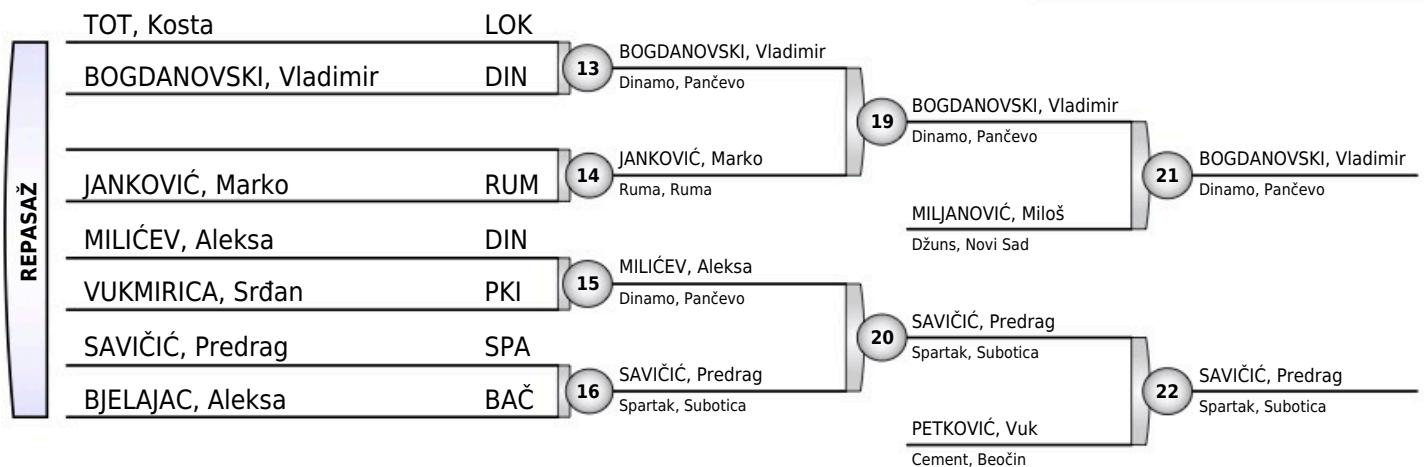



REGIONALNO VOJVODINA JUNIORI

Stepanovićevo, 09.04.2022.

JUNIORI
-81KG
13 takmičara

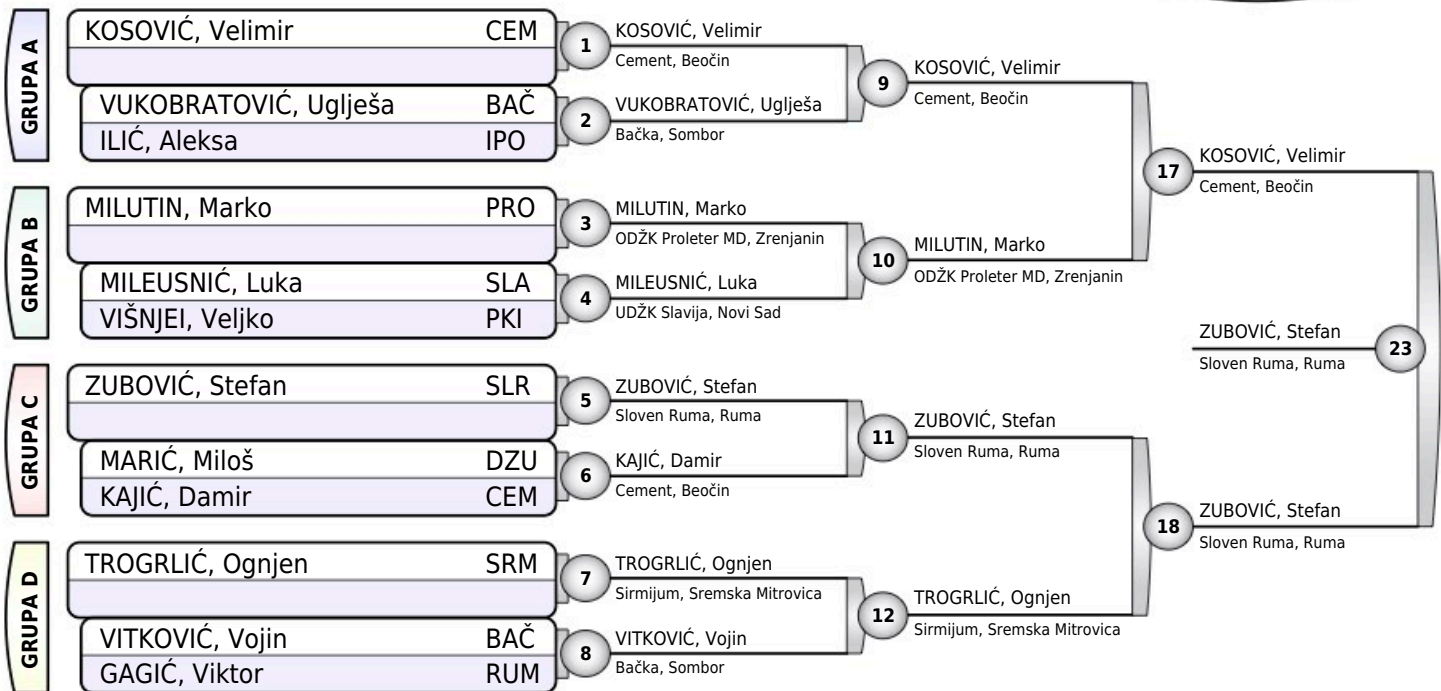

Rezultati

- ZUBOVIĆ, Stefan SLR
- KOSOVIĆ, Velimir CEM
- TROGRLIĆ, Ognjen SRM
- MILUTIN, Marko PRO
- MILEUSNIĆ, Luka SLA
- KAJIĆ, Damir CEM
- VUKOBRATOVIĆ, Uglješa BAČ
- VITKOVIĆ, Vojin BAČ

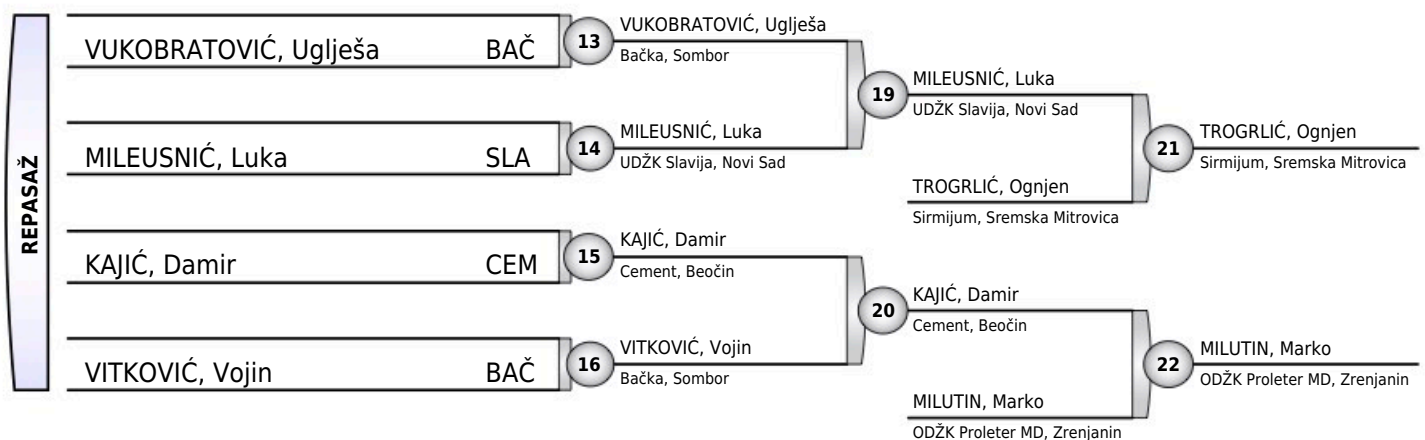



REGIONALNO VOJVODINA JUNIORI

Stepanovićevo, 09.04.2022.

JUNIORI
-90KG
11 takmičara

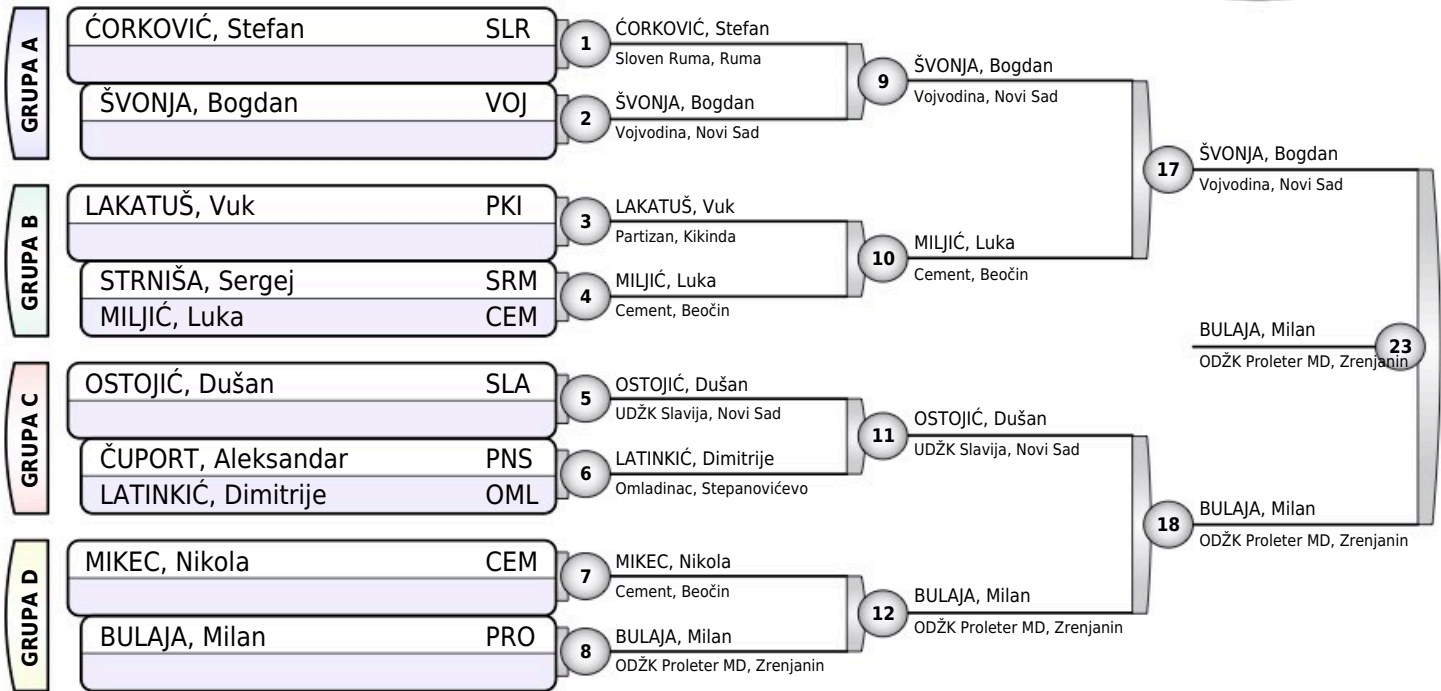

Rezultati

1. BULAJA, Milan PRO
2. ŠVONJA, Bogdan VOJ
3. OSTOJIĆ, Dušan SLA
3. MILJIĆ, Luka CEM
- * 5. LAKATUŠ, Vuk PKI
5. LATINKIĆ, Dimitrije OML
7. ĆORKOVIĆ, Stefan SLR
7. MIKEC, Nikola CEM

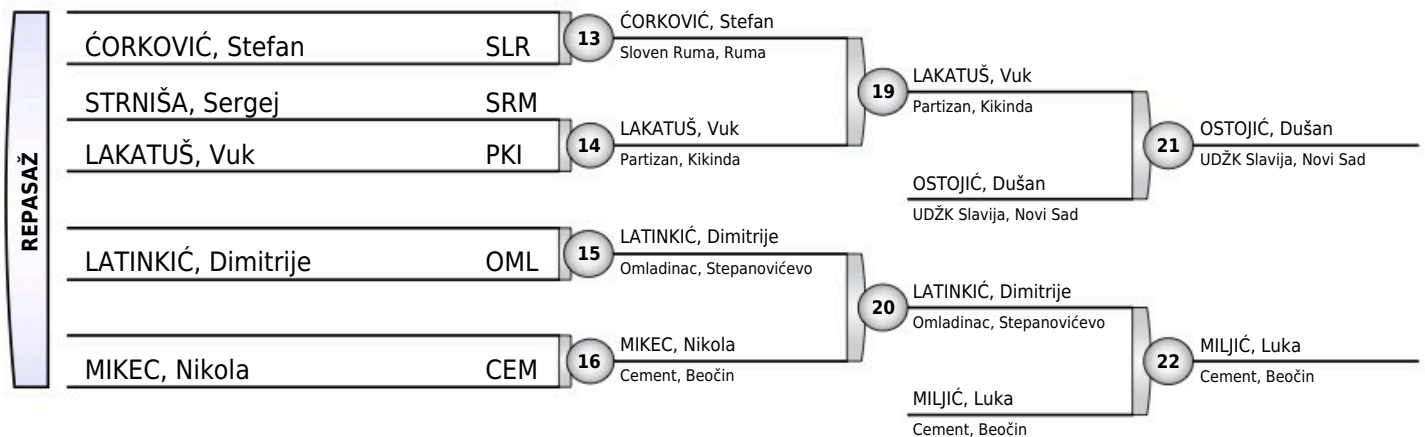



REGIONALNO VOJVODINA JUNIORI

Stepanovićevo, 09.04.2022.

JUNIORI

-100KG

7 takmičara

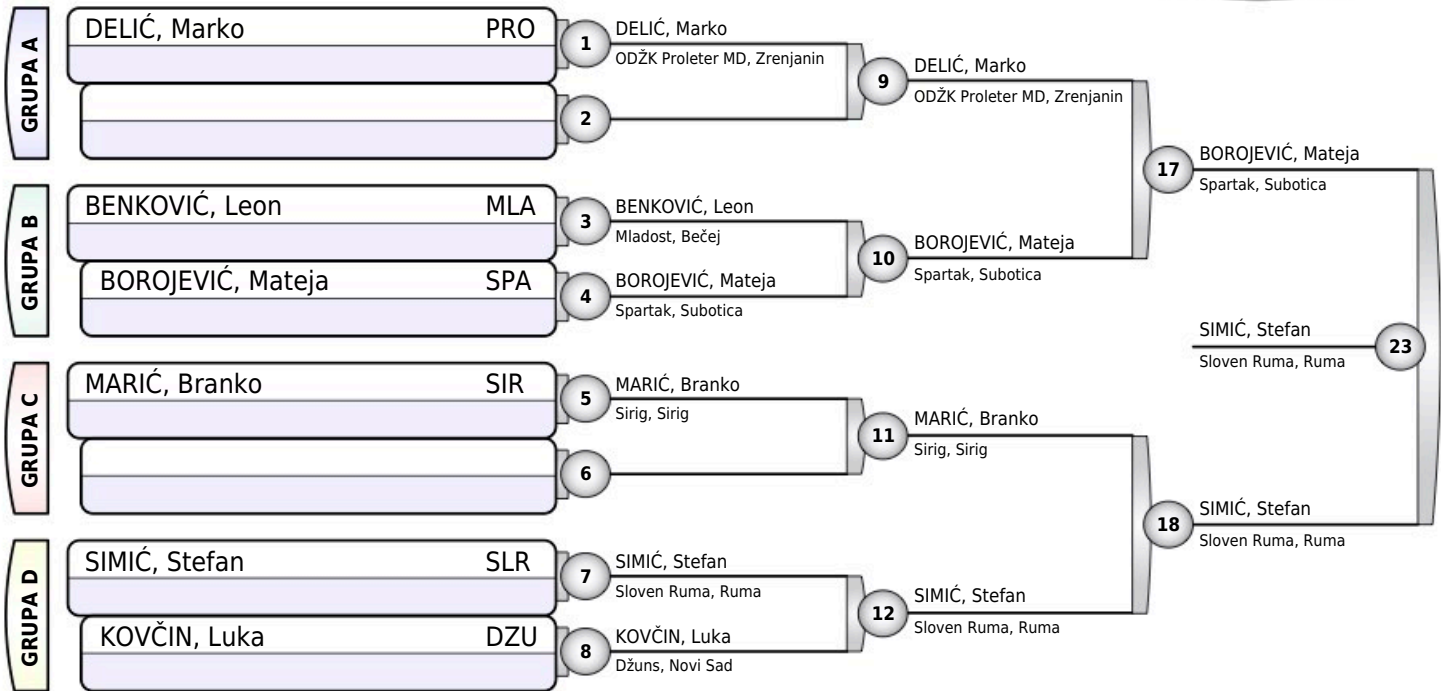

Rezultati

1. SIMIĆ, Stefan SLR
2. BOROJEVIĆ, Mateja SPA
3. MARIĆ, Branko SIR
3. KOVČIN, Luka DZU
5. BENKOVIĆ, Leon MLA
5. DELIĆ, Marko PRO
- 7.
- 7.

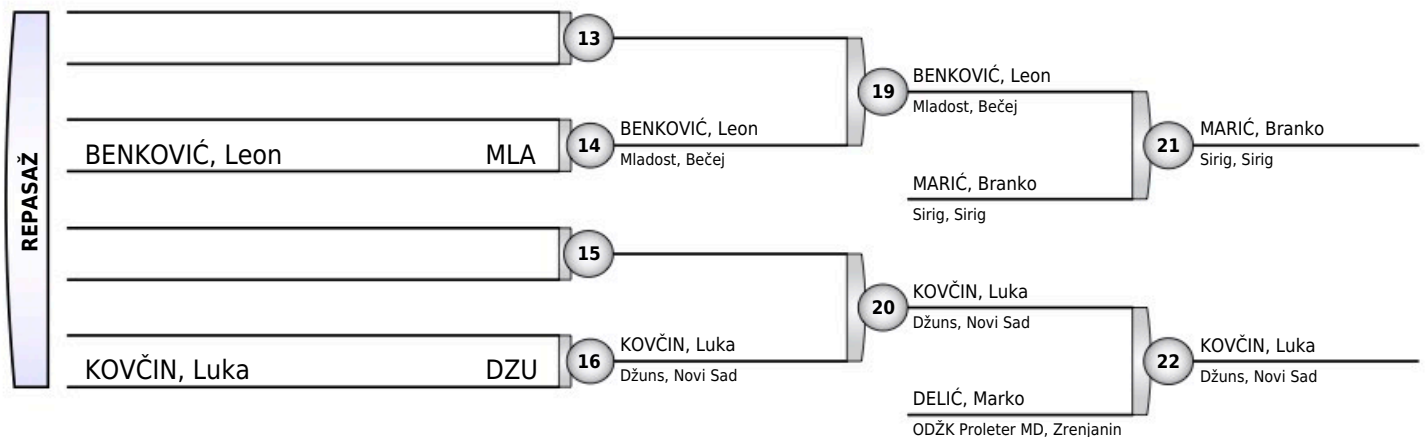



REGIONALNO VOJVODINA JUNIORI

Stepanovićevo, 09.04.2022.

JUNIORI
+100KG
7 takmičara

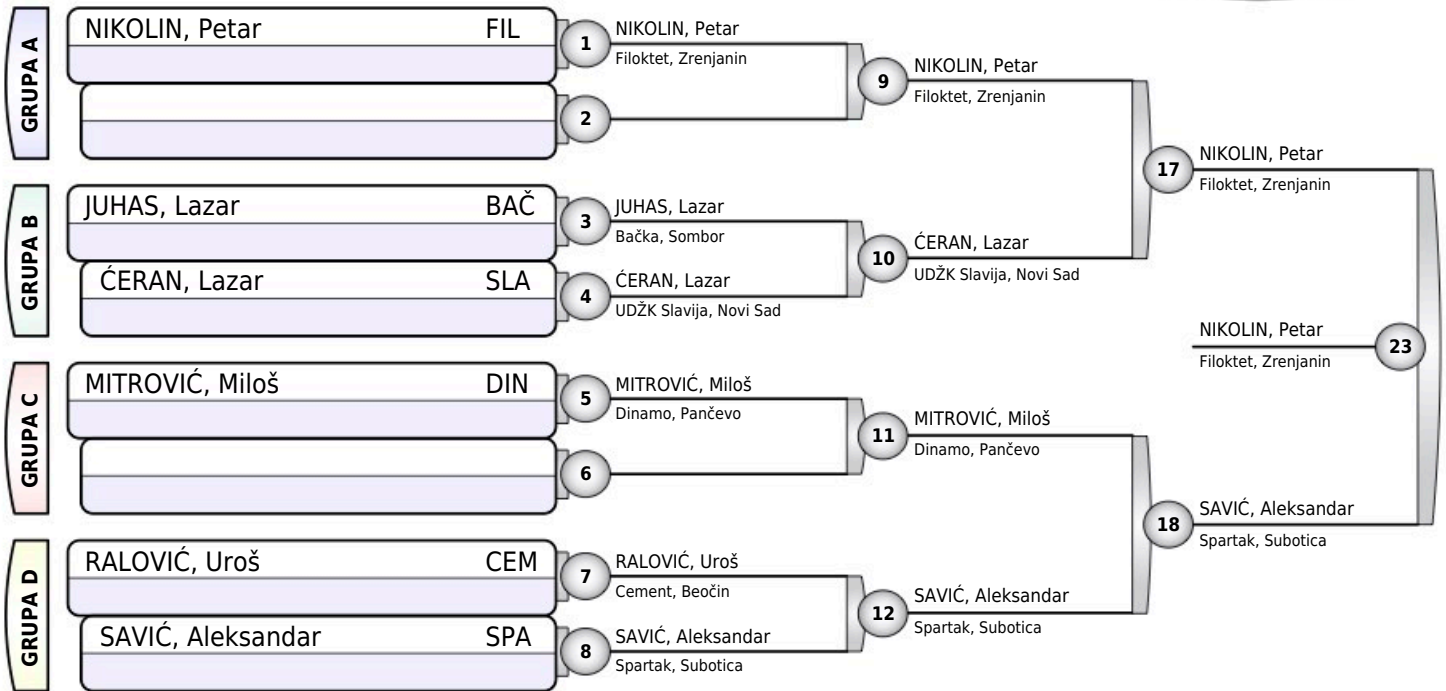

Rezultati

1. NIKOLIN, Petar (FIL)
2. SAVIĆ, Aleksandar (SPA)
3. JUHAS, Lazar (BAČ)
3. RALOVIĆ, Uroš (CEM)
5. MITROVIĆ, Miloš (DIN)
- * 5. ĆERAN, Lazar (SLA)
- 7.
- 7.

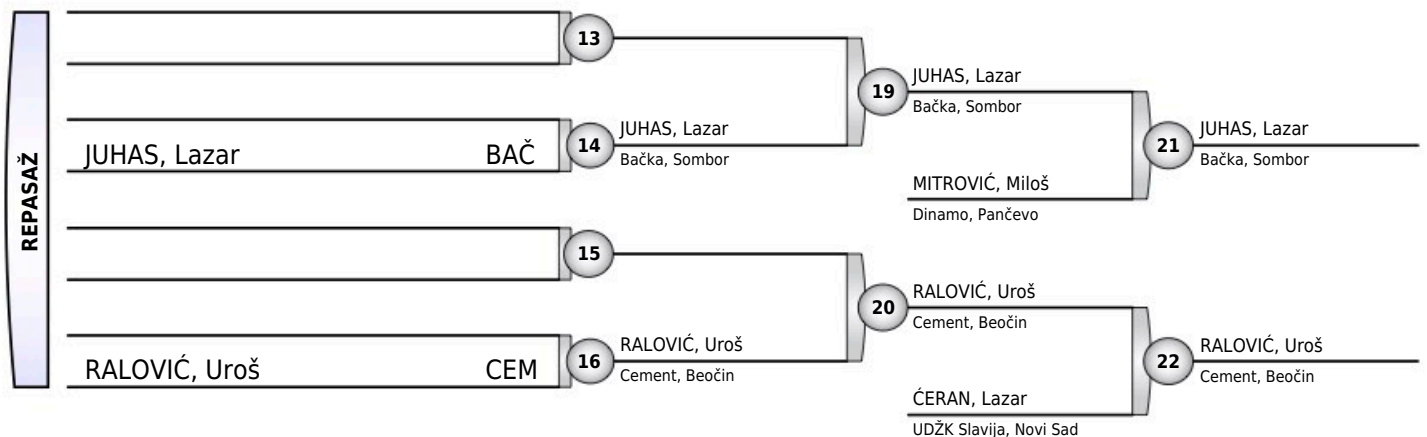



REGIONALNO VOJVODINA JUNIORI

Stepanovićevo, 09.04.2022.

JUNIORKE
-48KG
7 takmičarki

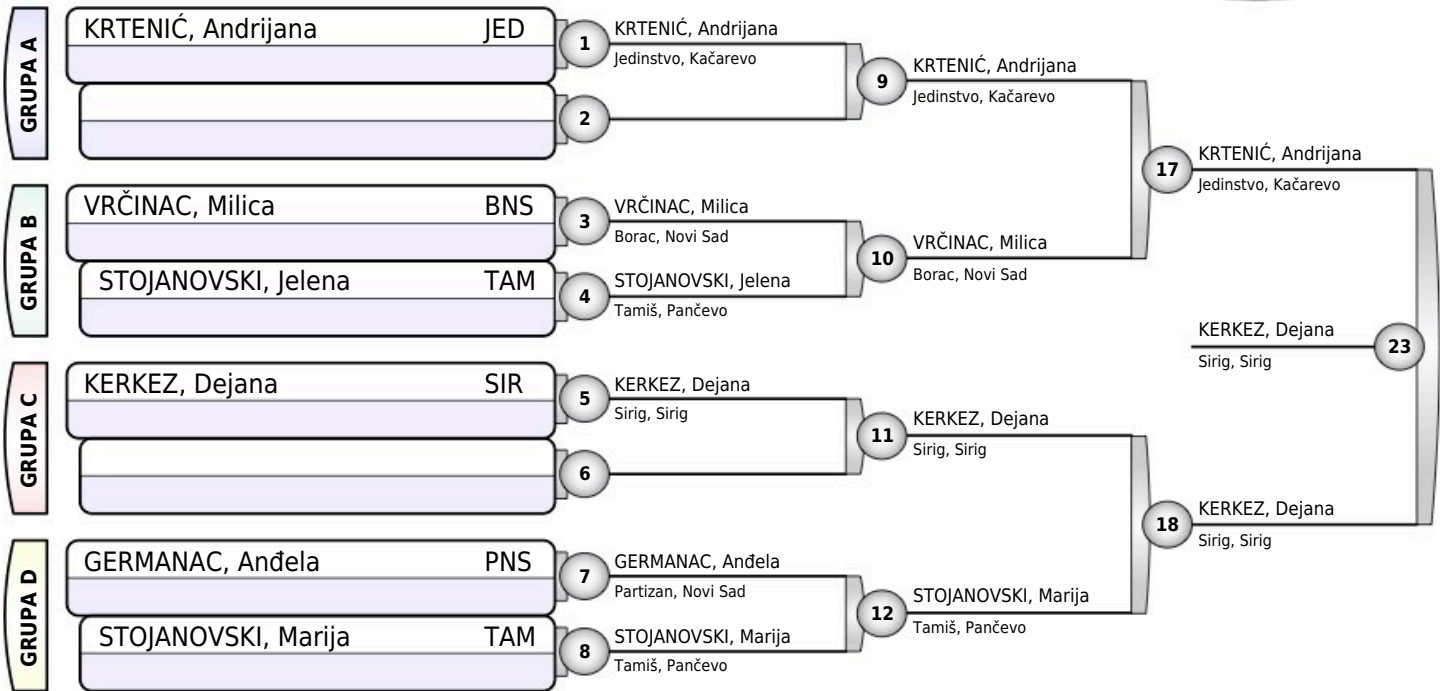

Rezultati

1. KERKEZ, Dejana SIR
2. KRTENIĆ, Andrijana JED
3. STOJANOVSKI, Marija TAM
3. GERMANAC, Anđela PNS
5. STOJANOVSKI, Jelena TAM
5. VRČINAC, Milica BNS
- 7.
- 7.

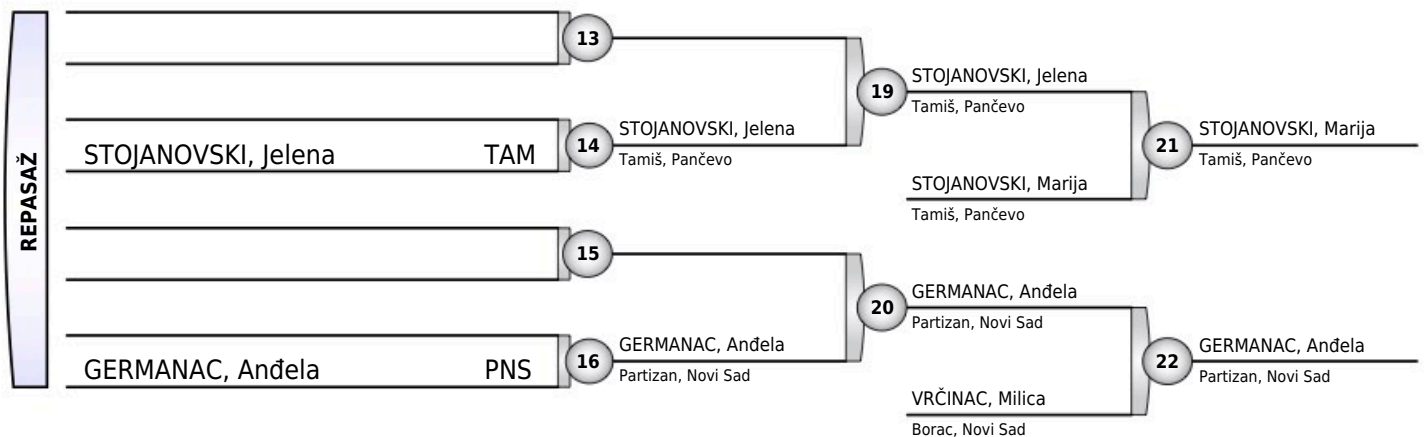



REGIONALNO VOJVODINA JUNIORI

Stepanovićevo, 09.04.2022.

JUNIORKE
-52KG
5 takmičarki

TAKMIČAR I KLUB	1	2	3	4	5	POBEDA	BODOVA	MESTO
1 MILJIĆ, Dunja Omladinac, Stepanovićevo	///	10	10	10	10	4	40	1
2 TANASKOVIĆ, Tamara Spartak, Subotica	0	///	10	0	10	2	20	2
3 OBADOV, Nina Partizan, Novi Sad	0	0	///	10	10	2	20	3
4 VRČINAC, Jovana Borac, Novi Sad	0	1	0	///	10	2	11	3
5 GRDAN, Aleksandra Tori, Vrbas	0	0	0	0	///	0	0	5

MILJIĆ, Dunja	OML	1	MILJIĆ, Dunja
TANASKOVIĆ, Tamara	SPA		Omladinac, Stepanovićevo
OBADOV, Nina	PNS	2	OBADOV, Nina
VRČINAC, Jovana	BNS		Partizan, Novi Sad
MILJIĆ, Dunja	OML	3	MILJIĆ, Dunja
GRDAN, Aleksandra	TOR		Omladinac, Stepanovićevo
TANASKOVIĆ, Tamara	SPA	4	TANASKOVIĆ, Tamara
OBADOV, Nina	PNS		Spartak, Subotica
VRČINAC, Jovana	BNS	5	VRČINAC, Jovana
GRDAN, Aleksandra	TOR		Borac, Novi Sad
MILJIĆ, Dunja	OML	6	MILJIĆ, Dunja
OBADOV, Nina	PNS		Omladinac, Stepanovićevo
TANASKOVIĆ, Tamara	SPA	7	VRČINAC, Jovana
VRČINAC, Jovana	BNS		Borac, Novi Sad
OBADOV, Nina	PNS	8	OBADOV, Nina
GRDAN, Aleksandra	TOR		Partizan, Novi Sad
MILJIĆ, Dunja	OML	9	MILJIĆ, Dunja
VRČINAC, Jovana	BNS		Omladinac, Stepanovićevo
TANASKOVIĆ, Tamara	SPA	10	TANASKOVIĆ, Tamara
GRDAN, Aleksandra	TOR		Spartak, Subotica

Rezultati

- | | |
|-----------------------|-----|
| 1. MILJIĆ, Dunja | OML |
| 2. TANASKOVIĆ, Tamara | SPA |
| 3. OBADOV, Nina | PNS |
| 3. VRČINAC, Jovana | BNS |
| 5. GRDAN, Aleksandra | TOR |



REGIONALNO VOJVODINA JUNIORI

Stepanovićevo, 09.04.2022.

JUNIORKE
-57KG
8 takmičarki

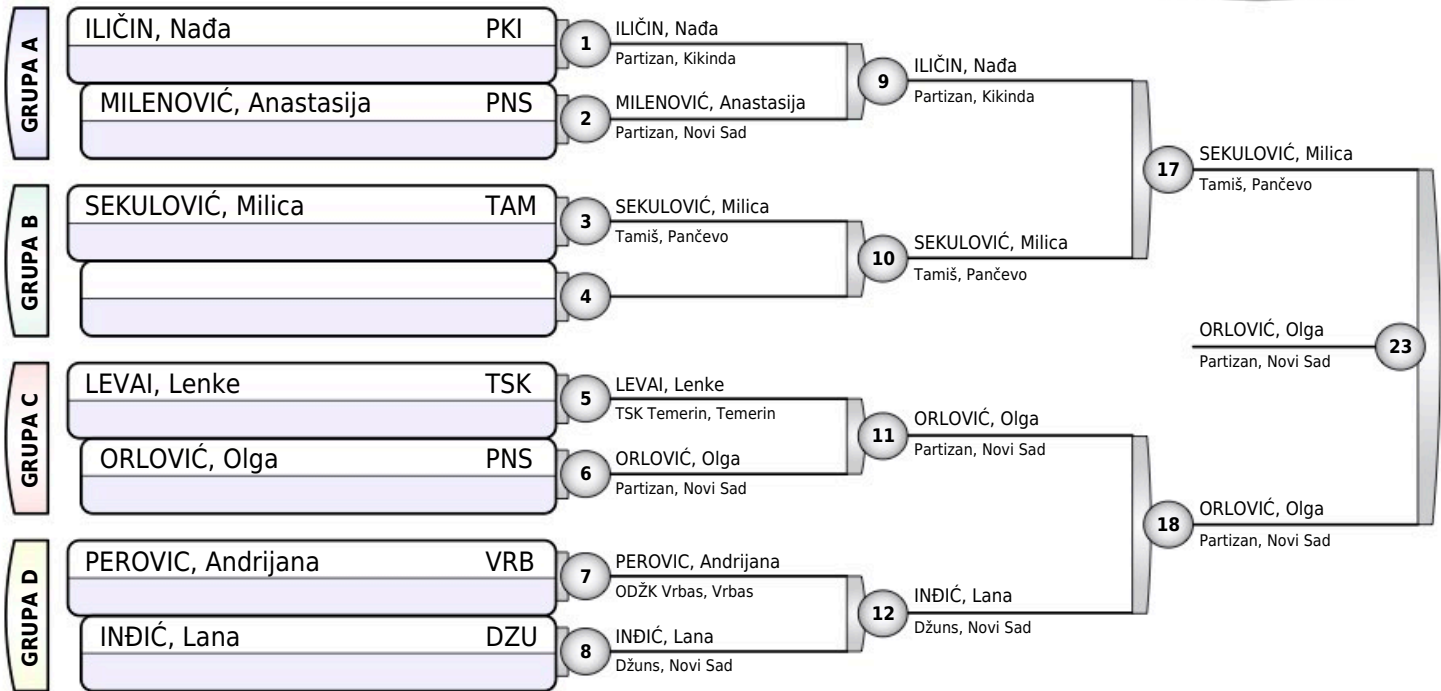

Rezultati

- ORLOVIĆ, Olga (PNS)
- SEKULOVIĆ, Milica (TAM)
- MILENOVIĆ, Anastasija (PNS)
- ILIČIN, Nađa (PKI)
- INĐIĆ, Lana (DZU)
- PEROVIC, Andrijana (VRB)
- LEVAI, Lenke (TSK)
-

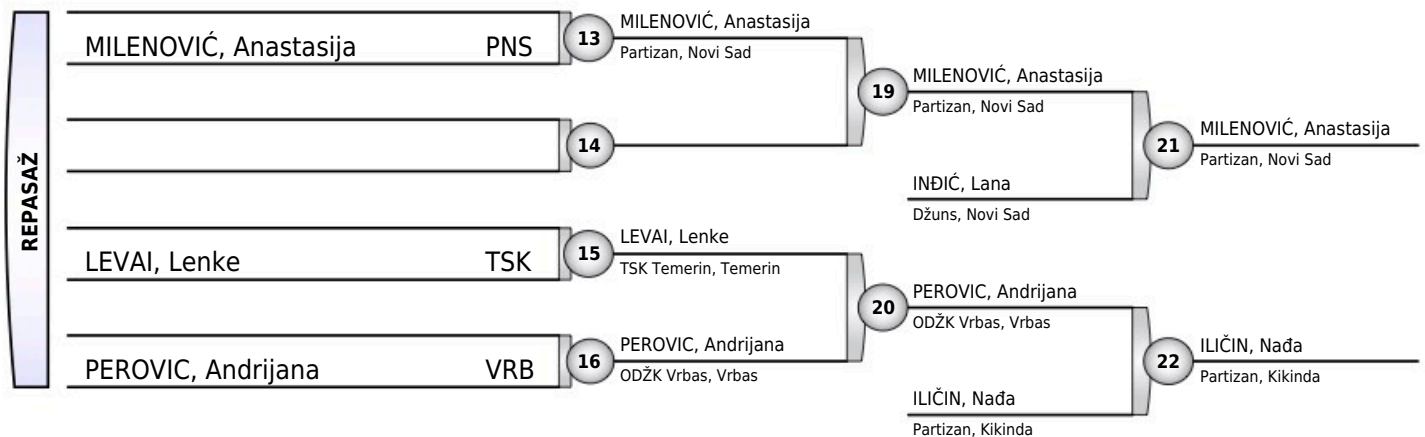



REGIONALNO VOJVODINA JUNIORI

Stepanovićevo, 09.04.2022.

JUNIORKE
-63KG
5 takmičarki

TAKMIČAR I KLUB	1	2	3	4	5	POBEDA	BODOVA	MESTO
1 MLADENOVIĆ, Dunja ODŽK Proleter MD, Zrenjanin		10	10	10	10	4	40	1
2 NAĐ, Katarina Omladinac, Stepanovićevo	0		10	10	10	3	30	2
3 ĐEKIĆ, Tara Lokomotiva, Vršac	0	0		1	10	2	11	3
4 GADŽIĆ, Nataša Turija, Turija	0	0	0		10	1	10	3
5 MILANOVIĆ, Marjana Dinamo, Pančevo	0	0	0	0		0	0	5

MLADENOVIĆ, Dunja	PRO	1	MLADENOVIĆ, Dunja
NAĐ, Katarina	OML		ODŽK Proleter MD, Zrenjanin
ĐEKIĆ, Tara	LOK	2	ĐEKIĆ, Tara
GADŽIĆ, Nataša	TUR		Lokomotiva, Vršac
MLADENOVIĆ, Dunja	PRO	3	MLADENOVIĆ, Dunja
MILANOVIĆ, Marjana	DIN		ODŽK Proleter MD, Zrenjanin
NAĐ, Katarina	OML	4	NAĐ, Katarina
ĐEKIĆ, Tara	LOK		Omladinac, Stepanovićevo
GADŽIĆ, Nataša	TUR	5	GADŽIĆ, Nataša
MILANOVIĆ, Marjana	DIN		Turija, Turija
MLADENOVIĆ, Dunja	PRO	6	MLADENOVIĆ, Dunja
ĐEKIĆ, Tara	LOK		ODŽK Proleter MD, Zrenjanin
NAĐ, Katarina	OML	7	NAĐ, Katarina
GADŽIĆ, Nataša	TUR		Omladinac, Stepanovićevo
ĐEKIĆ, Tara	LOK	8	ĐEKIĆ, Tara
MILANOVIĆ, Marjana	DIN		Lokomotiva, Vršac
MLADENOVIĆ, Dunja	PRO	9	MLADENOVIĆ, Dunja
GADŽIĆ, Nataša	TUR		ODŽK Proleter MD, Zrenjanin
NAĐ, Katarina	OML	10	NAĐ, Katarina
MILANOVIĆ, Marjana	DIN		Omladinac, Stepanovićevo

Rezultati

1. MLADENOVIĆ, Dunja PRO
2. NAĐ, Katarina OML
3. ĐEKIĆ, Tara LOK
3. GADŽIĆ, Nataša TUR
5. MILANOVIĆ, Marjana DIN



REGIONALNO VOJVODINA JUNIORI

Stepanovićevo, 09.04.2022.

JUNIORKE
-70KG
10 takmičarki

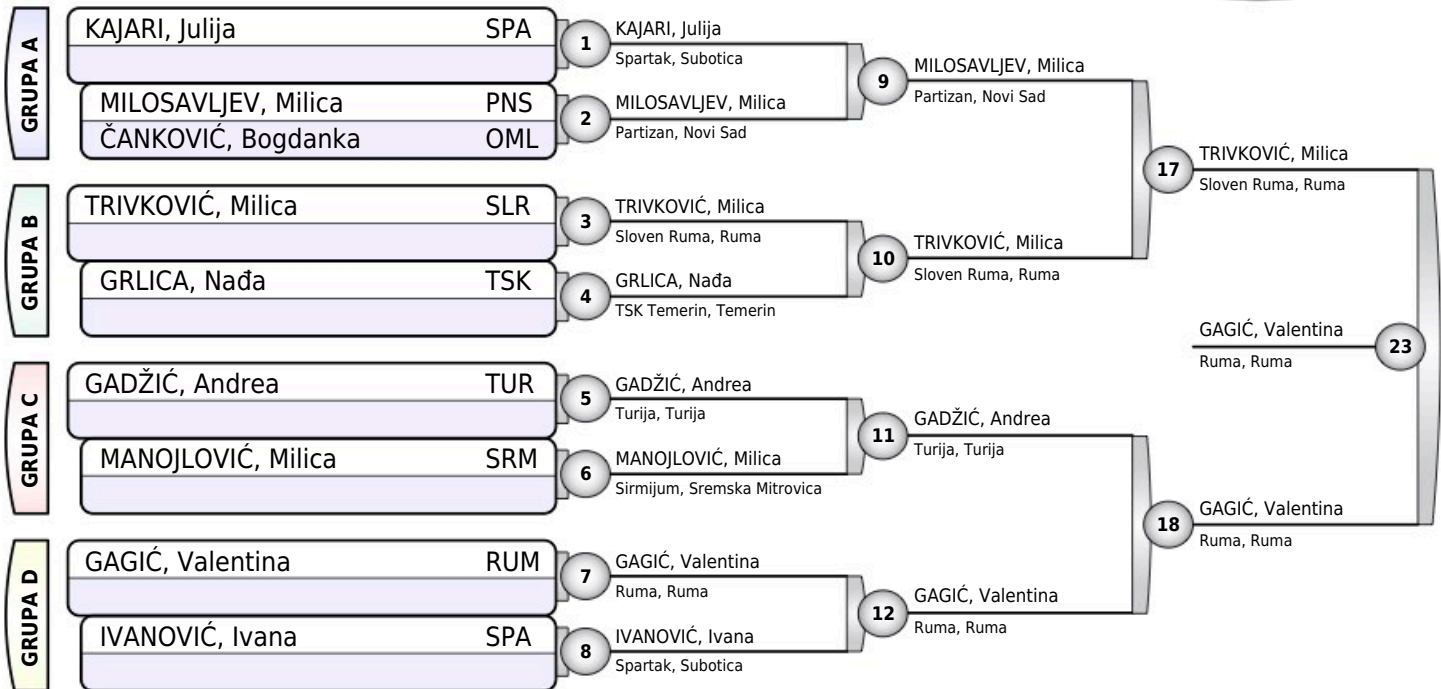

Rezultati

1. GAGIĆ, Valentina RUM
2. TRIVKOVIĆ, Milica SLR
3. GADŽIĆ, Andrea TUR
3. MANOJLOVIĆ, Milica SRM
- * 5. GRLICA, Nađa TSK
5. MILOSAVLJEV, Milica PNS
7. ČANKOVIĆ, Bogdanka OML
7. IVANOVIĆ, Ivana SPA

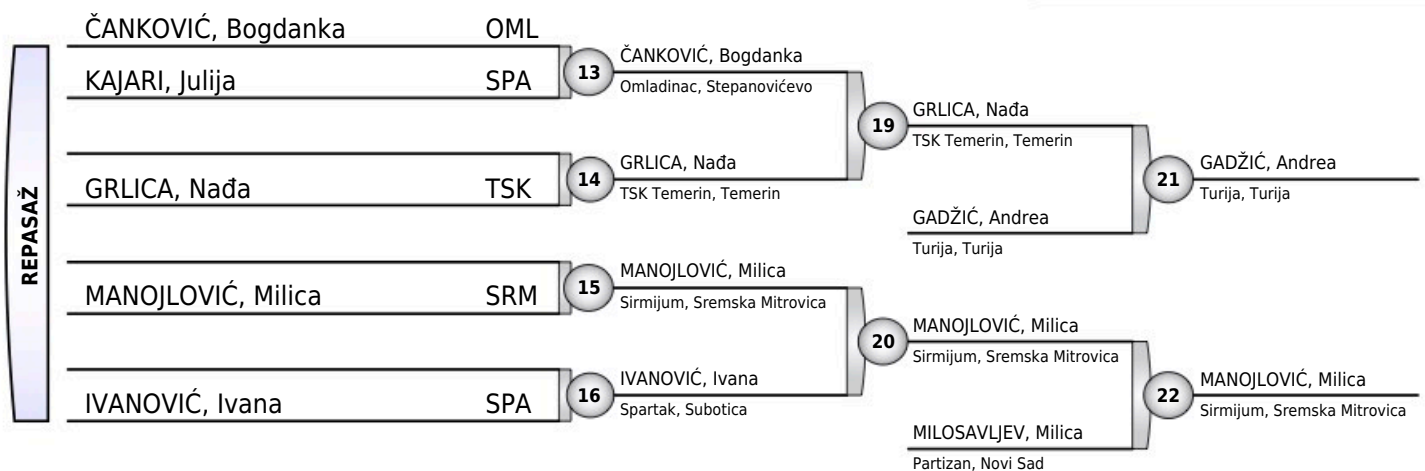



REGIONALNO VOJVODINA JUNIORI

Stepanovićevo, 09.04.2022.

JUNIORKE
-78KG
2 takmičarke

TEKIĆ, Nađa	TSK	1	TEKIĆ, Nađa
MARTON, Anja	LOK		TSK Temerin, Temerin
TEKIĆ, Nađa	TSK	2	MARTON, Anja
MARTON, Anja	LOK		Lokomotiva, Vršac
TEKIĆ, Nađa	TSK	3	TEKIĆ, Nađa
MARTON, Anja	LOK		TSK Temerin, Temerin

Rezultati

1. TEKIĆ, Nađa TSK
2. MARTON, Anja LOK



REGIONALNO VOJVODINA JUNIORI

Stepanovićevo, 09.04.2022.

JUNIORKE
+78KG
3 takmičarke

TAKMIČAR I KLUB	1	2	3	POBEDA	BODOVA	MESTO
1 TREĆAKOVIĆ, Katarina Sirmijum, Sremska Mitrovica		0	0	0	0	3
2 ORLOVIĆ, Katarina Ruma, Ruma	10		1	2	11	1
3 ZASKALICKI, Sara Ruma, Ruma	10	0		1	10	2

TREĆAKOVIĆ, Katarina	SRM	1	ORLOVIĆ, Katarina
ORLOVIĆ, Katarina	RUM		Ruma, Ruma
TREĆAKOVIĆ, Katarina	SRM	2	ZASKALICKI, Sara
ZASKALICKI, Sara	RUM		Ruma, Ruma
ORLOVIĆ, Katarina	RUM	3	ORLOVIĆ, Katarina
ZASKALICKI, Sara	RUM		Ruma, Ruma

Rezultati

1. ORLOVIĆ, Katarina RUM
2. ZASKALICKI, Sara RUM
3. TREĆAKOVIĆ, Katarina SRM