



VLADAN PETROVIĆ I DAN

Beograd, 13.04.2024.

STARIJI POLETARCI

-25KG

7 takmičara

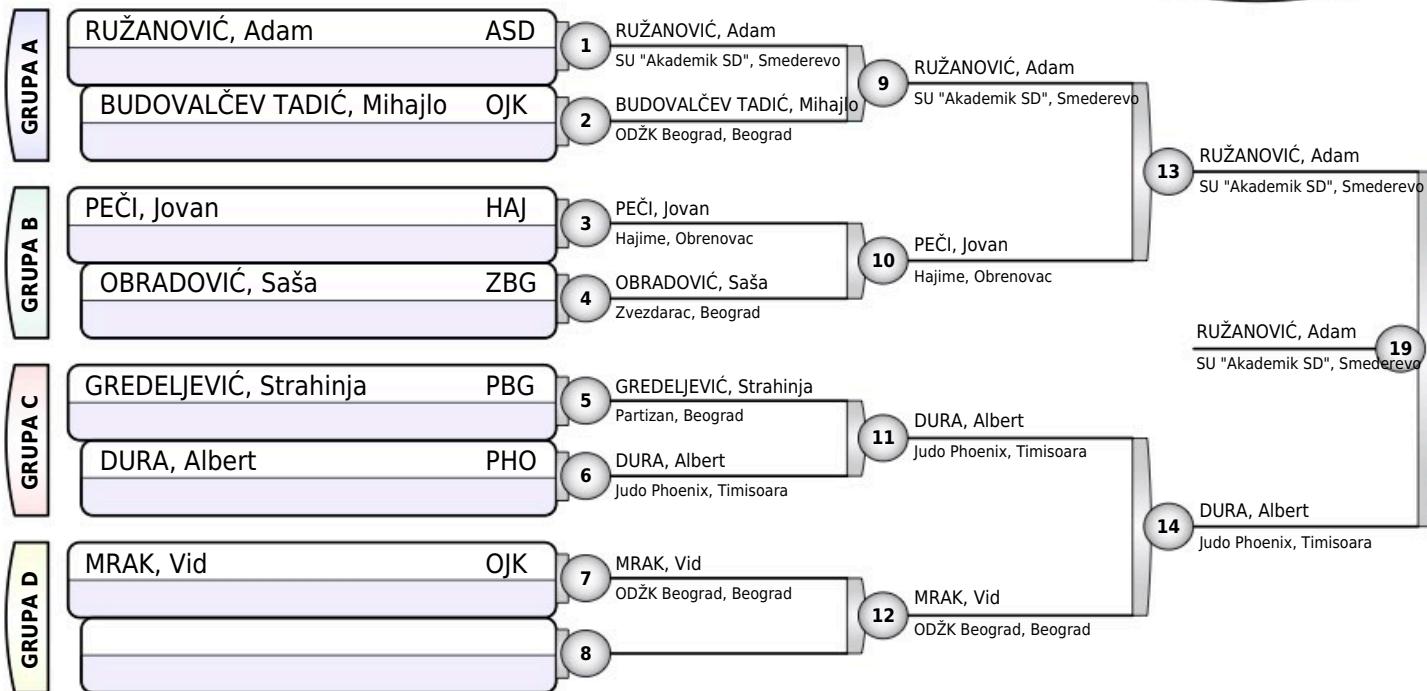

Rezultati

1. RUŽANOVIĆ, Adam ASD
2. DURA, Albert PHO
3. BUDOVALČEV TADIĆ, Mihajlo OJK
3. GREDELJEVIĆ, Strahinja PBG
5. PEČI, Jovan HAJ
5. MRAK, Vid OJK
- 7.
- 7.



VLADAN PETROVIĆ I DAN

Beograd, 13.04.2024.

STARIJI POLETARCI

-28KG

19 takmičara

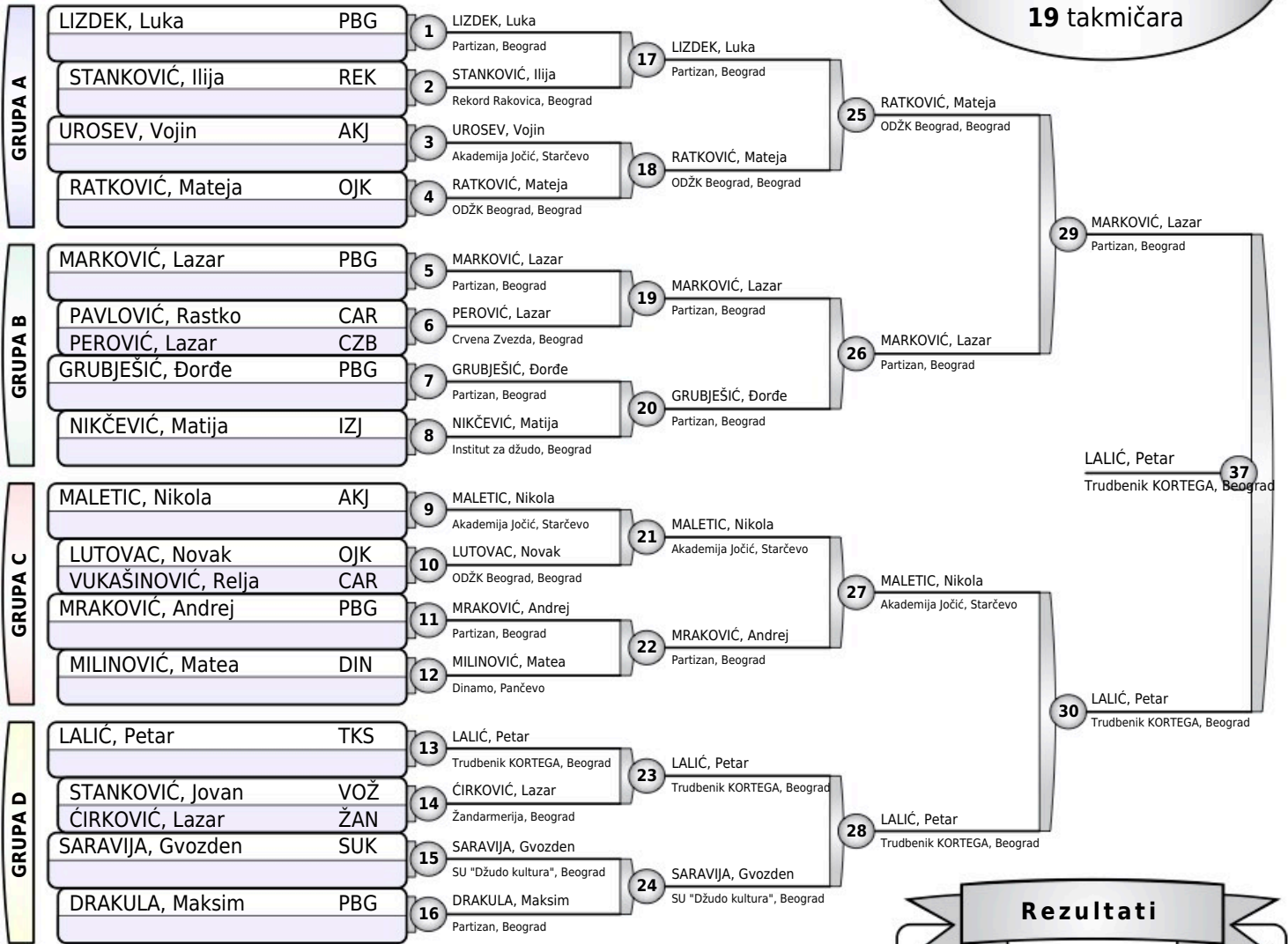

Rezultati

1. LALIĆ, Petar (TKS)
2. MARKOVIĆ, Lazar (PBG)
3. GRUBJEŠIĆ, Đorđe (PBG)
3. MALETIC, Nikola (AKJ)
5. RATKOVIĆ, Mateja (OJK)
5. SARA VIJA, Gvozden (SUK)
7. PEROVIĆ, Lazar (CZB)
7. ĆIRKOVIĆ, Lazar (ŽAN)



VLADAN PETROVIĆ I DAN

Beograd, 13.04.2024.

STARIJI POLETARCI

-31KG

26 takmičara

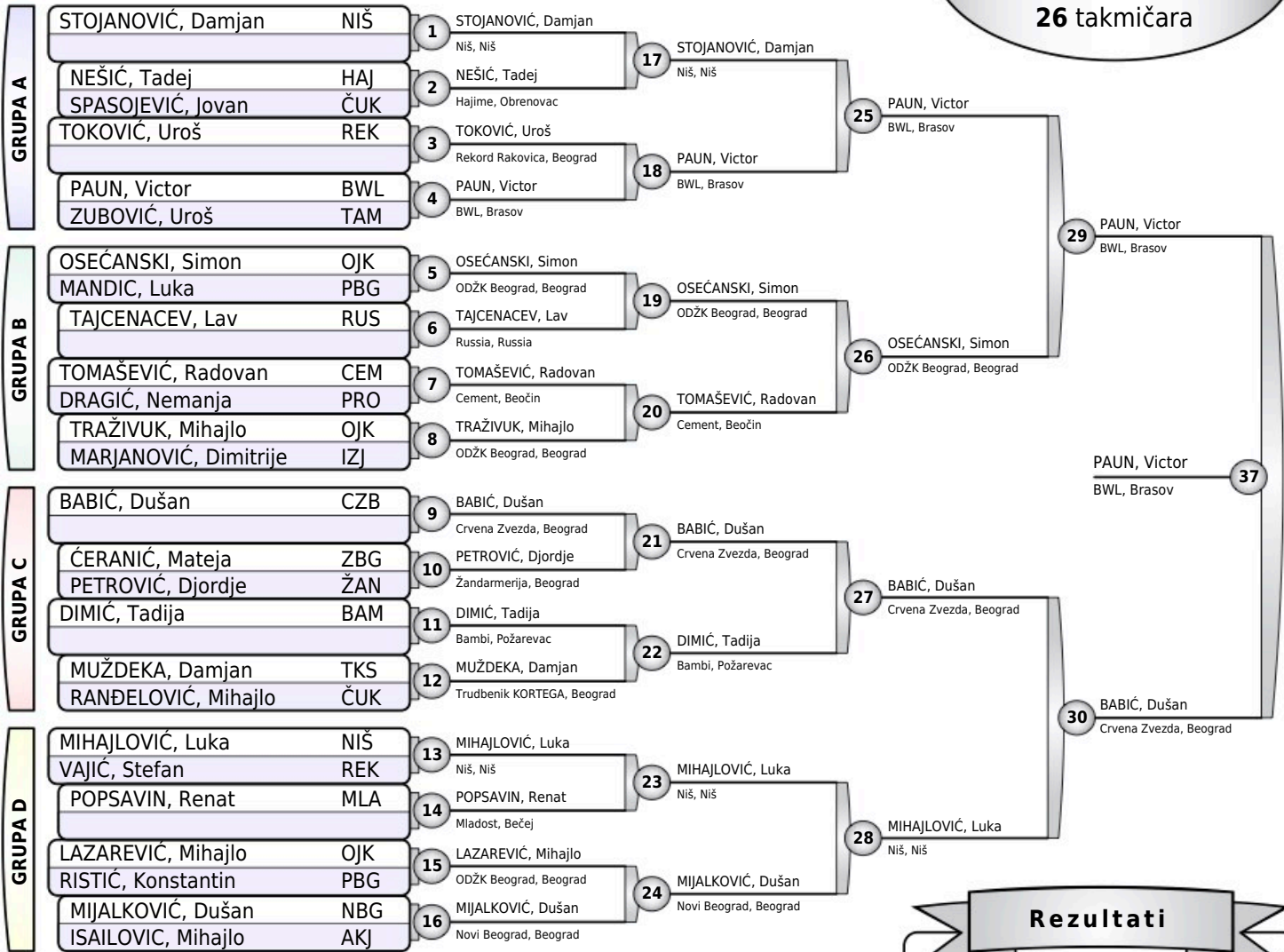

Rezultati

1. PAUN, Victor (BWL)
2. BABIĆ, Dušan (CZB)
3. STOJANOVIĆ, Damjan (NIŠ)
3. DIMIĆ, Tadija (BAM)
5. OSEČANSKI, Simon (OJK)
5. MIHAJLOVIĆ, Luka (NIŠ)
7. PETROVIĆ, Djordje (ŽAN)
7. ZUBOVIĆ, Uroš (TAM)



VLADAN PETROVIĆ I DAN

Beograd, 13.04.2024.

STARIJI POLETARCI

-34KG

19 takmičara

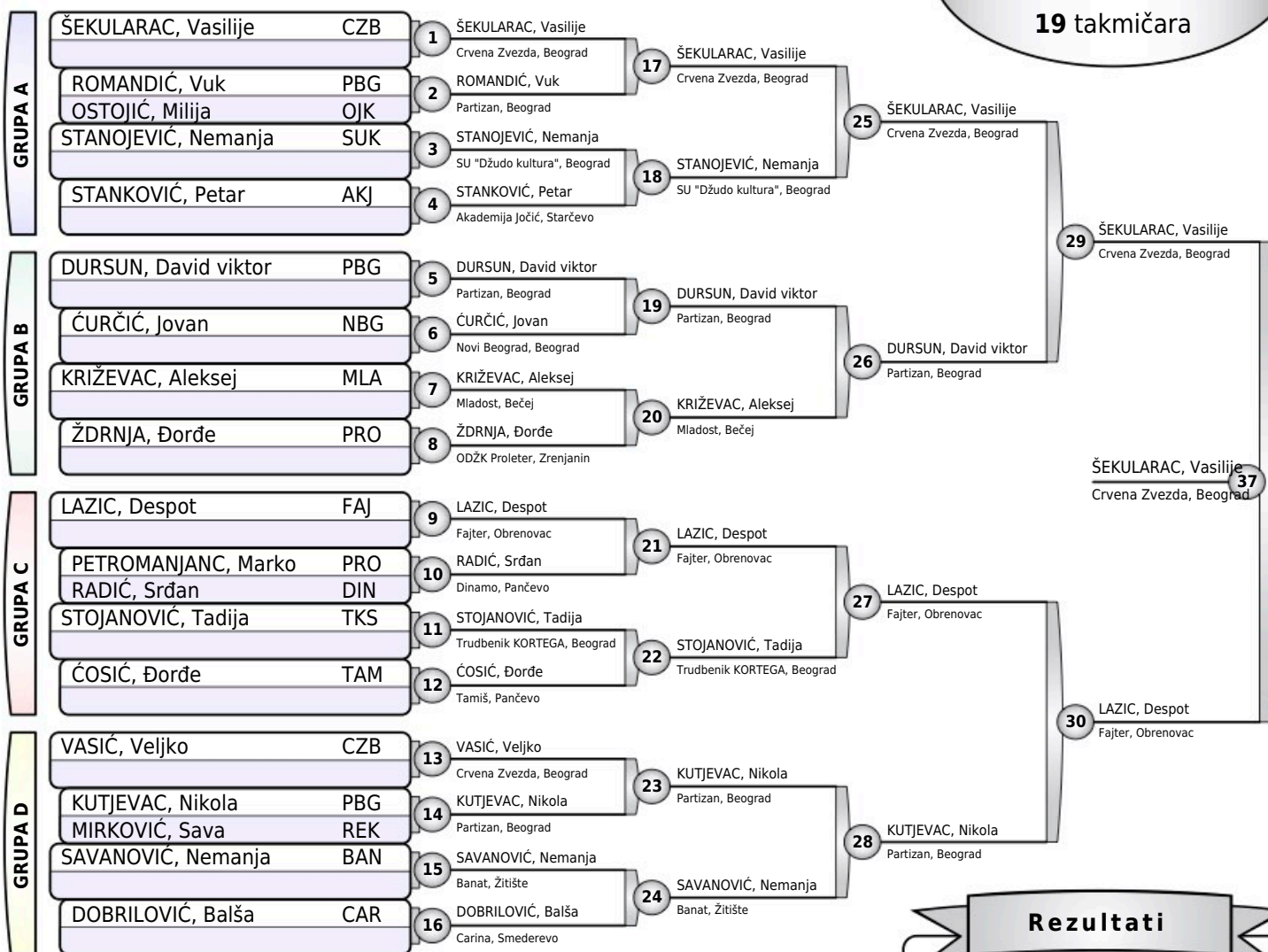

Rezultati

- ŠEKULARAC, Vasilije CZB
- LAZIC, Despot FAJ
- DURSUN, David viktor PBG
- KUTJEVAC, Nikola PBG
- STANOJEVIĆ, Nemanja SUK
- STOJANOVIĆ, Tadija TKS
- ROMANDIĆ, Vuk PBG
- RADIĆ, Srđan DIN



VLADAN PETROVIĆ I DAN

Beograd, 13.04.2024.

STARIJI POLETARCI

-38KG

21 takmičar

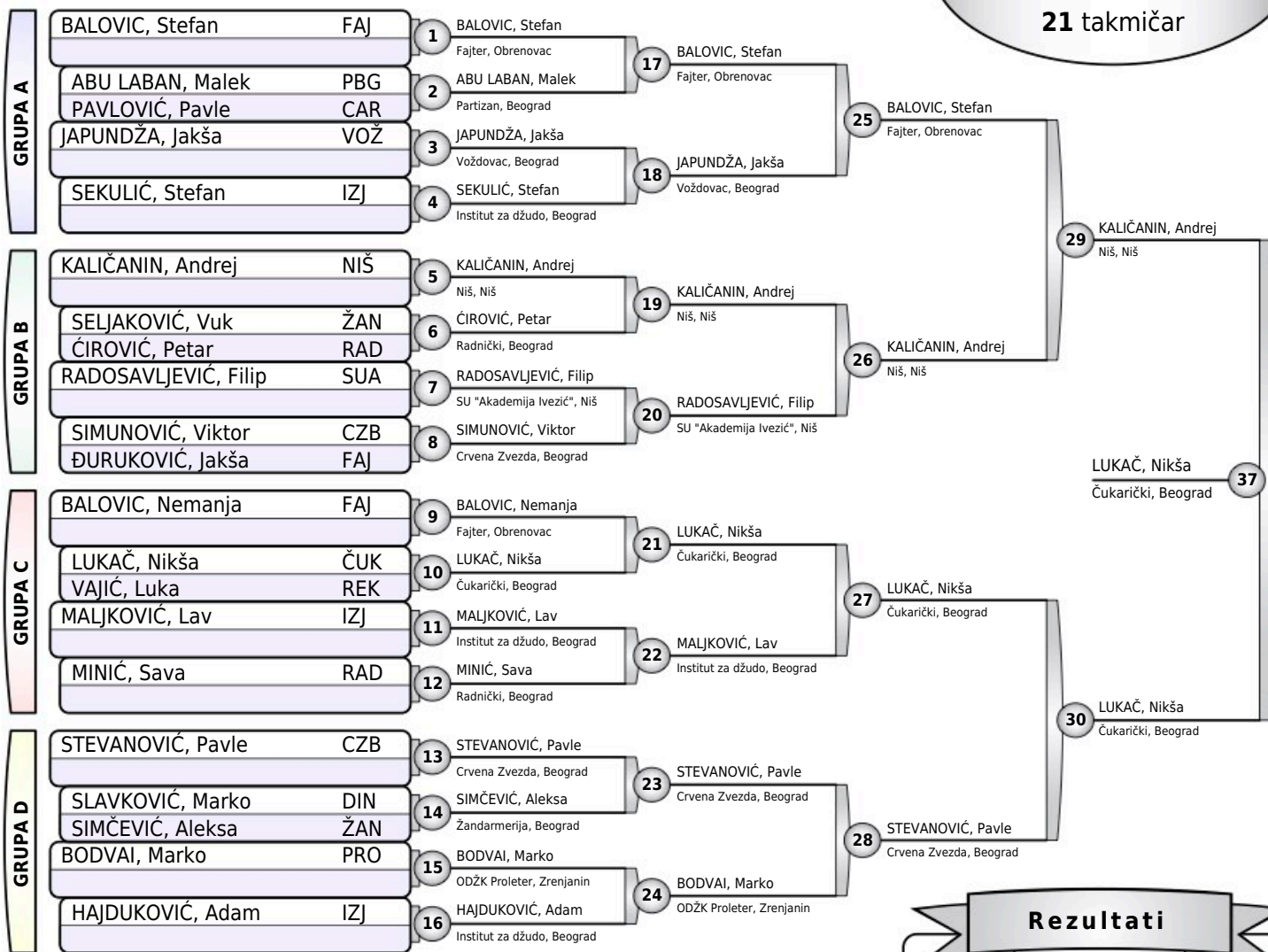

Rezultati

1. LUKAČ, Nikša ČUK
2. KALIČANIN, Andrej NIŠ
3. BALOVIC, Stefan FAJ
3. BALOVIC, Nemanja FAJ
5. RADOSAVLJEVIĆ, Filip SUA
5. STEVANOVIĆ, Pavle CZB
7. ČIROVIĆ, Petar RAD
7. MALJKOVIĆ, Lav IZJ



VLADAN PETROVIĆ I DAN

Beograd, 13.04.2024.

STARIJI POLETARCI

-42KG

15 takmičara

| GRUPA | Ime | Škola | Redni broj | Ime | Škola | Redni broj |
|---------|--------------------|-------|------------|--------------------|-----------------------------|----------------------------|
| GRUPA A | GRKOVIĆ, Andrej | AKJ | 1 | GRKOVIĆ, Andrej | Akademija Jočić, Starčevo | 9 |
| | RAJKOVIĆ, Vukašin | ŽAN | 2 | RAJKOVIĆ, Vukašin | Žandarmerija, Beograd | 10 |
| | VUKOVIĆ, Maksim | RAD | | | | |
| GRUPA B | TANKOSIĆ, Teodor | CZB | 3 | TANKOSIĆ, Teodor | Crvena Zvezda, Beograd | 10 |
| | STAJKOVIĆ, Veljko | TKS | 4 | TANKOSIĆ, Teodor | Crvena Zvezda, Beograd | |
| | STANOJEVIĆ, Vuk | OJK | | 4 | STANOJEVIĆ, Vuk | ODŽK Beograd, Beograd |
| | RACA, Robert | PHO | | | | |
| GRUPA C | MATIĆ, Vuk | 13U | 5 | MATIĆ, Vuk | 13. maj, Ub | 11 |
| | ZDRAVKOVIĆ, Nenad | AKJ | 6 | MATIĆ, Vuk | 13. maj, Ub | |
| | MITIĆ, Vukan | SUA | | 6 | MITIĆ, Vukan | SU "Akademija Ivezic", Niš |
| | GUŽVIĆ, Stefan | ZMA | | | | |
| GRUPA D | SIMONOVIĆ, Vukašin | ASD | 7 | SIMONOVIĆ, Vukašin | SU "Akademik SD", Smederevo | 12 |
| | GALAC, Đorđe | OJK | 8 | SIMONOVIĆ, Vukašin | SU "Akademik SD", Smederevo | |
| | LAZIĆ, Mihajlo | 13U | | 8 | LAZIĆ, Mihajlo | 13. maj, Ub |
| | PERIŠIĆ, Jovan | REK | | | | |

Rezultati

1. SIMONOVIĆ, Vukašin ASD
2. TANKOSIĆ, Teodor CZB
3. GRKOVIĆ, Andrej AKJ
3. LAZIĆ, Mihajlo 13U
5. STANOJEVIĆ, Vuk OJK
5. MATIĆ, Vuk 13U
7. STAJKOVIĆ, Veljko TKS
7. GALAC, Đorđe OJK

| REPASAŽ | Ime | Škola | Redni broj | Ime | Škola | Redni broj |
|---------|-------------------|-------|------------|-----------------|---------------------------|------------|
| REPASAŽ | STAJKOVIĆ, Veljko | TKS | 15 | STANOJEVIĆ, Vuk | ODŽK Beograd, Beograd | 17 |
| | STANOJEVIĆ, Vuk | OJK | | GRKOVIĆ, Andrej | Akademija Jočić, Starčevo | |
| REPASAŽ | GALAC, Đorđe | OJK | 16 | LAZIĆ, Mihajlo | 13. maj, Ub | 18 |
| | LAZIĆ, Mihajlo | 13U | | MATIĆ, Vuk | 13. maj, Ub | |
| | | | | | | |



VLADAN PETROVIĆ I DAN

Beograd, 13.04.2024.

STARIJI POLETARCI

-46KG

11 takmičara

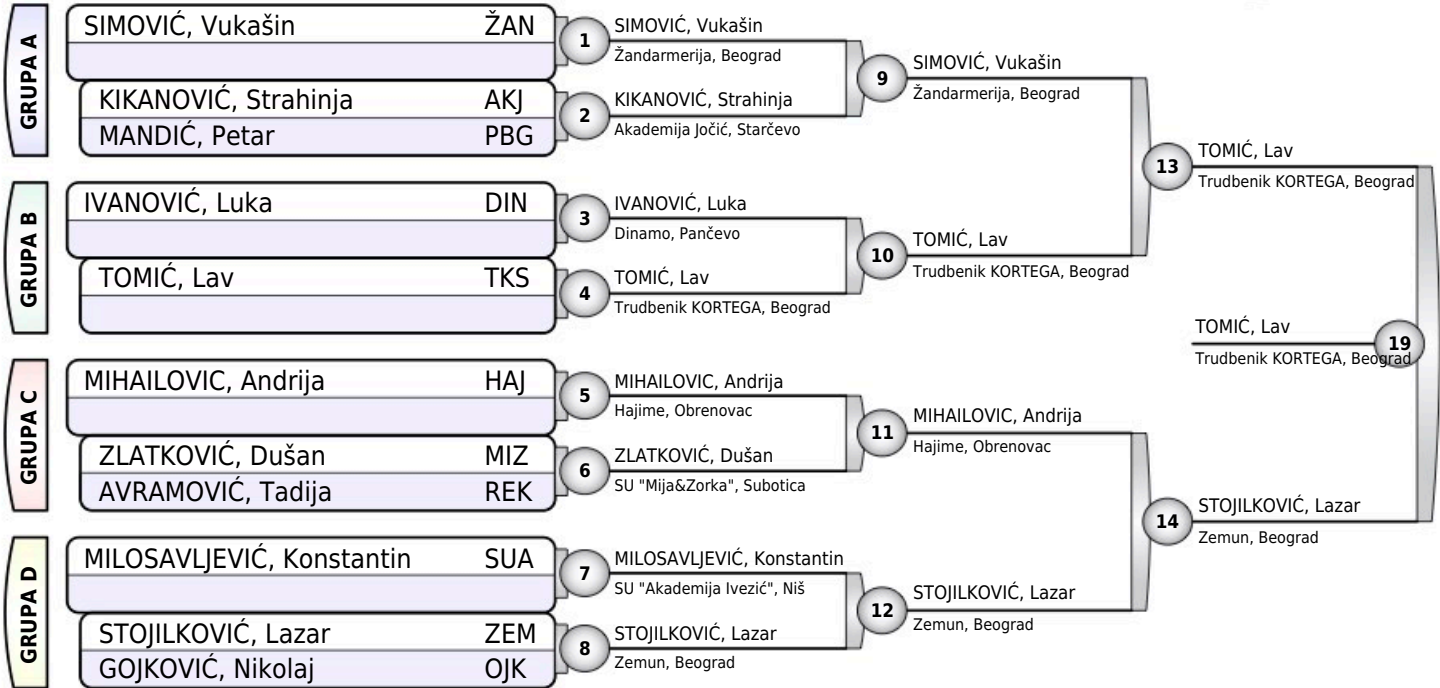

Rezultati

1. TOMIĆ, Lav TKS
2. STOJILKOVIĆ, Lazar ZEM
3. SIMOVIĆ, Vukašin ŽAN
3. MIHAILOVIC, Andrija HAJ
5. IVANOVIĆ, Luka DIN
5. MILOSAVLJEVIĆ, Konstantin SUA
7. GOJKOVIĆ, Nikolaj OJK
- 7.

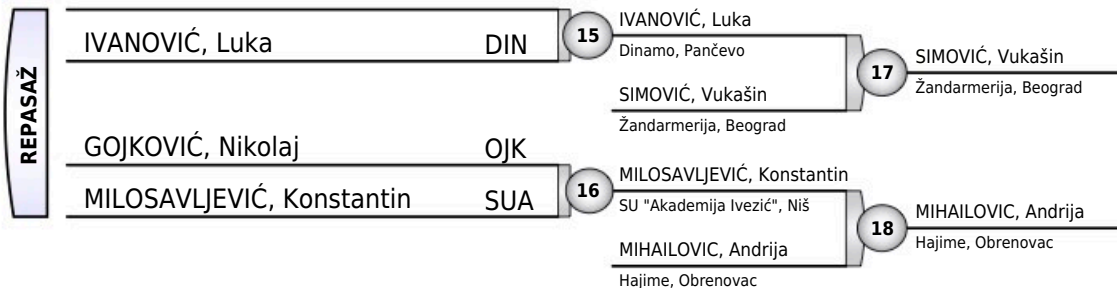



VLADAN PETROVIĆ I DAN

Beograd, 13.04.2024.

STARIJI POLETARCI

-50KG

5 takmičara

| TAKMIČAR I KLUB | 1 | 2 | 3 | 4 | 5 | POBEDA | BODOVA | MESTO |
|--|-----|-----|-----|-----|-----|--------|--------|-------|
| 1 MILOJEVIĆ, Jovan Žandarmerija, Beograd | --- | 0 | 0 | 10 | 0 | 1 | 10 | 3 |
| 2 NEŠKOVIĆ, Luka Partizan, Beograd | 10 | --- | 10 | 10 | 10 | 4 | 40 | 1 |
| 3 MILOŠEVIĆ, Maksim Jedinstvo, Kačarevo | 10 | 0 | --- | 10 | 0 | 2 | 20 | 3 |
| 4 TODOROVIĆ, Petar Institut za džudo, Beograd | 0 | 0 | 0 | --- | 0 | 0 | 0 | 5 |
| 5 POPOVIĆ, Stanko ODŽK Beograd, Beograd | 10 | 0 | 10 | 10 | --- | 3 | 30 | 2 |

| | | | |
|-------------------|-----|----|-----------------------|
| MILOJEVIĆ, Jovan | ŽAN | 1 | NEŠKOVIĆ, Luka |
| NEŠKOVIĆ, Luka | PBG | | Partizan, Beograd |
| MILOŠEVIĆ, Maksim | JED | 2 | MILOŠEVIĆ, Maksim |
| TODOROVIĆ, Petar | IZJ | | Jedinstvo, Kačarevo |
| MILOJEVIĆ, Jovan | ŽAN | 3 | POPOVIĆ, Stanko |
| POPOVIĆ, Stanko | OJK | | ODŽK Beograd, Beograd |
| NEŠKOVIĆ, Luka | PBG | 4 | NEŠKOVIĆ, Luka |
| MILOŠEVIĆ, Maksim | JED | | Partizan, Beograd |
| TODOROVIĆ, Petar | IZJ | 5 | POPOVIĆ, Stanko |
| POPOVIĆ, Stanko | OJK | | ODŽK Beograd, Beograd |
| MILOJEVIĆ, Jovan | ŽAN | 6 | MILOŠEVIĆ, Maksim |
| MILOŠEVIĆ, Maksim | JED | | Jedinstvo, Kačarevo |
| NEŠKOVIĆ, Luka | PBG | 7 | NEŠKOVIĆ, Luka |
| TODOROVIĆ, Petar | IZJ | | Partizan, Beograd |
| MILOŠEVIĆ, Maksim | JED | 8 | POPOVIĆ, Stanko |
| POPOVIĆ, Stanko | OJK | | ODŽK Beograd, Beograd |
| MILOJEVIĆ, Jovan | ŽAN | 9 | MILOJEVIĆ, Jovan |
| TODOROVIĆ, Petar | IZJ | | Žandarmerija, Beograd |
| NEŠKOVIĆ, Luka | PBG | 10 | NEŠKOVIĆ, Luka |
| POPOVIĆ, Stanko | OJK | | Partizan, Beograd |

Rezultati

1. NEŠKOVIĆ, Luka PBG
2. POPOVIĆ, Stanko OJK
3. MILOŠEVIĆ, Maksim JED
3. MILOJEVIĆ, Jovan ŽAN
5. TODOROVIĆ, Petar IZJ



VLADAN PETROVIĆ I DAN

Beograd, 13.04.2024.

STARIJI POLETARCI

+50KG

5 takmičara

| TAKMIČAR I KLUB | 1 | 2 | 3 | 4 | 5 | POBEDA | BODOVA | MESTO |
|---|-----|-----|-----|-----|-----|--------|--------|-------|
| 1 MILIĆ, Pavle Bambi, Požarevac | --- | 0 | 0 | 0 | 0 | 0 | 0 | 5 |
| 2 GLOZIK, Ivan Jedinstvo, Kačarevo | 10 | --- | 10 | 0 | 10 | 3 | 30 | 2 |
| 3 DUKIĆ, Marko Crvena Zvezda, Beograd | 10 | 0 | --- | 0 | 10 | 2 | 20 | 3 |
| 4 ČIGOJA, Radan Jedinstvo, Kačarevo | 10 | 1 | 10 | --- | 10 | 4 | 31 | 1 |
| 5 MARKOVIĆ, Petar Knjaz Miloš, Beograd | 10 | 0 | 0 | 0 | --- | 1 | 10 | 3 |

| | | | |
|-----------------|-----|----|------------------------|
| MILIĆ, Pavle | BAM | 1 | GLOZIK, Ivan |
| GLOZIK, Ivan | JED | | Jedinstvo, Kačarevo |
| DUKIĆ, Marko | CZB | 2 | ČIGOJA, Radan |
| ČIGOJA, Radan | JED | | Jedinstvo, Kačarevo |
| MILIĆ, Pavle | BAM | 3 | MARKOVIĆ, Petar |
| MARKOVIĆ, Petar | KNJ | | Knjaz Miloš, Beograd |
| GLOZIK, Ivan | JED | 4 | GLOZIK, Ivan |
| DUKIĆ, Marko | CZB | | Jedinstvo, Kačarevo |
| ČIGOJA, Radan | JED | 5 | ČIGOJA, Radan |
| MARKOVIĆ, Petar | KNJ | | Jedinstvo, Kačarevo |
| MILIĆ, Pavle | BAM | 6 | DUKIĆ, Marko |
| DUKIĆ, Marko | CZB | | Crvena Zvezda, Beograd |
| GLOZIK, Ivan | JED | 7 | ČIGOJA, Radan |
| ČIGOJA, Radan | JED | | Jedinstvo, Kačarevo |
| DUKIĆ, Marko | CZB | 8 | DUKIĆ, Marko |
| MARKOVIĆ, Petar | KNJ | | Crvena Zvezda, Beograd |
| MILIĆ, Pavle | BAM | 9 | ČIGOJA, Radan |
| ČIGOJA, Radan | JED | | Jedinstvo, Kačarevo |
| GLOZIK, Ivan | JED | 10 | GLOZIK, Ivan |
| MARKOVIĆ, Petar | KNJ | | Jedinstvo, Kačarevo |

Rezultati

- | | |
|--------------------|-----|
| 1. ČIGOJA, Radan | JED |
| 2. GLOZIK, Ivan | JED |
| 3. DUKIĆ, Marko | CZB |
| 3. MARKOVIĆ, Petar | KNJ |
| 5. MILIĆ, Pavle | BAM |



VLADAN PETROVIĆ I DAN

Beograd, 13.04.2024.

STARIJE POLETARKE

-22KG

2 takmičarke

| | | | |
|-------------------|-----|---|------------------|
| DUBLJEVIĆ, Dunja | 13U | 1 | DUBLJEVIĆ, Dunja |
| MILETIĆ, Nikolija | KAR | | 13. maj, Ub |
| DUBLJEVIĆ, Dunja | 13U | 2 | DUBLJEVIĆ, Dunja |
| MILETIĆ, Nikolija | KAR | | 13. maj, Ub |
| | | 3 | |

Rezultati

1. DUBLJEVIĆ, Dunja 13U
2. MILETIĆ, Nikolija KAR



VLADAN PETROVIĆ I DAN

Beograd, 13.04.2024.

STARIJE POLETARKE

-25KG

3 takmičarke

| TAKMIČAR I KLUB | 1 | 2 | 3 | POBEDA | BODOVA | MESTO |
|---|---|----|----|--------|--------|-------|
| 1 MILJANOVIĆ, Milana Cement, Beočin | | 10 | 10 | 2 | 20 | 1 |
| 2 NEŠOVIĆ, Minja Institut za džudo, Beograd | 0 | | 0 | 0 | 0 | 3 |
| 3 ALEKSIĆ, Lenka SU "Džudo kultura", Beograd | 0 | 10 | | 1 | 10 | 2 |

| | | | |
|--------------------|-----|---|-----------------------------|
| MILJANOVIĆ, Milana | CEM | 1 | MILJANOVIĆ, Milana |
| NEŠOVIĆ, Minja | IZJ | | Cement, Beočin |
| MILJANOVIĆ, Milana | CEM | 2 | MILJANOVIĆ, Milana |
| ALEKSIĆ, Lenka | SUK | | Cement, Beočin |
| NEŠOVIĆ, Minja | IZJ | 3 | ALEKSIĆ, Lenka |
| ALEKSIĆ, Lenka | SUK | | SU "Džudo kultura", Beograd |

Rezultati

- MILJANOVIĆ, Milana CEM
- ALEKSIĆ, Lenka SUK
- NEŠOVIĆ, Minja IZJ



VLADAN PETROVIĆ I DAN

Beograd, 13.04.2024.

STARIJE POLETARKE

-28KG

7 takmičarki

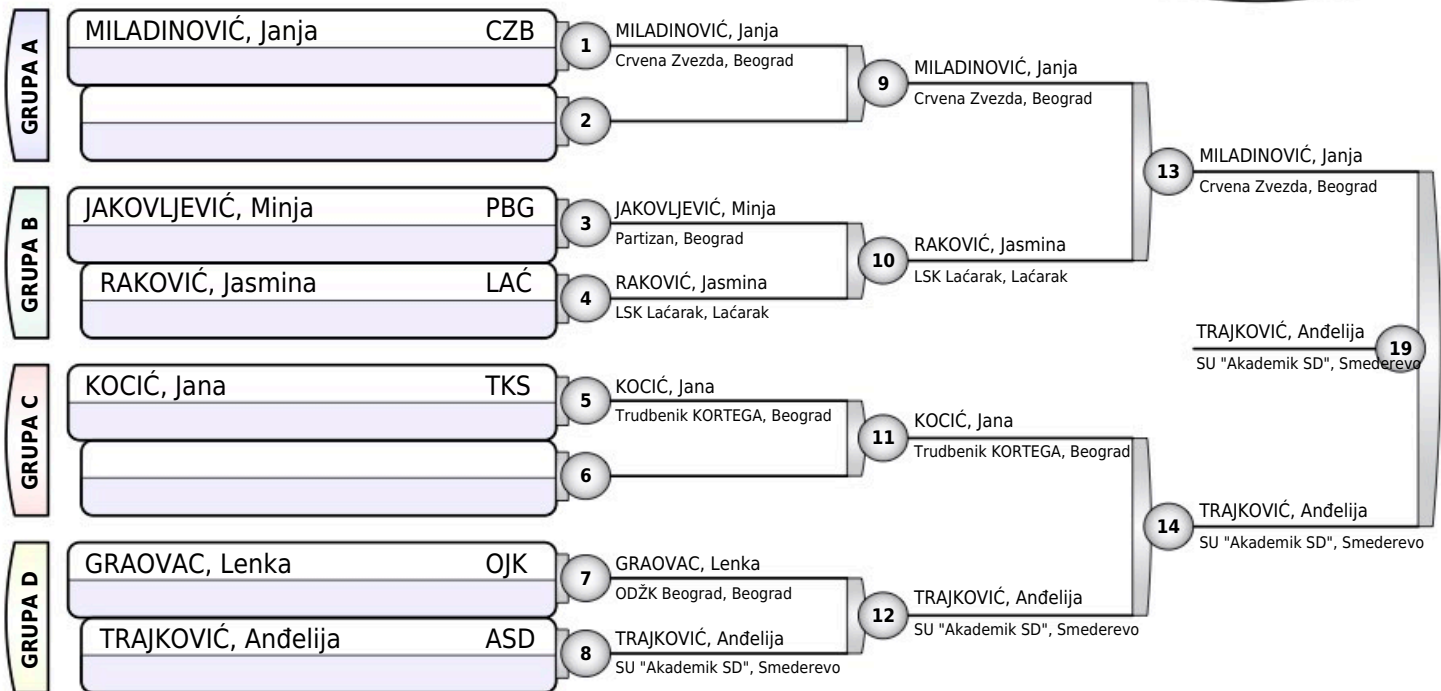

Rezultati

1. TRAJKOVIĆ, Anđelija ASD
2. MILADINOVIĆ, Janja CZB
3. KOCIĆ, Jana TKS
3. RAKOVIĆ, Jasmina LAĆ
5. GRAOVAC, Lenka OJK
- 5.
- 7.
- 7.



VLADAN PETROVIĆ I DAN

Beograd, 13.04.2024.

STARIJE POLETARKE

-31KG

8 takmičarki

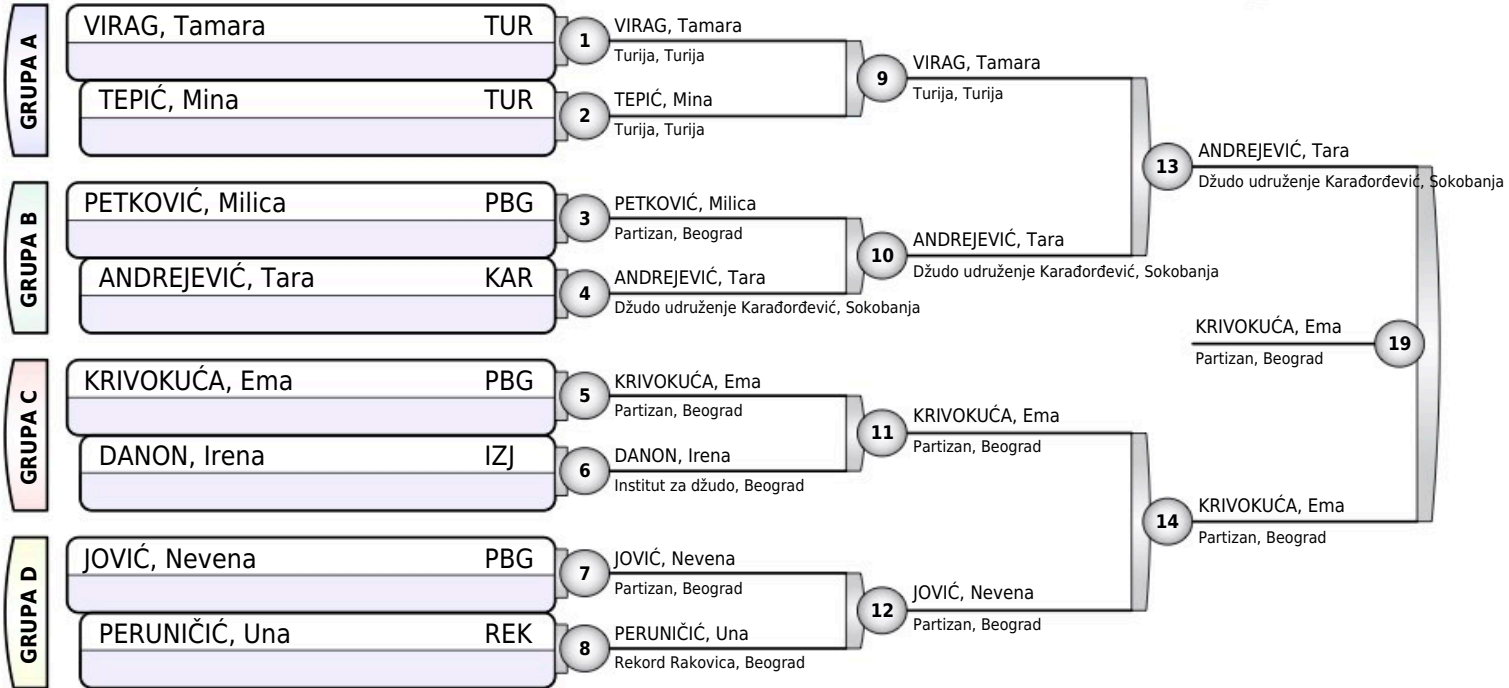

Rezultati

1. KRIVOKUĆA, Ema (PBG)
2. ANDREJEVIĆ, Tara (KAR)
3. VIRAG, Tamara (TUR)
3. JOVIĆ, Nevena (PBG)
5. PETKOVIĆ, Milica (PBG)
5. DANON, Irena (IZJ)
- 7.
- 7.

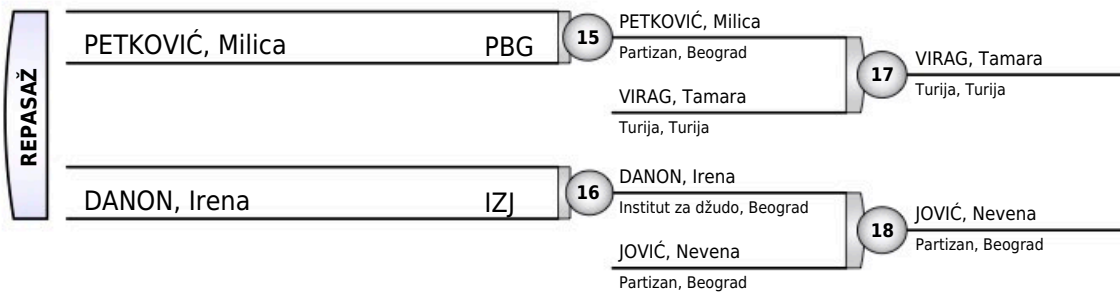



VLADAN PETROVIĆ I DAN

Beograd, 13.04.2024.

STARIJE POLETARKE

-34KG

11 takmičarki

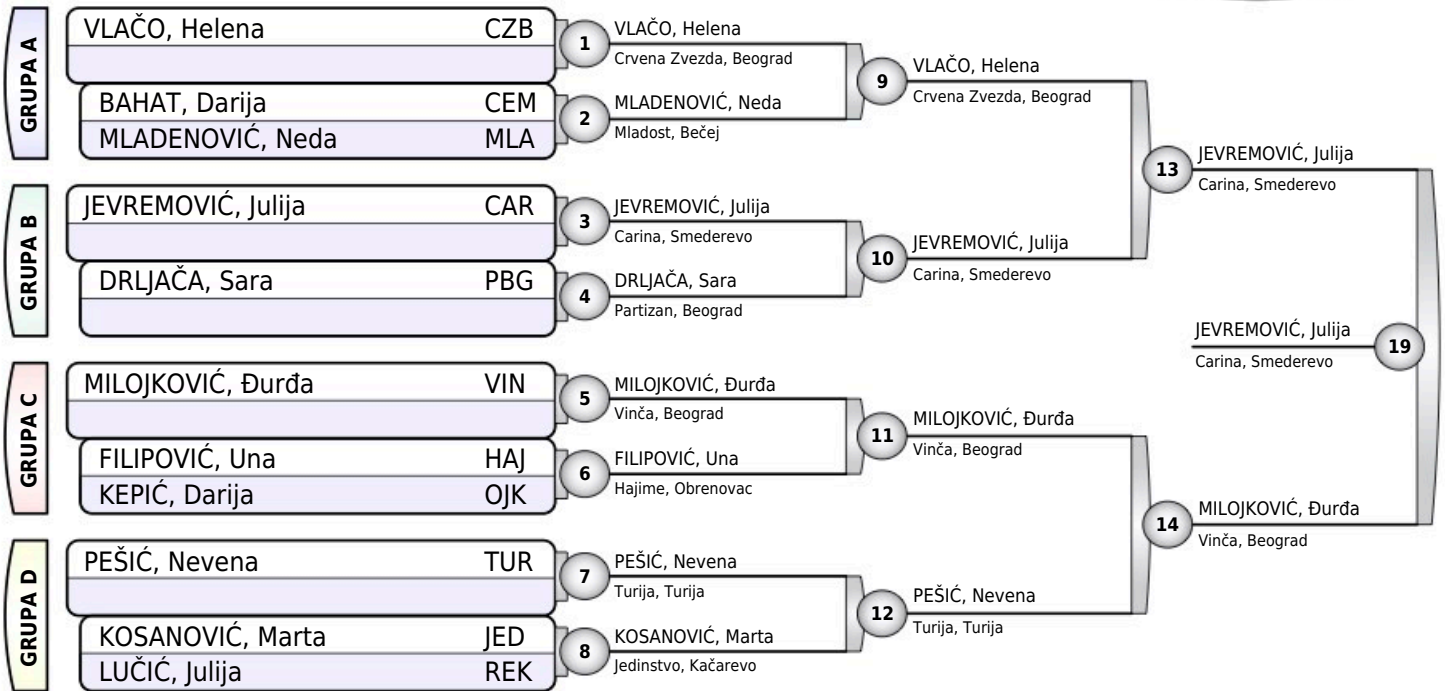

Rezultati

1. JEVREMOVIĆ, Julija CAR
2. MILOJKOVIĆ, Đurđa VIN
3. DRLJAČA, Sara PBG
3. PEŠIĆ, Nevena TUR
5. VLAČO, Helena CZB
5. FILIPOVIĆ, Una HAJ
- 7.
- 7.

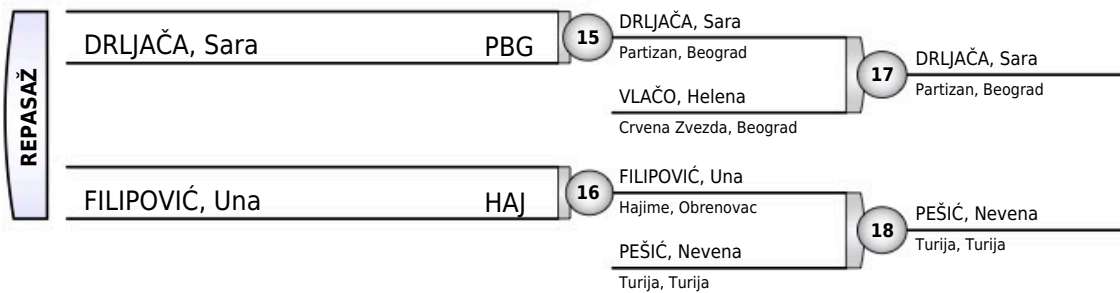



VLADAN PETROVIĆ I DAN

Beograd, 13.04.2024.

STARIJE POLETARKE

-38KG

7 takmičarki

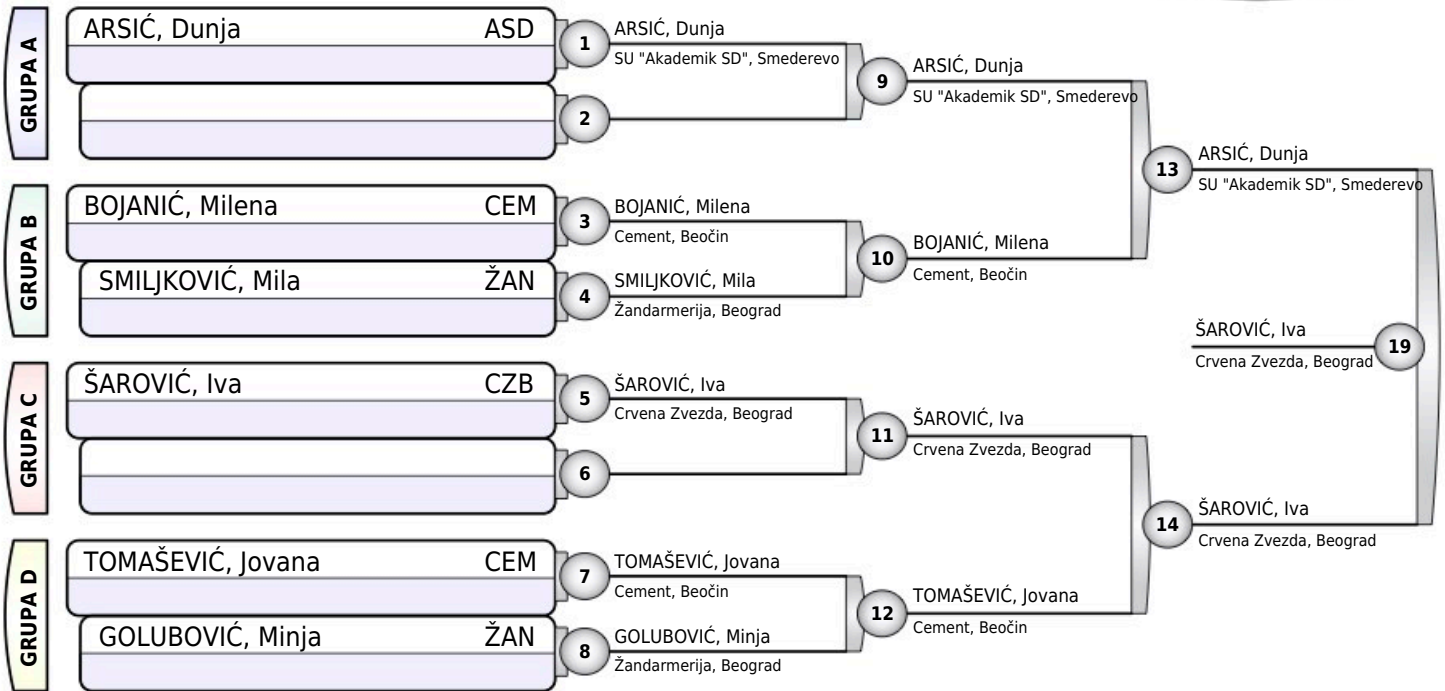

Rezultati

1. ŠAROVIĆ, Iva CZB
2. ARSIĆ, Dunja ASD
3. BOJANIĆ, Milena CEM
3. TOMAŠEVIĆ, Jovana CEM
- 5.
- 5.
- 7.
- 7.

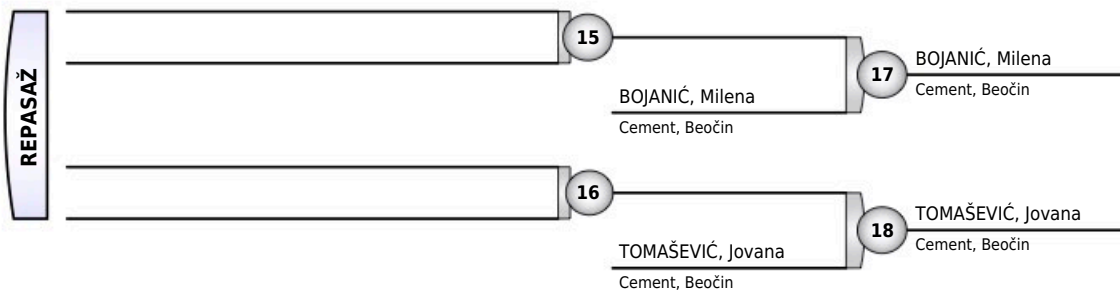



VLADAN PETROVIĆ I DAN

Beograd, 13.04.2024.

STARIJE POLETARKE

-43KG

9 takmičarki

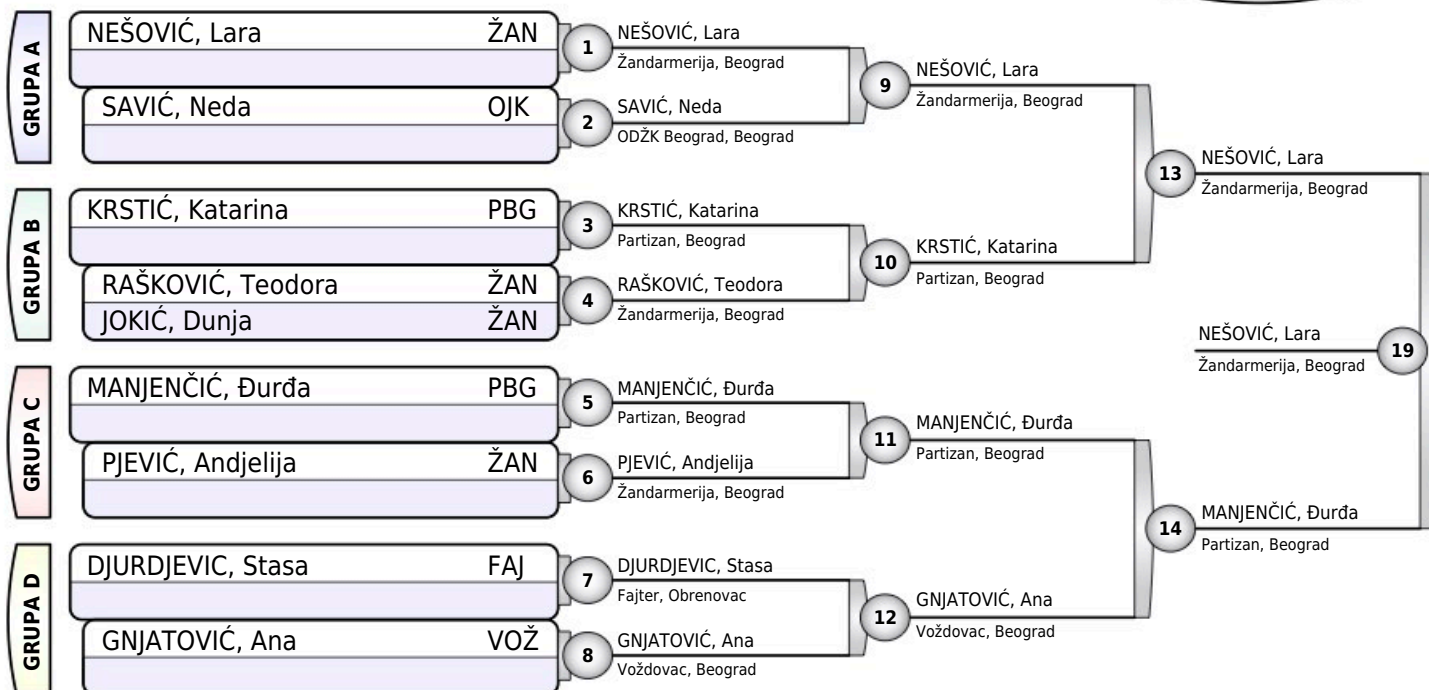

Rezultati

1. NEŠOVIĆ, Lara ŽAN
2. MANJENČIĆ, Đurđa PBG
3. KRSTIĆ, Katarina PBG
3. GNJATOVIĆ, Ana VOŽ
5. SAVIĆ, Neda OJK
5. PJEVIĆ, Andjelija ŽAN
- 7.
- 7.





VLADAN PETROVIĆ I DAN

Beograd, 13.04.2024.

STARIJE POLETARKE

+43KG

5 takmičarki

| TAKMIČAR I KLUB | 1 | 2 | 3 | 4 | 5 | POBEDA | BODOVA | MESTO |
|--|----|----|----|----|---|--------|--------|-------|
| 1 TOROK, Emese meso Hód Judo SE, Hódmezővásárhely | | 1 | 10 | 10 | 0 | 3 | 21 | 2 |
| 2 POUČKI, Hana Mladost, Bečej | 0 | | 0 | 10 | 0 | 1 | 10 | 3 |
| 3 ILIĆ, Emilija Jedinstvo, Kačarevo | 0 | 10 | | 10 | 0 | 2 | 20 | 3 |
| 4 JOKSIMOVIĆ, Helena Fajter, Obrenovac | 0 | 0 | 0 | | 0 | 0 | 0 | 5 |
| 5 STEPANOVIĆ, Mila SU "Akademik SD", Smederevo | 10 | 10 | 10 | 10 | | 4 | 40 | 1 |

| | | | |
|--------------------|-----|----|-------------------------------|
| TOROK, Emese meso | HJS | 1 | TOROK, Emese meso |
| POUČKI, Hana | MLA | | Hód Judo SE, Hódmezővásárhely |
| ILIĆ, Emilija | JED | 2 | ILIĆ, Emilija |
| JOKSIMOVIĆ, Helena | FAJ | | Jedinstvo, Kačarevo |
| TOROK, Emese meso | HJS | 3 | STEPANOVIĆ, Mila |
| STEPANOVIĆ, Mila | ASD | | SU "Akademik SD", Smederevo |
| POUČKI, Hana | MLA | 4 | ILIĆ, Emilija |
| ILIĆ, Emilija | JED | | Jedinstvo, Kačarevo |
| JOKSIMOVIĆ, Helena | FAJ | 5 | STEPANOVIĆ, Mila |
| STEPANOVIĆ, Mila | ASD | | SU "Akademik SD", Smederevo |
| TOROK, Emese meso | HJS | 6 | TOROK, Emese meso |
| ILIĆ, Emilija | JED | | Hód Judo SE, Hódmezővásárhely |
| POUČKI, Hana | MLA | 7 | POUČKI, Hana |
| JOKSIMOVIĆ, Helena | FAJ | | Mladost, Bečej |
| ILIĆ, Emilija | JED | 8 | STEPANOVIĆ, Mila |
| STEPANOVIĆ, Mila | ASD | | SU "Akademik SD", Smederevo |
| TOROK, Emese meso | HJS | 9 | TOROK, Emese meso |
| JOKSIMOVIĆ, Helena | FAJ | | Hód Judo SE, Hódmezővásárhely |
| POUČKI, Hana | MLA | 10 | STEPANOVIĆ, Mila |
| STEPANOVIĆ, Mila | ASD | | SU "Akademik SD", Smederevo |

Rezultati

- STEPANOVIĆ, Mila ASD
- TOROK, Emese meso HJS
- ILIĆ, Emilija JED
- POUČKI, Hana MLA
- JOKSIMOVIĆ, Helena FAJ



VLADAN PETROVIĆ I DAN

Beograd, 13.04.2024.

MLAĐI DEČACI

-30KG

11 takmičara

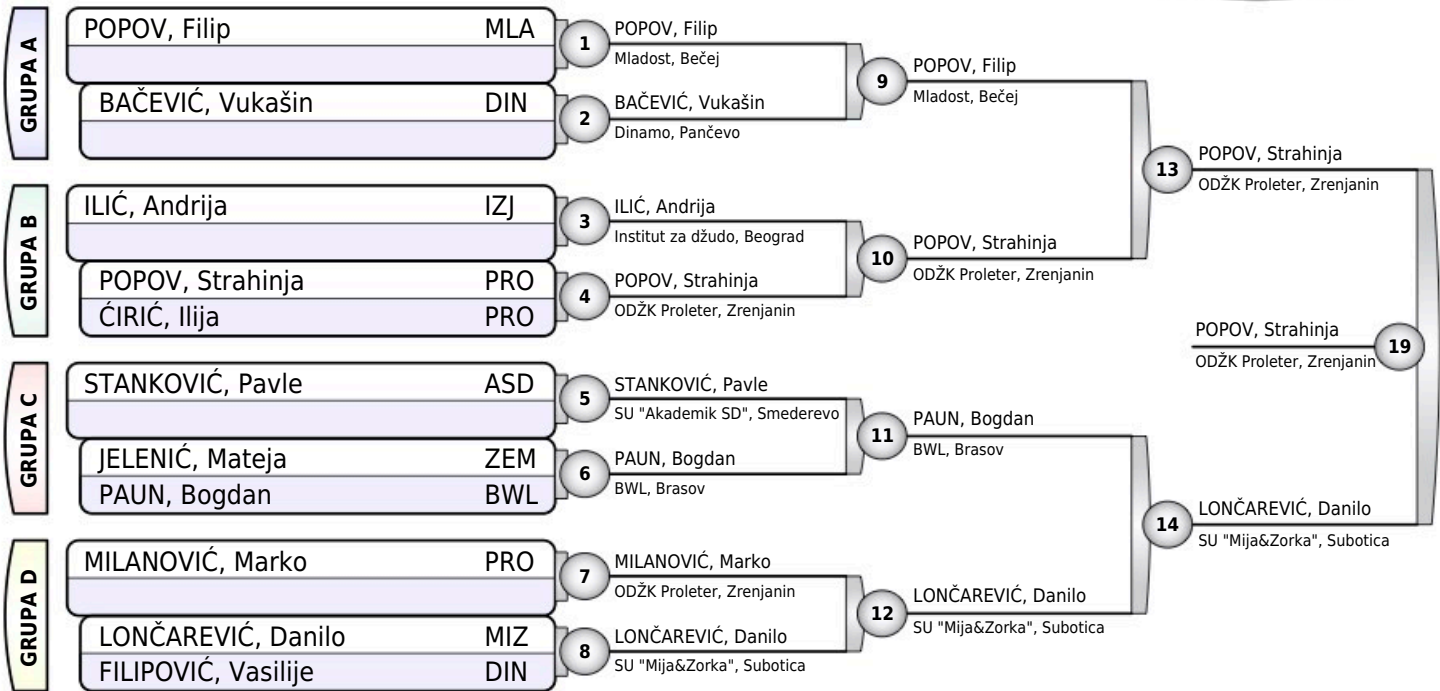

Rezultati

1. POPOV, Strahinja PRO
2. LONČAREVIĆ, Danilo MIZ
3. POPOV, Filip MLA
3. MILANOVIĆ, Marko PRO
5. ĆIRIĆ, Ilija PRO
5. PAUN, Bogdan BWL
7. ILIĆ, Andrija IZJ
7. FILIPOVIĆ, Vasilije DIN

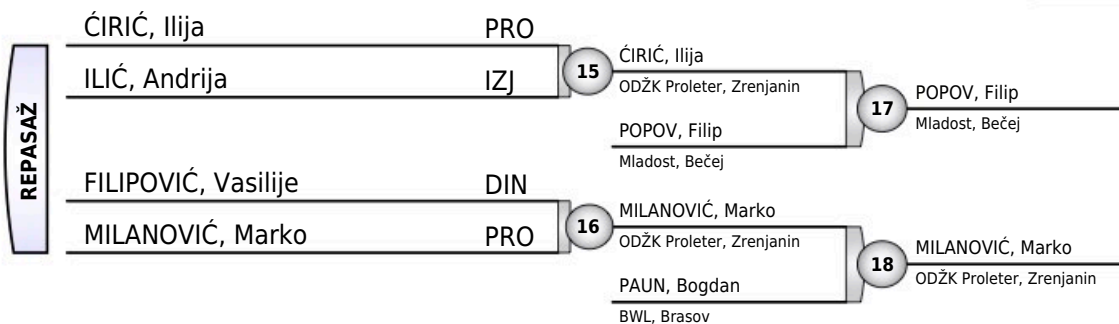



VLADAN PETROVIĆ I DAN

Beograd, 13.04.2024.

MLAĐI DEČACI

-34KG

21 takmičar

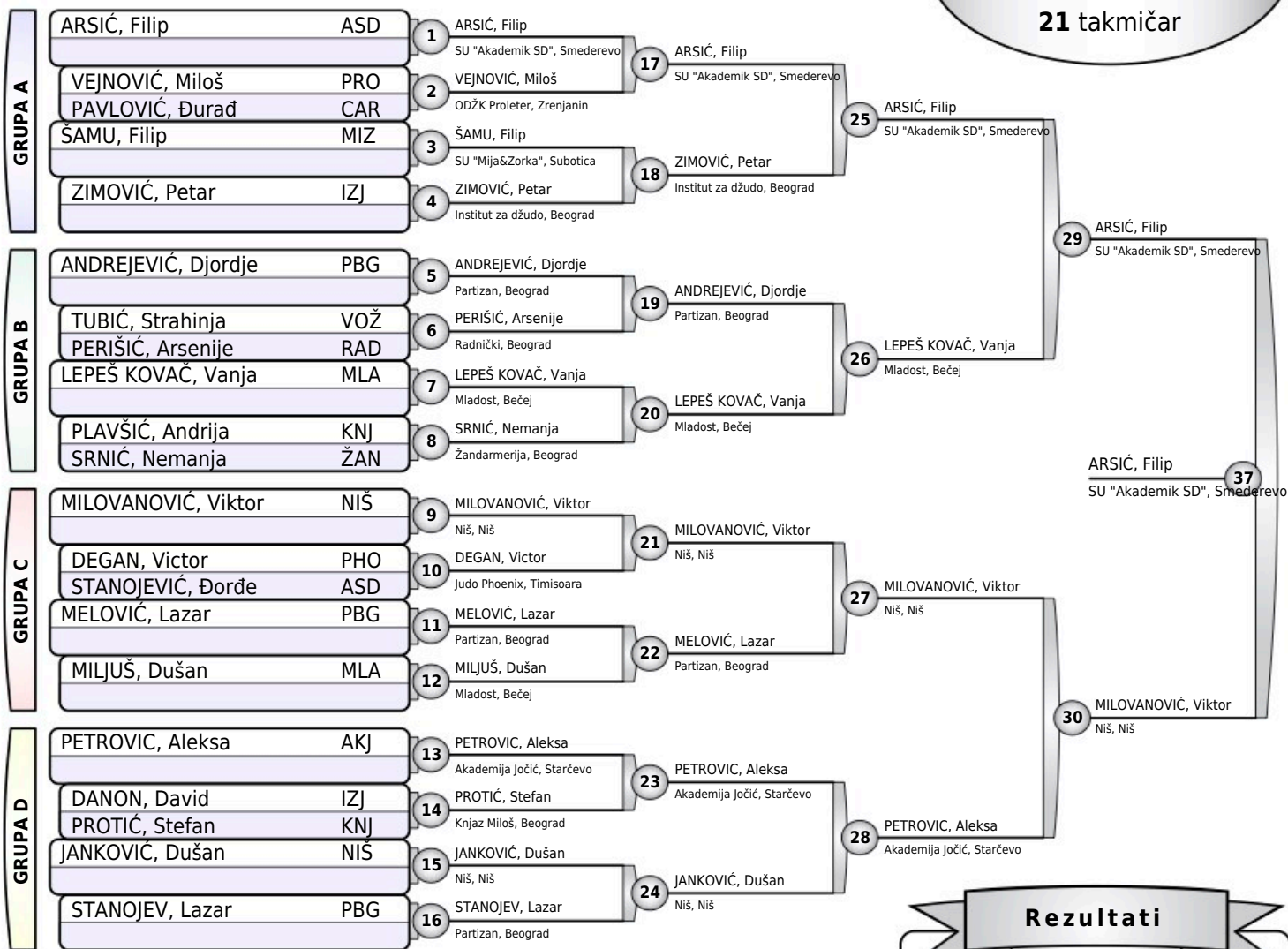

Rezultati

1. ARSIĆ, Filip ASD
2. MILOVANOVIĆ, Viktor NIŠ
3. LEPEŠ KOVAČ, Vanja MLA
3. PETROVIC, Aleksa AKJ
5. VEJNOVIĆ, Miloš PRO
5. DEGAN, Victor PHO
7. ZIMOVIĆ, Petar IZJ
7. MELOVIĆ, Lazar PBG

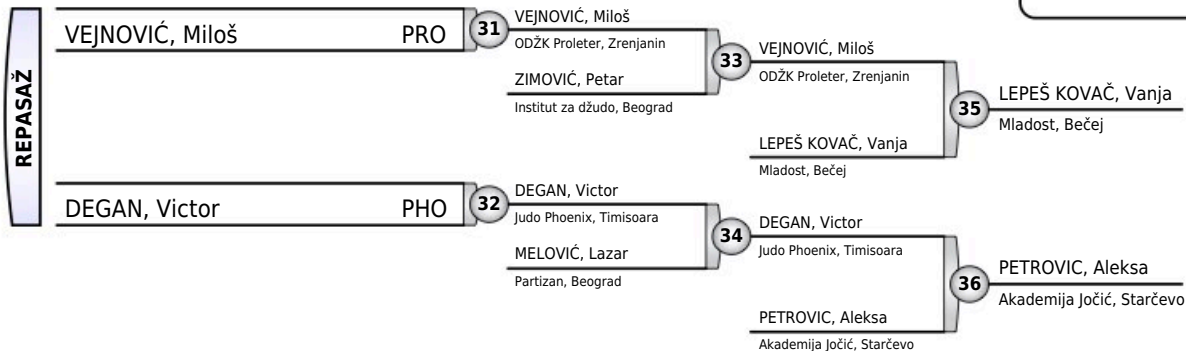



VLADAN PETROVIĆ I DAN

Beograd, 13.04.2024.

MLAĐI DEČACI

-38KG

20 takmičara

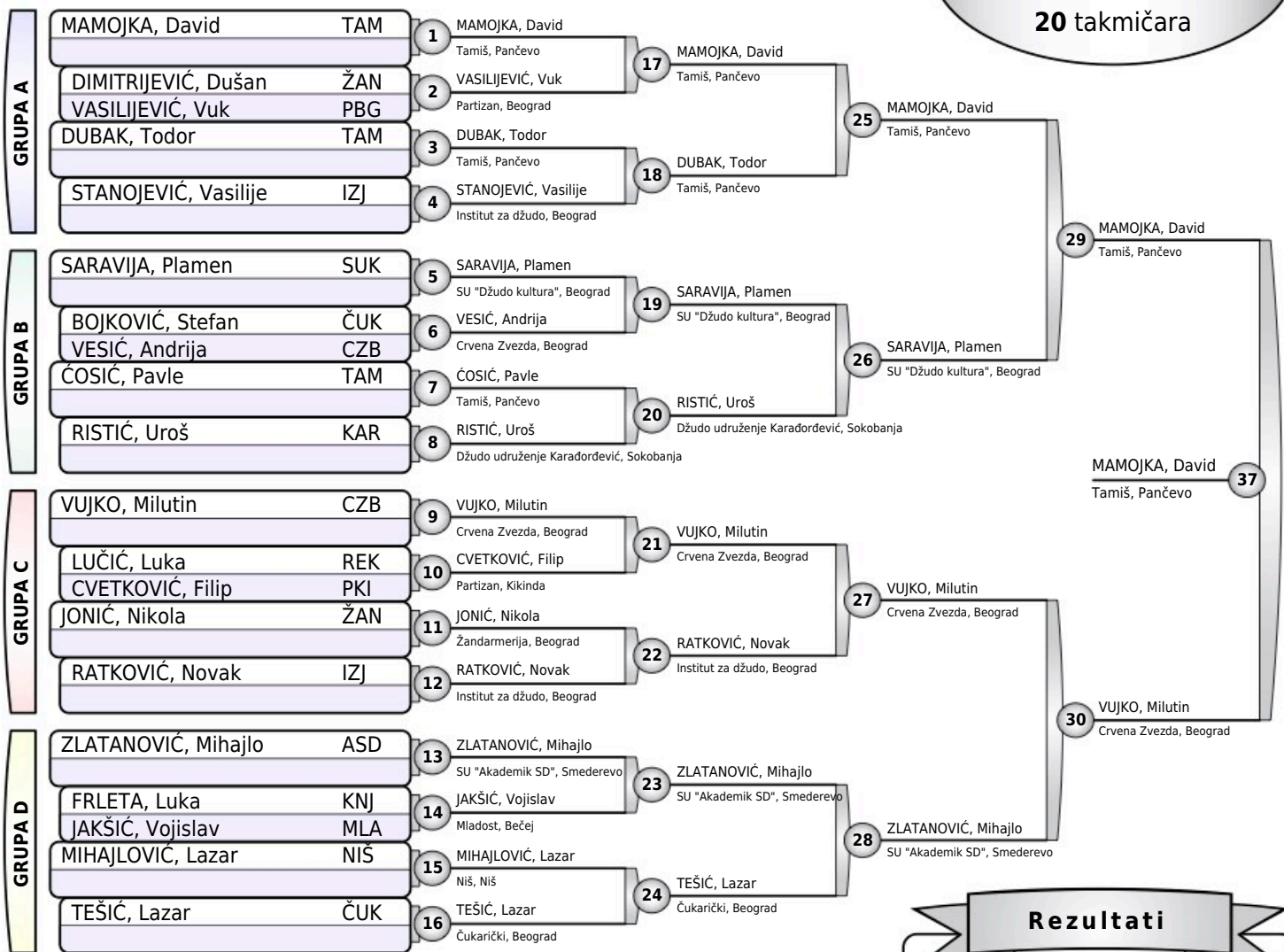

Rezultati

- MAMOJKA, David TAM
- VUJKO, Milutin CZB
- DUBAK, Todor TAM
- ZLATANOVIĆ, Mihajlo ASD
- SARAVIJA, Plamen SUK
- RATKOVIĆ, Novak IZJ
- VASILJEVIĆ, Vuk PBG
- CVETKOVIĆ, Filip PKI



VLADAN PETROVIĆ I DAN

Beograd, 13.04.2024.

MLAĐI DEČACI

-42KG

16 takmičara

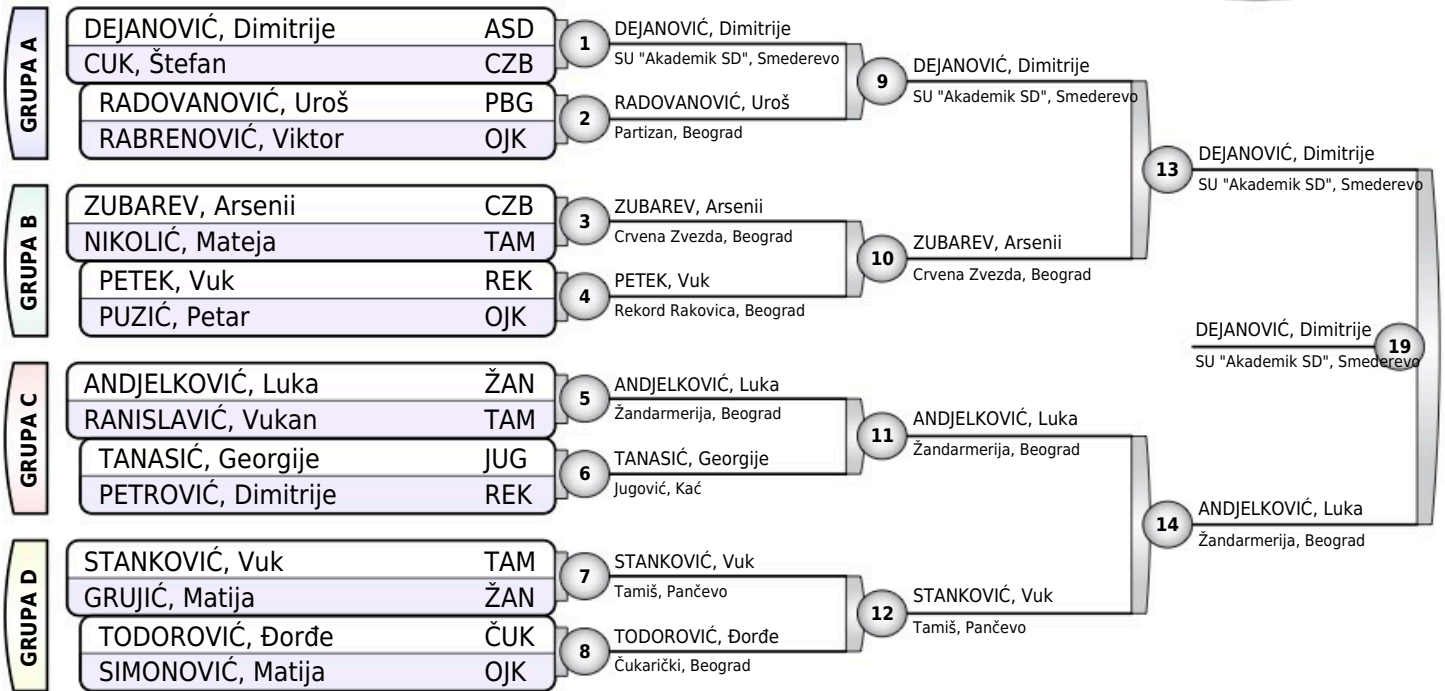

Rezultati

- | | | |
|----|----------------------|-----|
| 1. | DEJANOVIĆ, Dimitrije | ASD |
| 2. | ANDJELKOVIĆ, Luka | ŽAN |
| 3. | ZUBAREV, Arsenii | CZB |
| 3. | STANKOVIĆ, Vuk | TAM |
| 5. | RADOVANOVIĆ, Uroš | PBG |
| 5. | TANASIĆ, Georgije | JUG |
| 7. | CUK, Štefan | CZB |
| 7. | RANISLAVIĆ, Vukan | TAM |

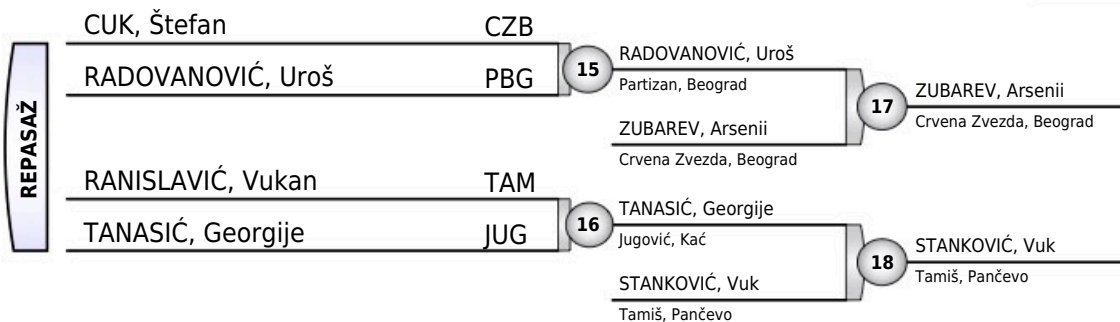



VLADAN PETROVIĆ I DAN

Beograd, 13.04.2024.

MLAĐI DEČACI

-46KG

23 takmičara

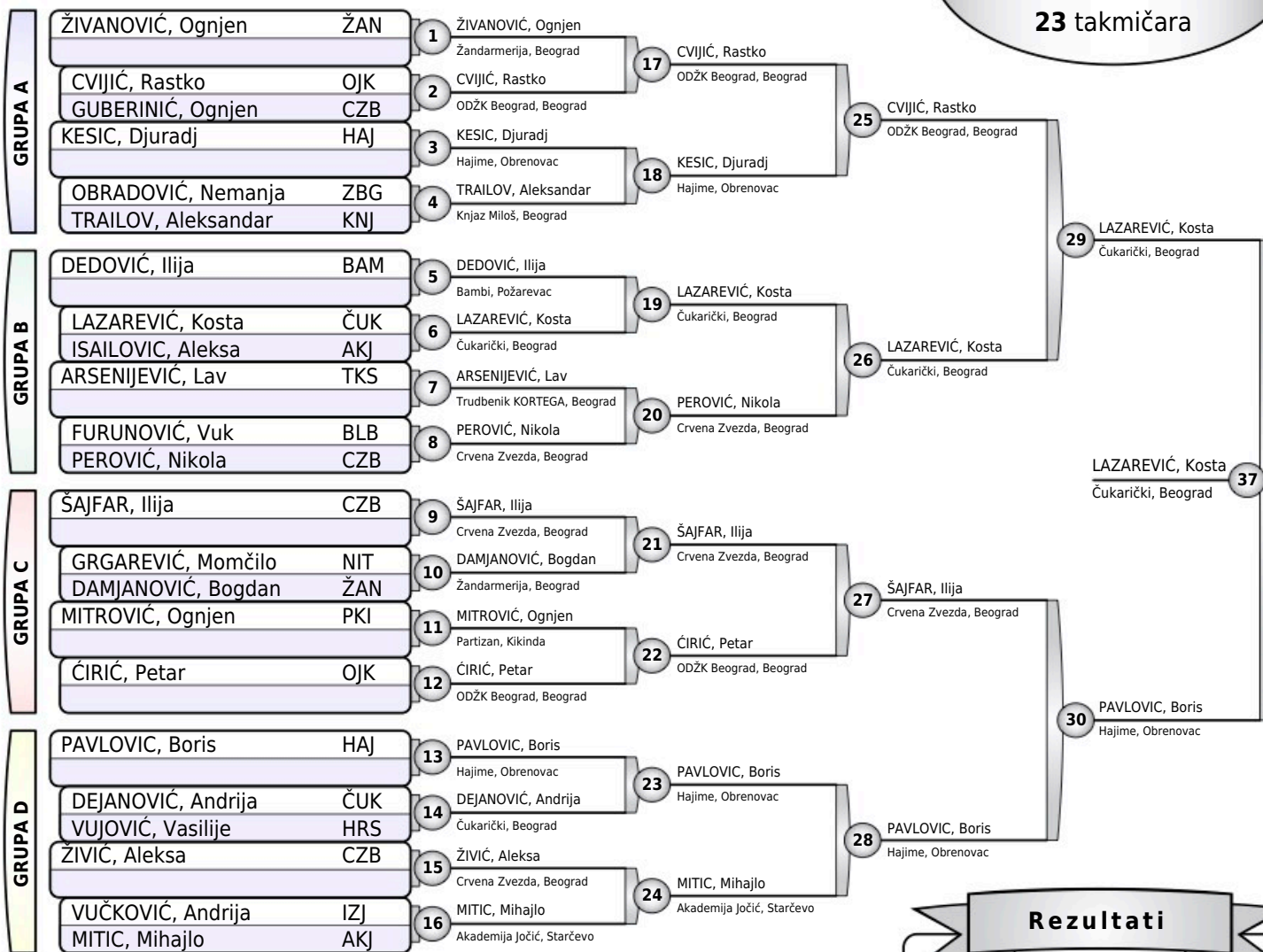

Rezultati

- LAZAREVIĆ, Kosta ČUK
- PAVLOVIC, Boris HAI
- CVJIJĆ, Rastko OJK
- ŠAJFAR, Ilija CZB
- PEROVIĆ, Nikola CZB
- DEJANOVIĆ, Andrija ČUK
- MITIC, Mihajlo AKJ
- ISAILOVIC, Aleksa AKJ



VLADAN PETROVIĆ I DAN

Beograd, 13.04.2024.

MLAĐI DEČACI

-50KG

17 takmičara

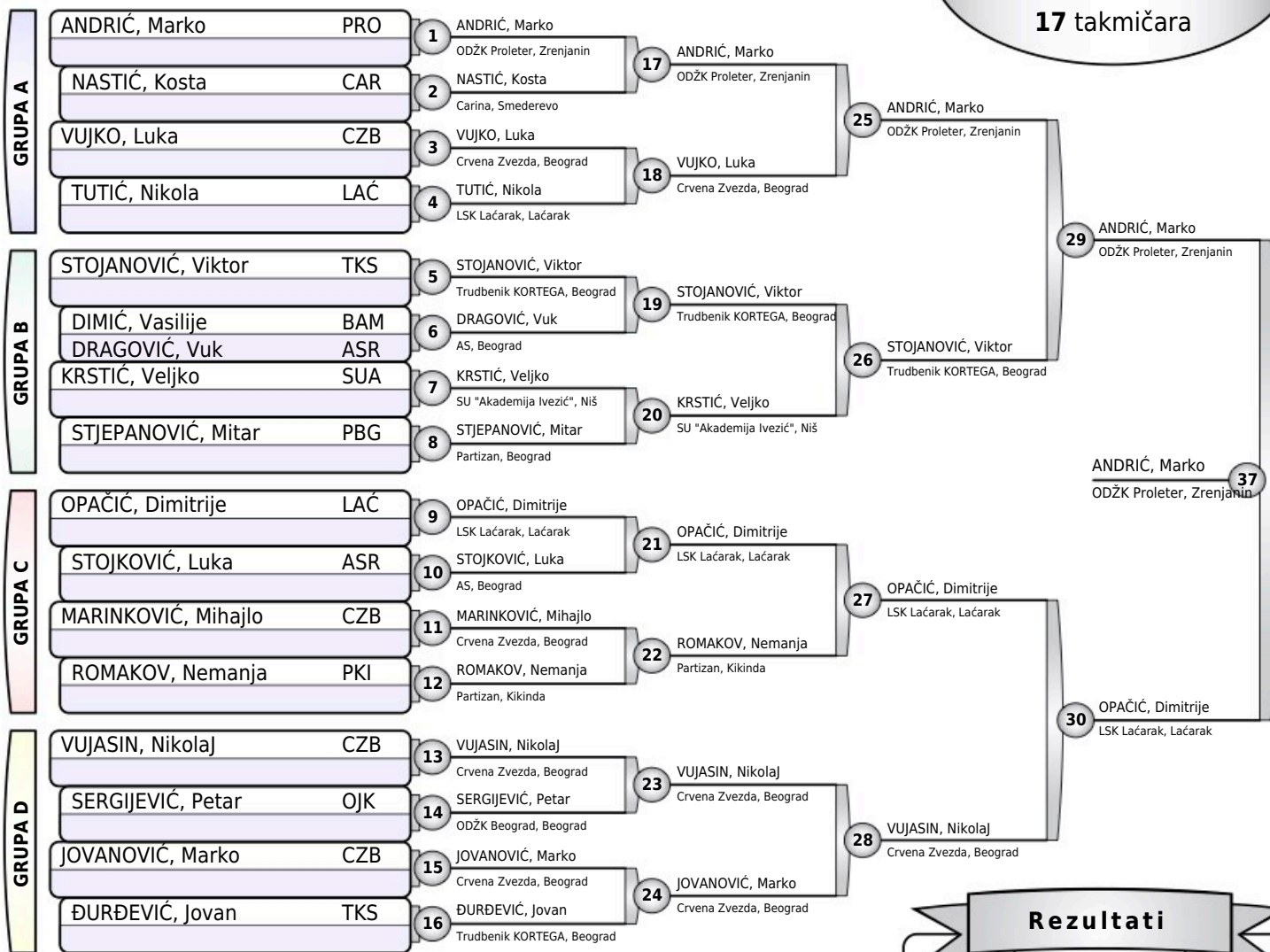

Rezultati

1. ANDRIĆ, Marko PRO
2. OPAČIĆ, Dimitrije LAĆ
3. STOJANOVIĆ, Viktor TKS
3. VUJASIN, Nikola CZB
5. VUJKO, Luka CZB
5. STOJKOVIĆ, Luka ASR
7. NASTIĆ, Kosta CAR
7. ROMAKOV, Nemanja PKI



VLADAN PETROVIĆ I DAN

Beograd, 13.04.2024.

MLAĐI DEČACI

-55KG

16 takmičara

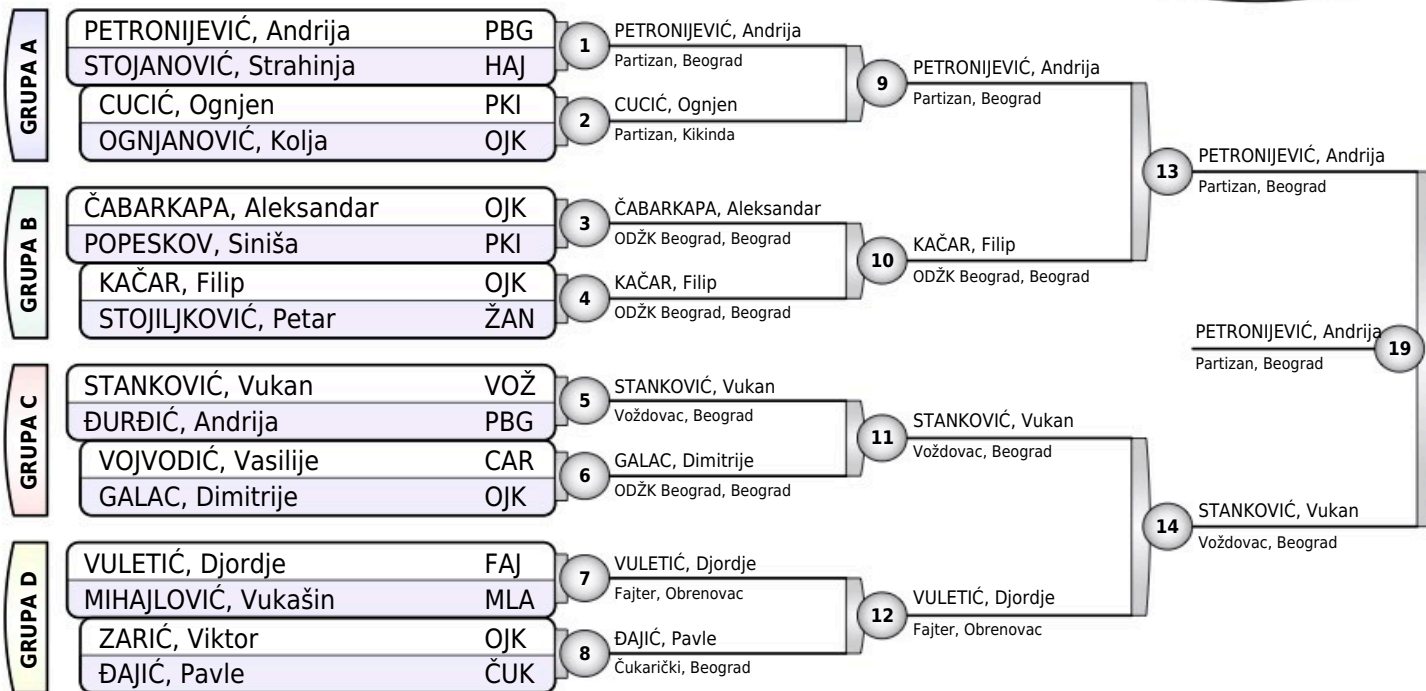

Rezultati

- PETRONIJEVIĆ, Andrija PBG
- STANKOVIĆ, Vukan VOŽ
- KAČAR, Filip OJK
- ĐURĐIĆ, Andrija PBG
- STOJANOVIĆ, Strahinja HAJ
- VULETIĆ, Djordje FAJ
- CUCIĆ, Ognjen PKI
- GALAC, Dimitrije OJK

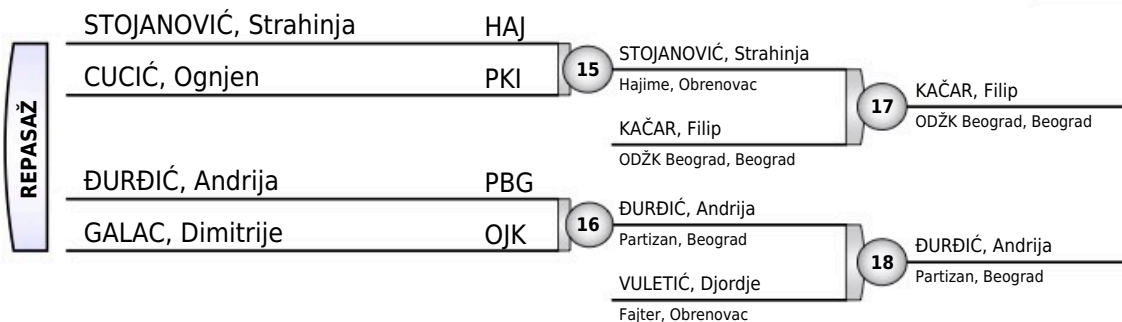



VLADAN PETROVIĆ I DAN

Beograd, 13.04.2024.

MLAĐI DEČACI

-60KG

11 takmičara

| GRUPA | Ime | Škola | Redni broj | Ime | Škola | Redni broj | Ime | Škola | Redni broj |
|---------|---------------------|-------|------------|---------------------|---|------------|----------------|-----------------------|------------|
| GRUPA A | NEŠOVIĆ, Lazar | ŽAN | 1 | NEŠOVIĆ, Lazar | Žandarmerija, Beograd | 9 | NEŠOVIĆ, Lazar | Žandarmerija, Beograd | 13 |
| | LAZAREVIĆ, Bogdan | BČA | 2 | LAZAREVIĆ, Bogdan | Borac, Čačak | 10 | NEŠOVIĆ, Lazar | Žandarmerija, Beograd | 19 |
| | RALEVIĆ, Stefan | CZB | 3 | LAZAREVIĆ, Bogdan | Borac, Čačak | 10 | MILAČIĆ, Luka | ODŽK Beograd, Beograd | 14 |
| GRUPA B | ALEKSIĆ, Andrej | OJK | 3 | ALEKSIĆ, Andrej | ODŽK Beograd, Beograd | 11 | MILAČIĆ, Luka | ODŽK Beograd, Beograd | 12 |
| | PANTIĆ, Strahinja | TAM | 4 | ĐURIĆ, Viktor | Crvena Zvezda, Beograd | 11 | MILAČIĆ, Luka | ODŽK Beograd, Beograd | 12 |
| | ĐURIĆ, Viktor | CZB | 4 | ĐURIĆ, Viktor | Crvena Zvezda, Beograd | 11 | MILAČIĆ, Luka | ODŽK Beograd, Beograd | 12 |
| GRUPA C | SMILJKIĆ, Milan | ŽAN | 5 | SMILJKIĆ, Milan | Žandarmerija, Beograd | 11 | MILAČIĆ, Luka | ODŽK Beograd, Beograd | 12 |
| | MILOVANOVIĆ, Nikola | HRS | 6 | MILOVANOVIĆ, Nikola | Hrabro srce, Beograd | 11 | MILAČIĆ, Luka | ODŽK Beograd, Beograd | 12 |
| GRUPA D | ALEKSIĆ, Dimitrije | KAR | 7 | ALEKSIĆ, Dimitrije | Džudo udruženje Karadordević, Sokobanja | 12 | MILAČIĆ, Luka | ODŽK Beograd, Beograd | 12 |
| | NUTA, Paul | PHO | 8 | MILAČIĆ, Luka | ODŽK Beograd, Beograd | 12 | MILAČIĆ, Luka | ODŽK Beograd, Beograd | 12 |
| | MILAČIĆ, Luka | OJK | 8 | MILAČIĆ, Luka | ODŽK Beograd, Beograd | 12 | MILAČIĆ, Luka | ODŽK Beograd, Beograd | 12 |

Rezultati

1. NEŠOVIĆ, Lazar ŽAN
2. MILAČIĆ, Luka OJK
3. LAZAREVIĆ, Bogdan BČA
3. SMILJKIĆ, Milan ŽAN
5. ĐURIĆ, Viktor CZB
5. ALEKSIĆ, Dimitrije KAR
7. NUTA, Paul PHO
- 7.

| | | | | | | | | | |
|---------|--------------------|-----|----|--------------------|---|----|-------------------|-----------------------|----|
| REPASAŽ | LAZAREVIĆ, Bogdan | BČA | 15 | LAZAREVIĆ, Bogdan | Borac, Čačak | 17 | LAZAREVIĆ, Bogdan | Borac, Čačak | 17 |
| | ĐURIĆ, Viktor | CZB | 16 | LAZAREVIĆ, Bogdan | Borac, Čačak | 17 | LAZAREVIĆ, Bogdan | Borac, Čačak | 17 |
| | NUTA, Paul | PHO | 16 | LAZAREVIĆ, Bogdan | Borac, Čačak | 17 | LAZAREVIĆ, Bogdan | Borac, Čačak | 17 |
| REPASAŽ | ALEKSIĆ, Dimitrije | KAR | 16 | ALEKSIĆ, Dimitrije | Džudo udruženje Karadordević, Sokobanja | 18 | SMILJKIĆ, Milan | Žandarmerija, Beograd | 18 |
| | SMILJKIĆ, Milan | ŽAN | 18 | SMILJKIĆ, Milan | Žandarmerija, Beograd | 18 | SMILJKIĆ, Milan | Žandarmerija, Beograd | 18 |



VLADAN PETROVIĆ I DAN

Beograd, 13.04.2024.

MLAĐI DEČACI

-66KG

3 takmičara

| TAKMIČAR I KLUB | 1 | 2 | 3 | POBEDA | BODOVA | MESTO |
|--|---|----|----|--------|--------|-------|
| 1 TICA, Lazar Crvena Zvezda, Beograd | | 10 | 10 | 2 | 20 | 1 |
| 2 LONČAR, Marko Jugović, Kač | 0 | | 0 | 0 | 0 | 3 |
| 3 GLADIĆ, Ivan ODŽK Proleter, Zrenjanin | 0 | 10 | | 1 | 10 | 2 |

| | | | |
|---------------|-----|---|--------------------------|
| TICA, Lazar | CZB | 1 | TICA, Lazar |
| LONČAR, Marko | JUG | | Crvena Zvezda, Beograd |
| TICA, Lazar | CZB | 2 | TICA, Lazar |
| GLADIĆ, Ivan | PRO | | Crvena Zvezda, Beograd |
| LONČAR, Marko | JUG | 3 | GLADIĆ, Ivan |
| GLADIĆ, Ivan | PRO | | ODŽK Proleter, Zrenjanin |

Rezultati

- | | |
|------------------|-----|
| 1. TICA, Lazar | CZB |
| 2. GLADIĆ, Ivan | PRO |
| 3. LONČAR, Marko | JUG |



VLADAN PETROVIĆ I DAN

Beograd, 13.04.2024.

MLAĐI DEČACI

+66KG

8 takmičara

| | | | | | | | |
|---------|---|--------------------------|-----|---|-------------------------------|----|-------------------------------|
| GRUPA A | 1 | AĐANČIĆ, Luka | REK | 1 | AĐANČIĆ, Luka | 9 | AĐANČIĆ, Luka |
| | | | | | Rekord Rakovica, Beograd | | Rekord Rakovica, Beograd |
| | 2 | TURKOVIĆ, Viktor | VOŽ | 2 | TURKOVIĆ, Viktor | | |
| | | | | | Voždovac, Beograd | | |
| GRUPA B | 3 | KOVAČEVIĆ, Vanja | CZB | 3 | KOVAČEVIĆ, Vanja | 10 | KOVAČEVIĆ, Vanja |
| | | | | | Crvena Zvezda, Beograd | | Crvena Zvezda, Beograd |
| | 4 | ŠOLEVIĆ, Vasilije | NBG | 4 | ŠOLEVIĆ, Vasilije | | |
| | | | | | Novi Beograd, Beograd | | |
| GRUPA C | 5 | JELIĆ, Aleksa | BČA | 5 | JELIĆ, Aleksa | 11 | JELIĆ, Aleksa |
| | | | | | Borac, Čačak | | Borac, Čačak |
| | 6 | DIMIĆ, Martin | KNJ | 6 | DIMIĆ, Martin | | |
| | | | | | Knjaz Miloš, Beograd | | |
| GRUPA D | 7 | ĐAKOVIĆ, Dušan | REK | 7 | ĐAKOVIĆ, Dušan | 12 | HANGYASI, Csongor botond |
| | | | | | Rekord Rakovica, Beograd | | Hód Judo SE, Hódmezővásárhely |
| | 8 | HANGYASI, Csongor botond | HJS | 8 | HANGYASI, Csongor botond | | |
| | | | | | Hód Judo SE, Hódmezővásárhely | | |

Rezultati

1. AĐANČIĆ, Luka REK
2. HANGYASI, Csongor botond HJS
3. TURKOVIĆ, Viktor VOŽ
3. JELIĆ, Aleksa BČA
5. KOVAČEVIĆ, Vanja CZB
5. ĐAKOVIĆ, Dušan REK
- 7.
- 7.

| | | | | | | | |
|---------|----|------------------|-----|----|--------------------------|----|-------------------|
| REPASAŽ | 15 | TURKOVIĆ, Viktor | VOŽ | 15 | TURKOVIĆ, Viktor | 17 | TURKOVIĆ, Viktor |
| | | | | | Voždovac, Beograd | | Voždovac, Beograd |
| | | | | | KOVAČEVIĆ, Vanja | | |
| | | | | | Crvena Zvezda, Beograd | | |
| | 16 | ĐAKOVIĆ, Dušan | REK | 16 | ĐAKOVIĆ, Dušan | 18 | JELIĆ, Aleksa |
| | | | | | Rekord Rakovica, Beograd | | Borac, Čačak |
| | | | | | JELIĆ, Aleksa | | |
| | | | | | Borac, Čačak | | |



VLADAN PETROVIĆ I DAN

Beograd, 13.04.2024.

MLAĐE DEVOJČICE

-32KG

7 takmičarki

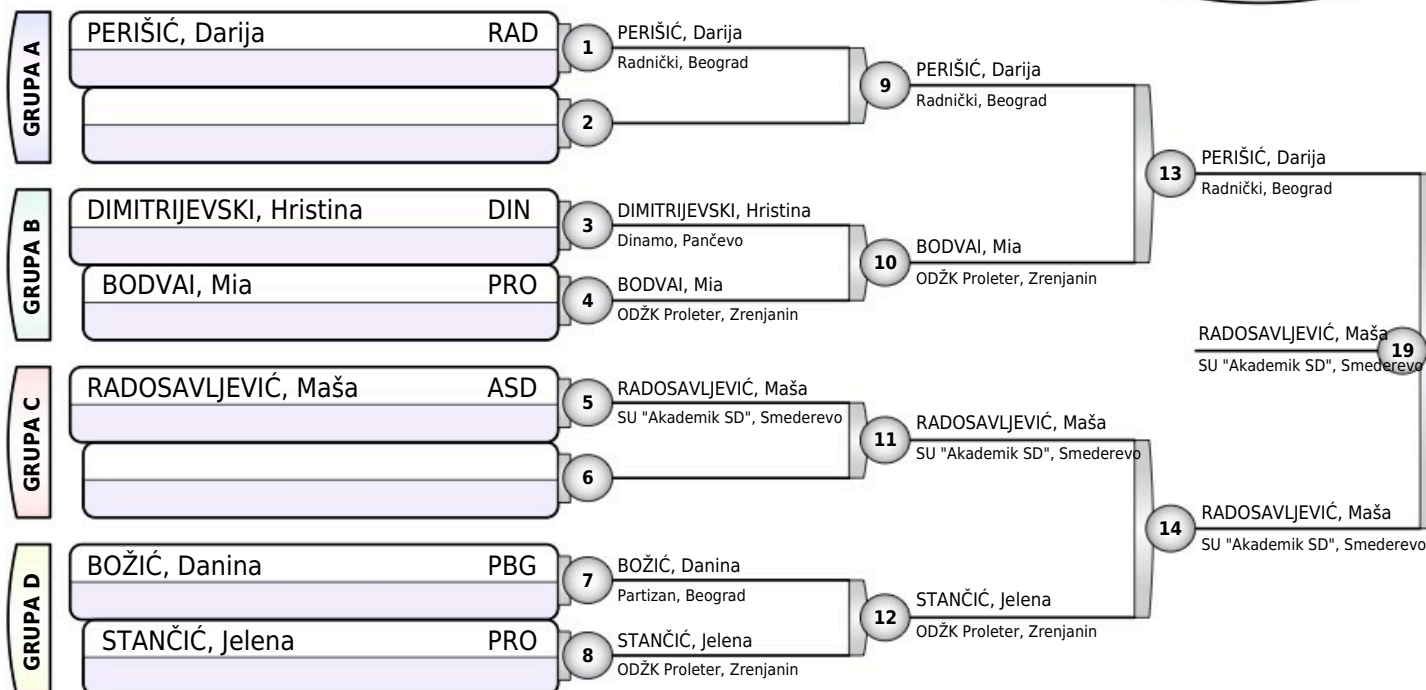

Rezultati

1. RADOSAVLJEVIĆ, Maša ASD
2. PERIŠIĆ, Darija RAD
3. BODVAI, Mia PRO
3. STANČIĆ, Jelena PRO
- 5.
- 5.
- 7.
- 7.



VLADAN PETROVIĆ I DAN

Beograd, 13.04.2024.

MLAĐE DEVOJČICE

-36KG

8 takmičarki

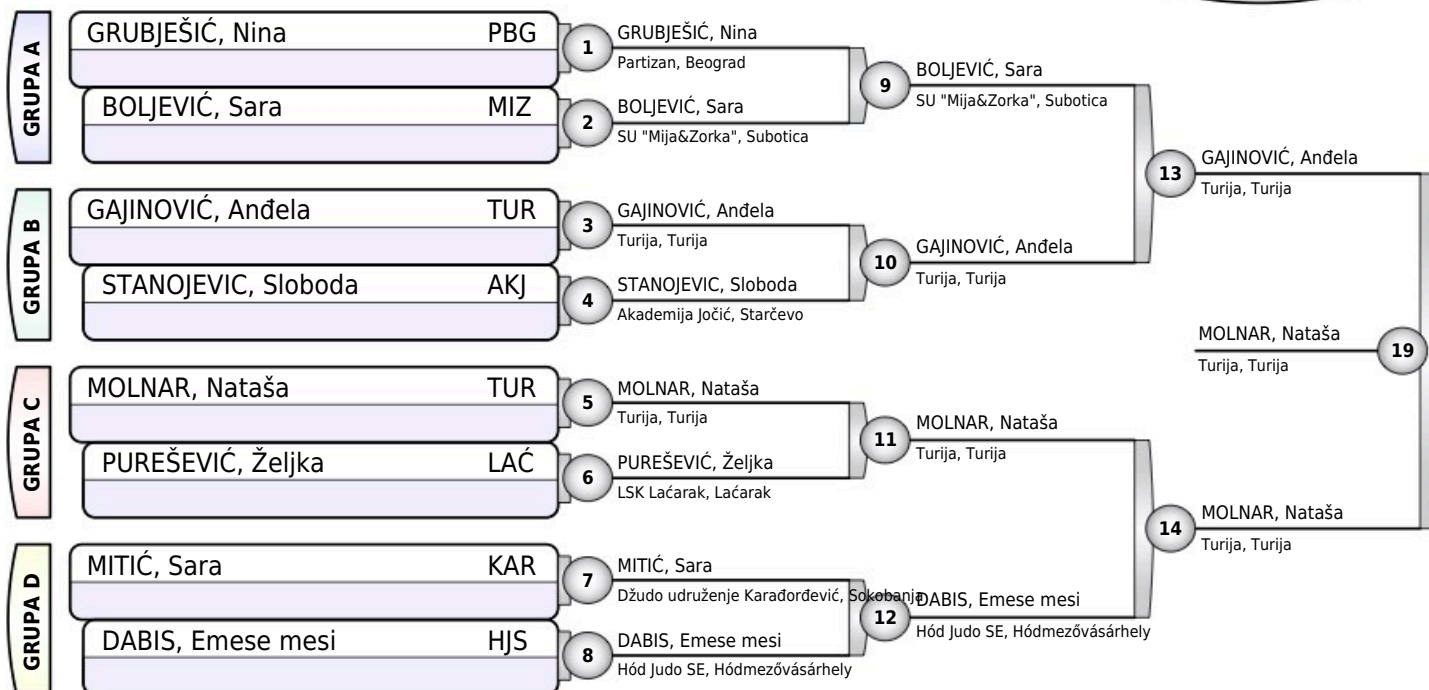

Rezultati

1. MOLNAR, Nataša TUR
2. GAJINOVIĆ, Anđela TUR
3. BOLJEVIĆ, Sara MIZ
3. PUREŠEVIĆ, Željka LAĆ
5. STANOJEVIC, Sloboda AKJ
5. DABIS, Emese mesi HJS
- 7.
- 7.

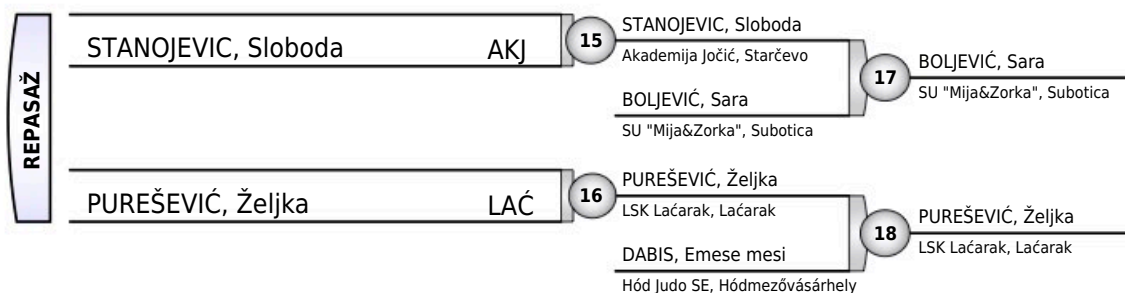



VLADAN PETROVIĆ I DAN

Beograd, 13.04.2024.

MLAĐE DEVOJČICE

-40KG

11 takmičarki

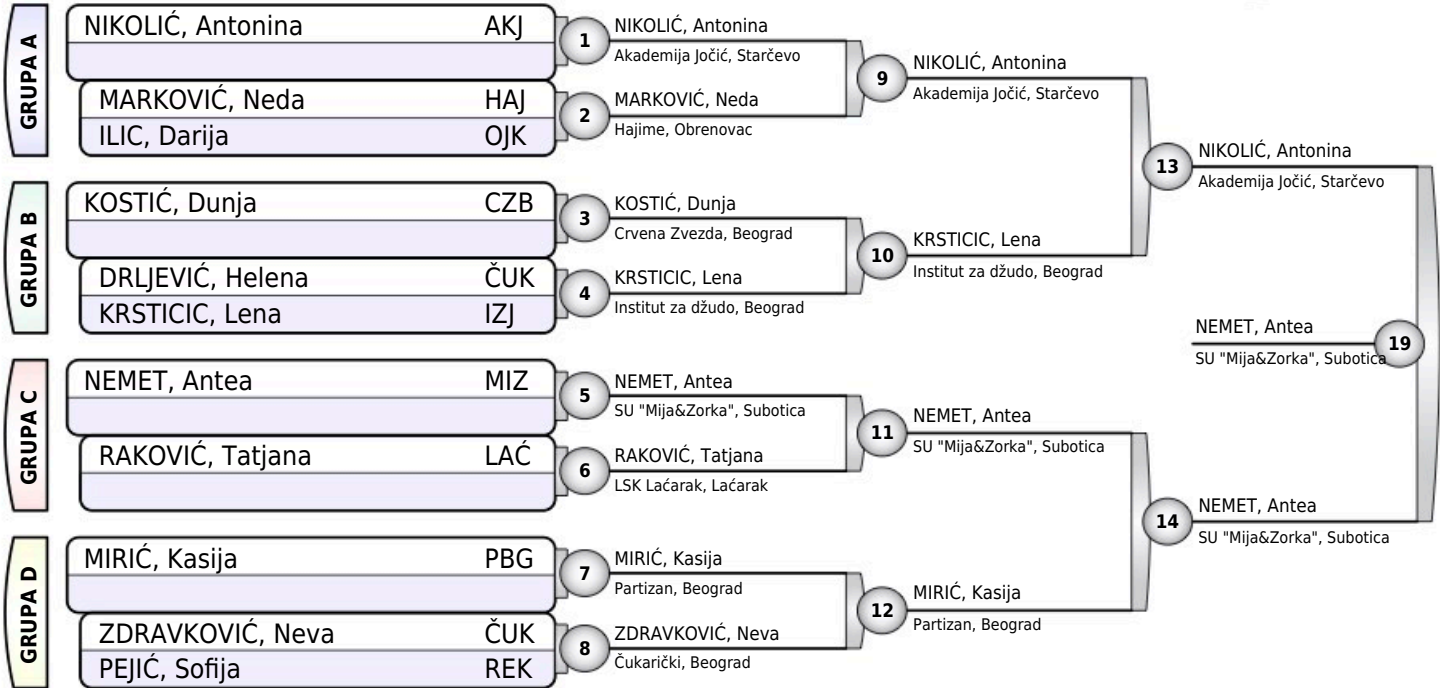

Rezultati

1. NEMET, Antea MIZ
2. NIKOLIĆ, Antonina AKJ
3. MARKOVIĆ, Neda HAJ
3. MIRIĆ, Kasija PBG
5. KRSTICIC, Lena IZJ
5. RAKOVIĆ, Tatjana LAĆ
- 7.
- 7.

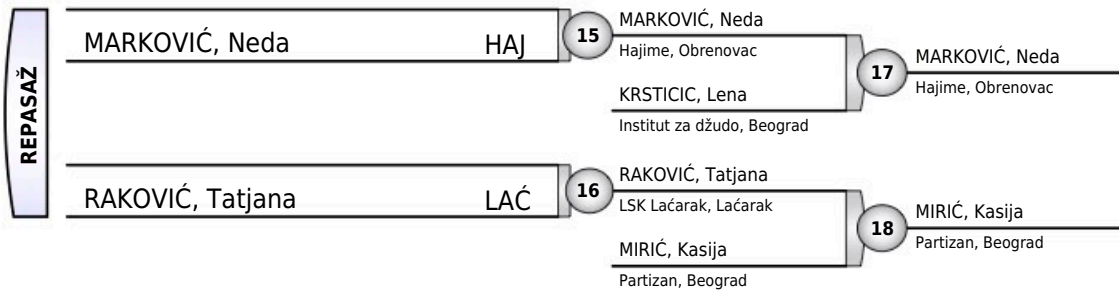



VLADAN PETROVIĆ I DAN

Beograd, 13.04.2024.

MLAĐE DEVOJČICE

-44KG

9 takmičarki

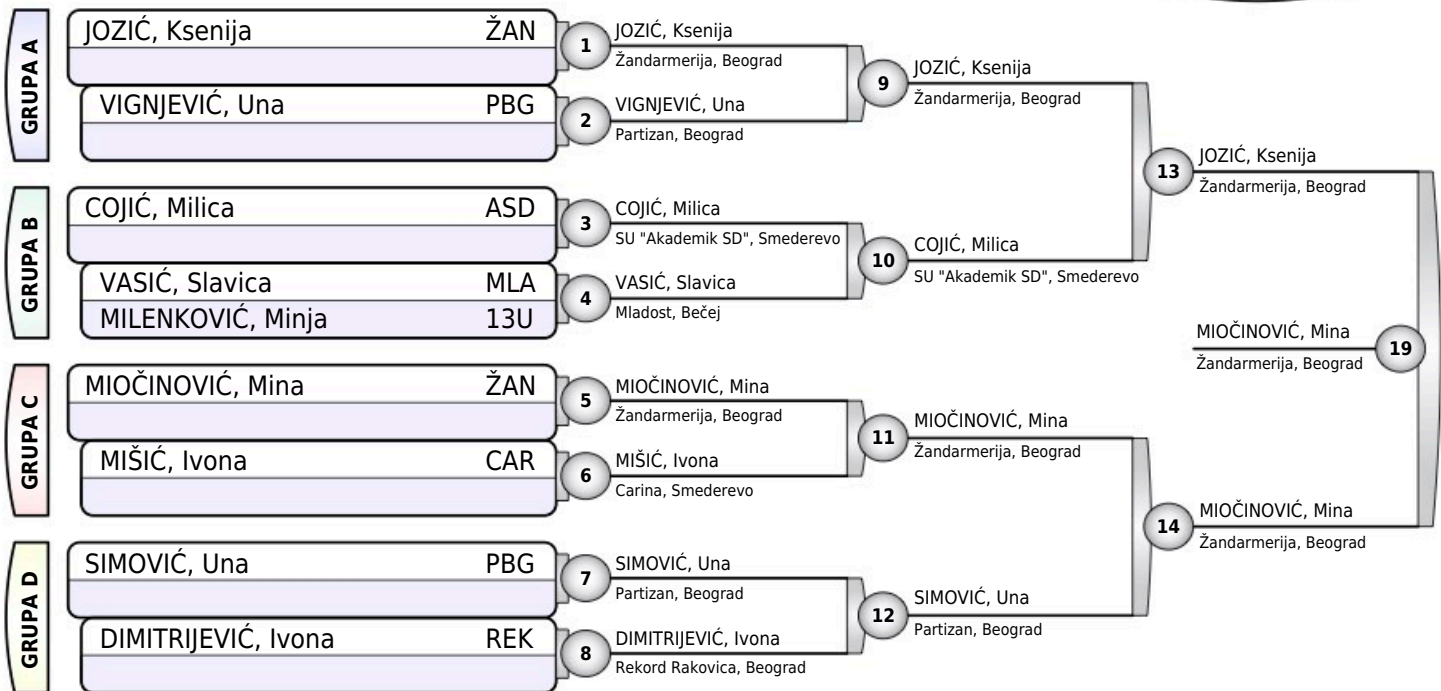

Rezultati

1. MIOČINOVIĆ, Mina ŽAN
2. JOZIĆ, Ksenija ŽAN
3. COJIĆ, Milica ASD
3. SIMOVIĆ, Una PBG
5. VIGNJEVIĆ, Una PBG
5. MIŠIĆ, Ivona CAR
- 7.
- 7.





VLADAN PETROVIĆ I DAN

Beograd, 13.04.2024.

MLAĐE DEVOJČICE

-48KG

9 takmičarki

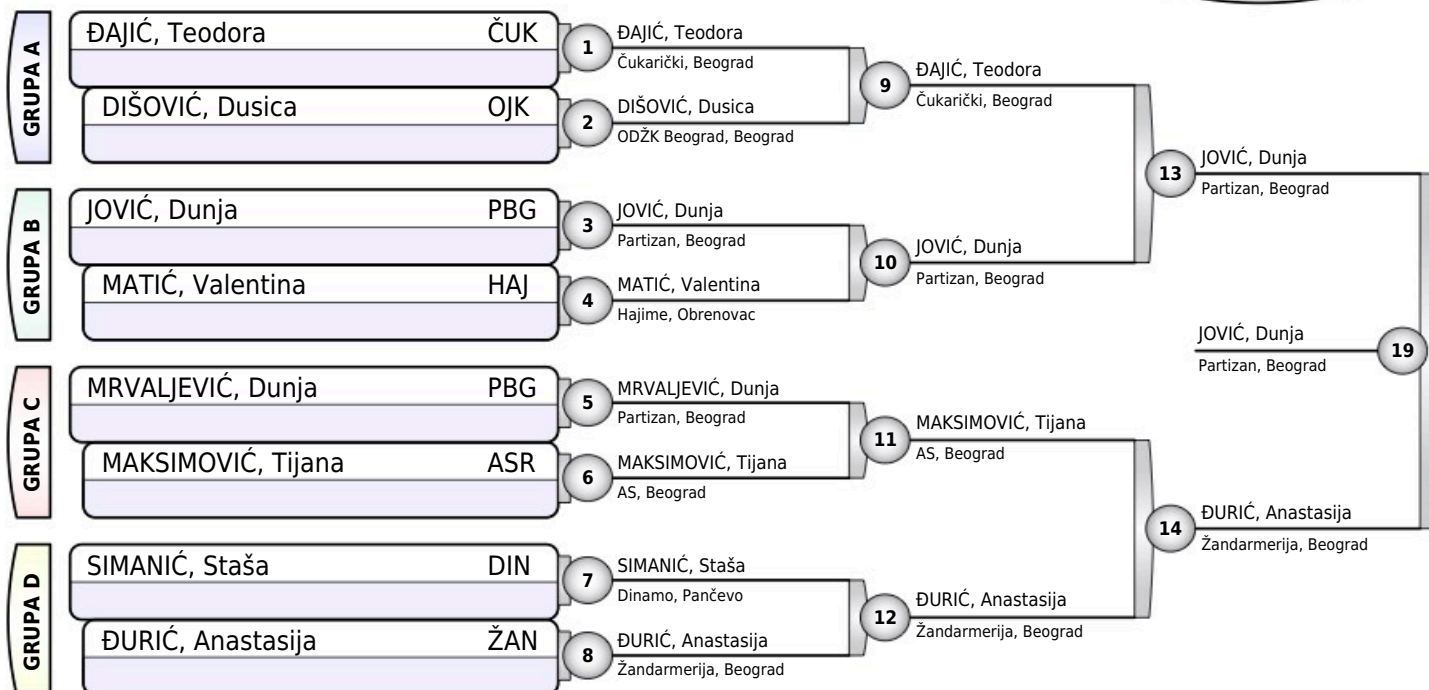

Rezultati

1. JOVIĆ, Dunja PBG
2. ĐURIĆ, Anastasija ŽAN
3. MATIĆ, Valentina HAJ
3. SIMANIĆ, Staša DIN
5. ĐAJIĆ, Teodora ČUK
5. MAKSIMOVIĆ, Tijana ASR
- 7.
- 7.

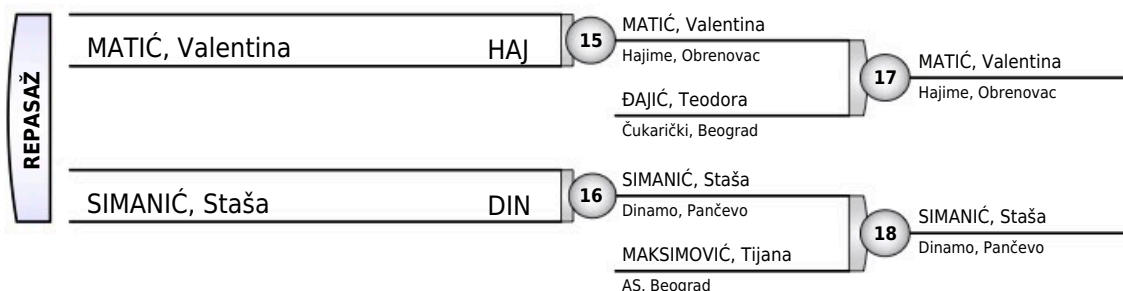



VLADAN PETROVIĆ I DAN

Beograd, 13.04.2024.

MLAĐE DEVOJČICE

-52KG

4 takmičarki

| TAKMIČAR I KLUB | 1 | 2 | 3 | 4 | POBEDA | BODOVA | MESTO |
|---|----|----|----|---|--------|--------|-------|
| 1 PETROVIĆ, Martina Rekord Rakovica, Beograd | | 0 | 0 | 0 | 0 | 0 | 3 |
| 2 PANTELIĆ, Lena Fajter, Obrenovac | 10 | | 10 | 0 | 2 | 20 | 2 |
| 3 ALEKSIĆ, Jana Novi Beograd, Beograd | 10 | 0 | | 0 | 1 | 10 | 3 |
| 4 ŠAROVIĆ, Emilija Crvena Zvezda, Beograd | 10 | 10 | 10 | | 3 | 30 | 1 |

| | | | |
|-------------------|-----|---|------------------------|
| PETROVIĆ, Martina | REK | 1 | PANTELIĆ, Lena |
| PANTELIĆ, Lena | FAJ | | Fajter, Obrenovac |
| ALEKSIĆ, Jana | NBG | 2 | ŠAROVIĆ, Emilija |
| ŠAROVIĆ, Emilija | CZB | | Crvena Zvezda, Beograd |
| PETROVIĆ, Martina | REK | 3 | ALEKSIĆ, Jana |
| ALEKSIĆ, Jana | NBG | | Novi Beograd, Beograd |
| PANTELIĆ, Lena | FAJ | 4 | ŠAROVIĆ, Emilija |
| ŠAROVIĆ, Emilija | CZB | | Crvena Zvezda, Beograd |
| PETROVIĆ, Martina | REK | 5 | ŠAROVIĆ, Emilija |
| ŠAROVIĆ, Emilija | CZB | | Crvena Zvezda, Beograd |
| PANTELIĆ, Lena | FAJ | 6 | PANTELIĆ, Lena |
| ALEKSIĆ, Jana | NBG | | Fajter, Obrenovac |

Rezultati

1. ŠAROVIĆ, Emilija CZB
2. PANTELIĆ, Lena FAJ
3. ALEKSIĆ, Jana NBG
3. PETROVIĆ, Martina REK



VLADAN PETROVIĆ I DAN

Beograd, 13.04.2024.

MLAĐE DEVOJČICE

-56KG

3 takmičarke

| TAKMIČAR I KLUB | 1 | 2 | 3 | POBEDA | BODOVA | MESTO |
|--|---|----|----|--------|--------|-------|
| 1 GAŠIĆ, Lena ODŽK Beograd, Beograd | | 10 | 10 | 2 | 20 | 1 |
| 2 TODOROVIĆ, Hristina SU Fudži, Beograd | 0 | | 0 | 0 | 0 | 3 |
| 3 BANĐUR, Sofija SU Fudži, Beograd | 0 | 10 | | 1 | 10 | 2 |

| | | | |
|---------------------|-----|---|-----------------------|
| GAŠIĆ, Lena | OJK | 1 | GAŠIĆ, Lena |
| TODOROVIĆ, Hristina | FDŽ | | ODŽK Beograd, Beograd |
| GAŠIĆ, Lena | OJK | 2 | GAŠIĆ, Lena |
| BANĐUR, Sofija | FDŽ | | ODŽK Beograd, Beograd |
| TODOROVIĆ, Hristina | FDŽ | 3 | BANĐUR, Sofija |
| BANĐUR, Sofija | FDŽ | | SU Fudži, Beograd |

Rezultati

- GAŠIĆ, Lena OJK
- BANĐUR, Sofija FDŽ
- TODOROVIĆ, Hristina FDŽ



VLADAN PETROVIĆ I DAN

Beograd, 13.04.2024.

MLAĐE DEVOJČICE

+56KG

8 takmičarki

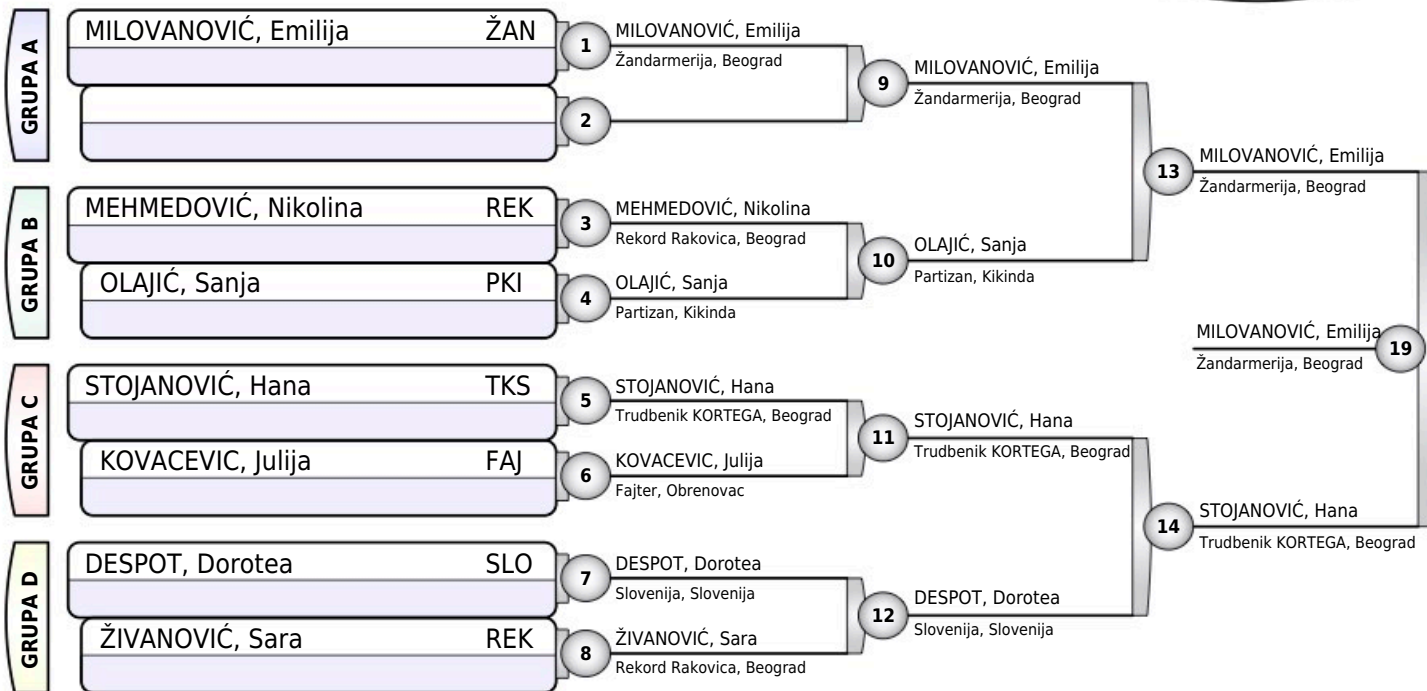

Rezultati

1. MILOVANOVIĆ, Emilija ŽAN
2. STOJANOVIĆ, Hana TKS
3. OLAJIĆ, Sanja PKI
3. KOVACEVIC, Julija FAJ
5. DESPOT, Dorotea SLO
- 5.
- 7.
- 7.

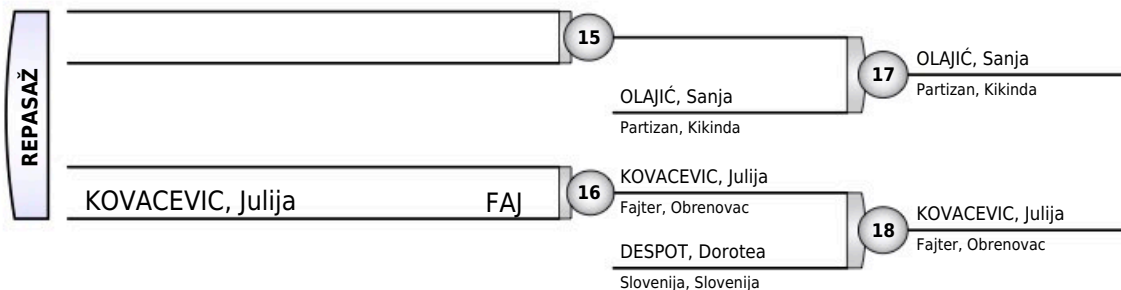



VLADAN PETROVIĆ I DAN

Beograd, 13.04.2024.

MLAĐI KADETI

-46KG

3 takmičara

| TAKMIČAR I KLUB | 1 | 2 | 3 | POBEDA | BODOVA | MESTO |
|--|----|----|---|--------|--------|-------|
| 1 NIČIĆ, Nemanja SU "Mija&Zorka", Subotica | | 10 | 0 | 1 | 10 | 2 |
| 2 GRUJIĆ, Matija Knjaz Miloš, Beograd | 0 | | 0 | 0 | 0 | 3 |
| 3 ARSENIJEVIĆ, Vuk Trudbenik KORTEGA, Beograd | 10 | 10 | | 2 | 20 | 1 |

| | | | |
|------------------|-----|---|----------------------------|
| NIČIĆ, Nemanja | MIZ | 1 | NIČIĆ, Nemanja |
| GRUJIĆ, Matija | KNJ | | SU "Mija&Zorka", Subotica |
| NIČIĆ, Nemanja | MIZ | 2 | ARSENIJEVIĆ, Vuk |
| ARSENIJEVIĆ, Vuk | TKS | | Trudbenik KORTEGA, Beograd |
| GRUJIĆ, Matija | KNJ | 3 | ARSENIJEVIĆ, Vuk |
| ARSENIJEVIĆ, Vuk | TKS | | Trudbenik KORTEGA, Beograd |

Rezultati

1. ARSENIJEVIĆ, Vuk TKS
2. NIČIĆ, Nemanja MIZ
3. GRUJIĆ, Matija KNJ



VLADAN PETROVIĆ I DAN

Beograd, 13.04.2024.

MLAĐI KADETI

-50KG

5 takmičara

| TAKMIČAR I KLUB | 1 | 2 | 3 | 4 | 5 | POBEDA | BODOVA | MESTO |
|---|---|----|----|----|----|--------|--------|-------|
| 1 DANGUBIĆ, Luka Crvena Zvezda, Beograd | | 10 | 10 | 1 | 10 | 4 | 31 | 1 |
| 2 KOSTIĆ, Ognjen SU "Akademik SD", Smederevo | 0 | | 10 | 10 | 10 | 3 | 30 | 2 |
| 3 NEMET, Matej SU "Mija&Zorka", Subotica | 0 | 0 | | 0 | 10 | 1 | 10 | 3 |
| 4 STANKOVIĆ, Sergej Partizan, Beograd | 0 | 0 | 10 | | 10 | 2 | 20 | 3 |
| 5 IVANOVIĆ, Branko Voždovac, Beograd | 0 | 0 | 0 | 0 | | 0 | 0 | 5 |

| | | | |
|-------------------|-----|----|-----------------------------|
| DANGUBIĆ, Luka | CZB | 1 | DANGUBIĆ, Luka |
| KOSTIĆ, Ognjen | ASD | | Crvena Zvezda, Beograd |
| NEMET, Matej | MIZ | 2 | STANKOVIĆ, Sergej |
| STANKOVIĆ, Sergej | PBG | | Partizan, Beograd |
| DANGUBIĆ, Luka | CZB | 3 | DANGUBIĆ, Luka |
| IVANOVIĆ, Branko | VOŽ | | Crvena Zvezda, Beograd |
| KOSTIĆ, Ognjen | ASD | 4 | KOSTIĆ, Ognjen |
| NEMET, Matej | MIZ | | SU "Akademik SD", Smederevo |
| STANKOVIĆ, Sergej | PBG | 5 | STANKOVIĆ, Sergej |
| IVANOVIĆ, Branko | VOŽ | | Partizan, Beograd |
| DANGUBIĆ, Luka | CZB | 6 | DANGUBIĆ, Luka |
| NEMET, Matej | MIZ | | Crvena Zvezda, Beograd |
| KOSTIĆ, Ognjen | ASD | 7 | KOSTIĆ, Ognjen |
| STANKOVIĆ, Sergej | PBG | | SU "Akademik SD", Smederevo |
| NEMET, Matej | MIZ | 8 | NEMET, Matej |
| IVANOVIĆ, Branko | VOŽ | | SU "Mija&Zorka", Subotica |
| DANGUBIĆ, Luka | CZB | 9 | DANGUBIĆ, Luka |
| STANKOVIĆ, Sergej | PBG | | Crvena Zvezda, Beograd |
| KOSTIĆ, Ognjen | ASD | 10 | KOSTIĆ, Ognjen |
| IVANOVIĆ, Branko | VOŽ | | SU "Akademik SD", Smederevo |

Rezultati

1. DANGUBIĆ, Luka CZB
2. KOSTIĆ, Ognjen ASD
3. STANKOVIĆ, Sergej PBG
3. NEMET, Matej MIZ
5. IVANOVIĆ, Branko VOŽ



VLADAN PETROVIĆ I DAN

Beograd, 13.04.2024.

MLAĐI KADETI

-55KG

7 takmičara

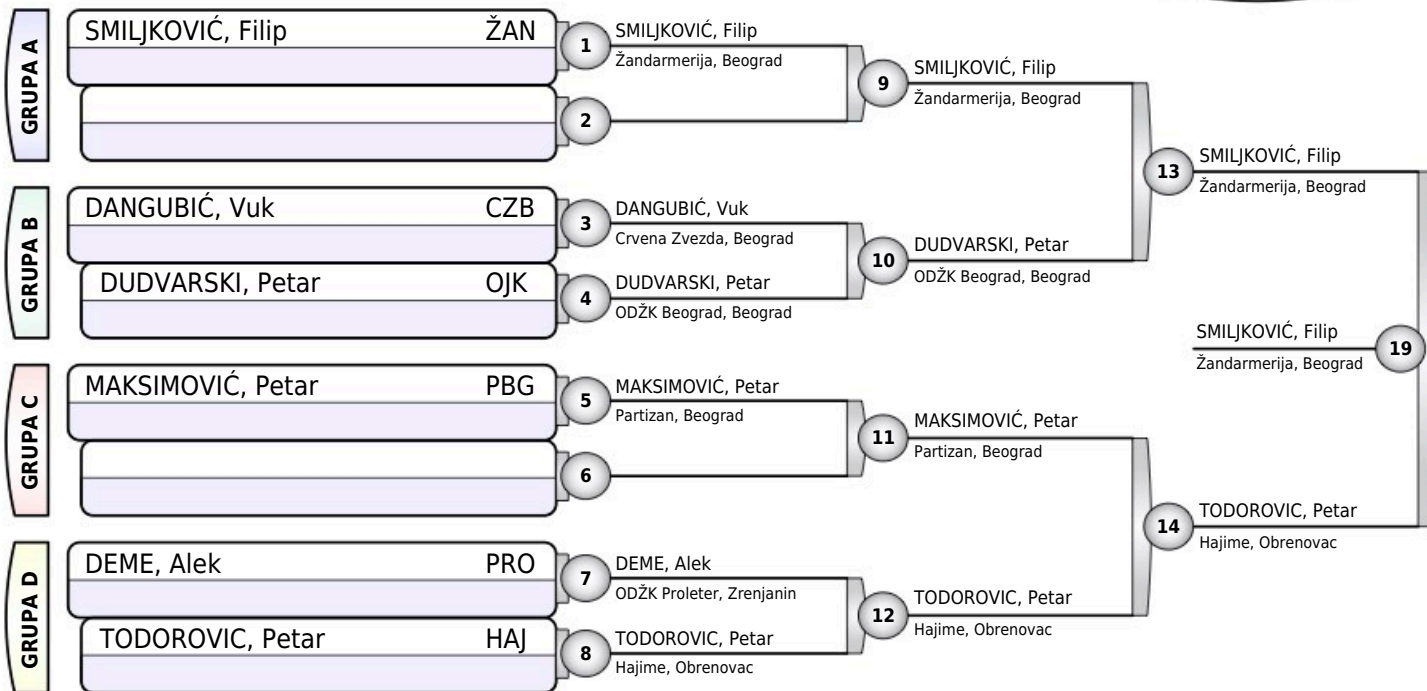

Rezultati

1. SMILJKOVIĆ, Filip ŽAN
2. TODOROVIC, Petar HAJ
3. DUDVARSKI, Petar OJK
3. DEME, Alek PRO
5. MAKSIMOVIĆ, Petar PBG
- 5.
- 7.
- 7.

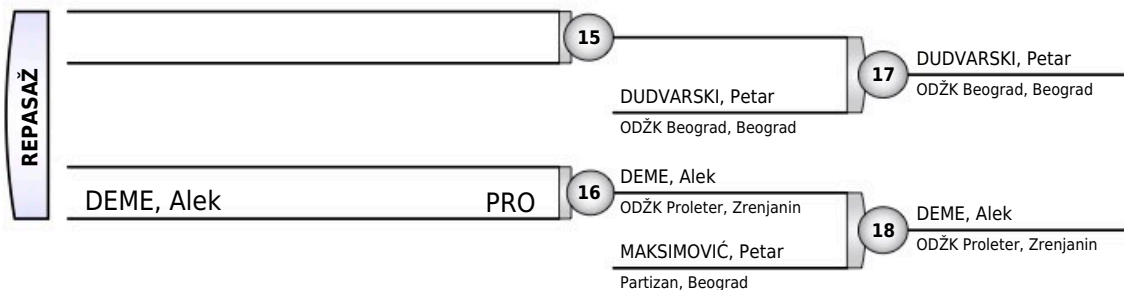



VLADAN PETROVIĆ I DAN

Beograd, 13.04.2024.

MLAĐI KADETI

-60KG

5 takmičara

| TAKMIČAR I KLUB | 1 | 2 | 3 | 4 | 5 | POBEDA | BODOVA | MESTO |
|---|---|---|----|----|----|--------|--------|-------|
| 1 JELIĆ, Nikola 13. maj, Ub | | 0 | 10 | 10 | 10 | 3 | 30 | 2 |
| 2 PETROVIĆ, Nenad ODŽK Beograd, Beograd | 1 | | 10 | 10 | 10 | 4 | 31 | 1 |
| 3 NOVKOVIĆ, Nenad Zmaj, Srpski Krstur | 0 | 0 | | 10 | 10 | 2 | 20 | 3 |
| 4 COJIĆ, Lazar SU "Akademik SD", Smederevo | 0 | 0 | 0 | | 0 | 0 | 0 | 5 |
| 5 PAVLOVIĆ, Rade ODŽK Beograd, Beograd | 0 | 0 | 0 | 10 | | 1 | 10 | 3 |

| | | | |
|-----------------|-----|----|-----------------------|
| JELIĆ, Nikola | 13U | 1 | PETROVIĆ, Nenad |
| PETROVIĆ, Nenad | OJK | | ODŽK Beograd, Beograd |
| NOVKOVIĆ, Nenad | ZMA | 2 | NOVKOVIĆ, Nenad |
| COJIĆ, Lazar | ASD | | Zmaj, Srpski Krstur |
| JELIĆ, Nikola | 13U | 3 | JELIĆ, Nikola |
| PAVLOVIĆ, Rade | OJK | | 13. maj, Ub |
| PETROVIĆ, Nenad | OJK | 4 | PETROVIĆ, Nenad |
| NOVKOVIĆ, Nenad | ZMA | | ODŽK Beograd, Beograd |
| COJIĆ, Lazar | ASD | 5 | PAVLOVIĆ, Rade |
| PAVLOVIĆ, Rade | OJK | | ODŽK Beograd, Beograd |
| JELIĆ, Nikola | 13U | 6 | JELIĆ, Nikola |
| NOVKOVIĆ, Nenad | ZMA | | 13. maj, Ub |
| PETROVIĆ, Nenad | OJK | 7 | PETROVIĆ, Nenad |
| COJIĆ, Lazar | ASD | | ODŽK Beograd, Beograd |
| NOVKOVIĆ, Nenad | ZMA | 8 | NOVKOVIĆ, Nenad |
| PAVLOVIĆ, Rade | OJK | | Zmaj, Srpski Krstur |
| JELIĆ, Nikola | 13U | 9 | JELIĆ, Nikola |
| COJIĆ, Lazar | ASD | | 13. maj, Ub |
| PETROVIĆ, Nenad | OJK | 10 | PETROVIĆ, Nenad |
| PAVLOVIĆ, Rade | OJK | | ODŽK Beograd, Beograd |

Rezultati

- PETROVIĆ, Nenad OJK
- JELIĆ, Nikola 13U
- NOVKOVIĆ, Nenad ZMA
- PAVLOVIĆ, Rade OJK
- COJIĆ, Lazar ASD



VLADAN PETROVIĆ I DAN

Beograd, 13.04.2024.

MLAĐI KADETI

-66KG

11 takmičara

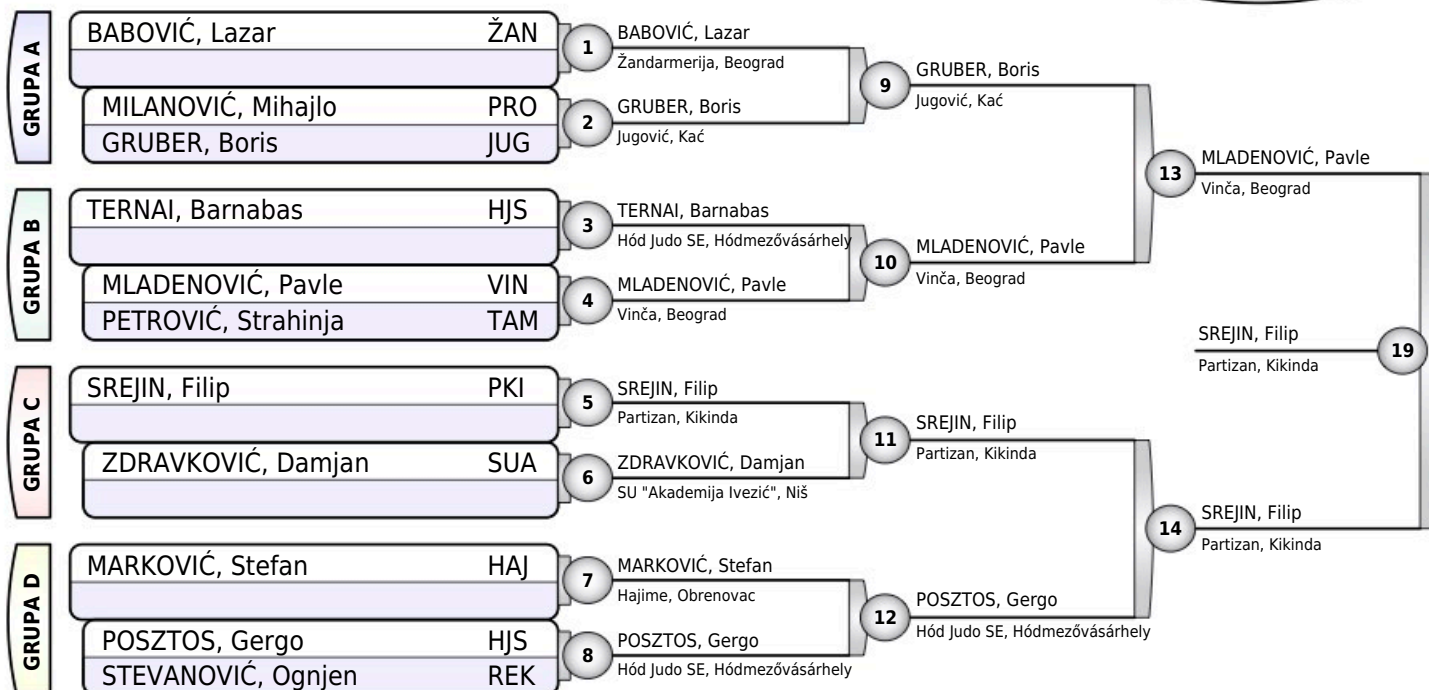

Rezultati

- SREJIN, Filip PKI
- MLADENOVIĆ, Pavle VIN
- GRUBER, Boris JUG
- ZDRAVKOVIĆ, Damjan SUA
- TERNAI, Barnabas HJS
- POSZTOS, Gergo HJS
- PETROVIĆ, Strahinja TAM
-

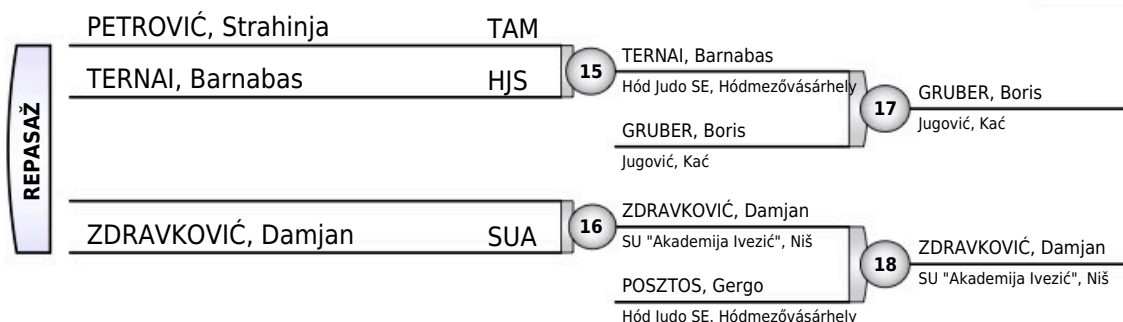



VLADAN PETROVIĆ I DAN

Beograd, 13.04.2024.

MLAĐI KADETI

-73KG

10 takmičara

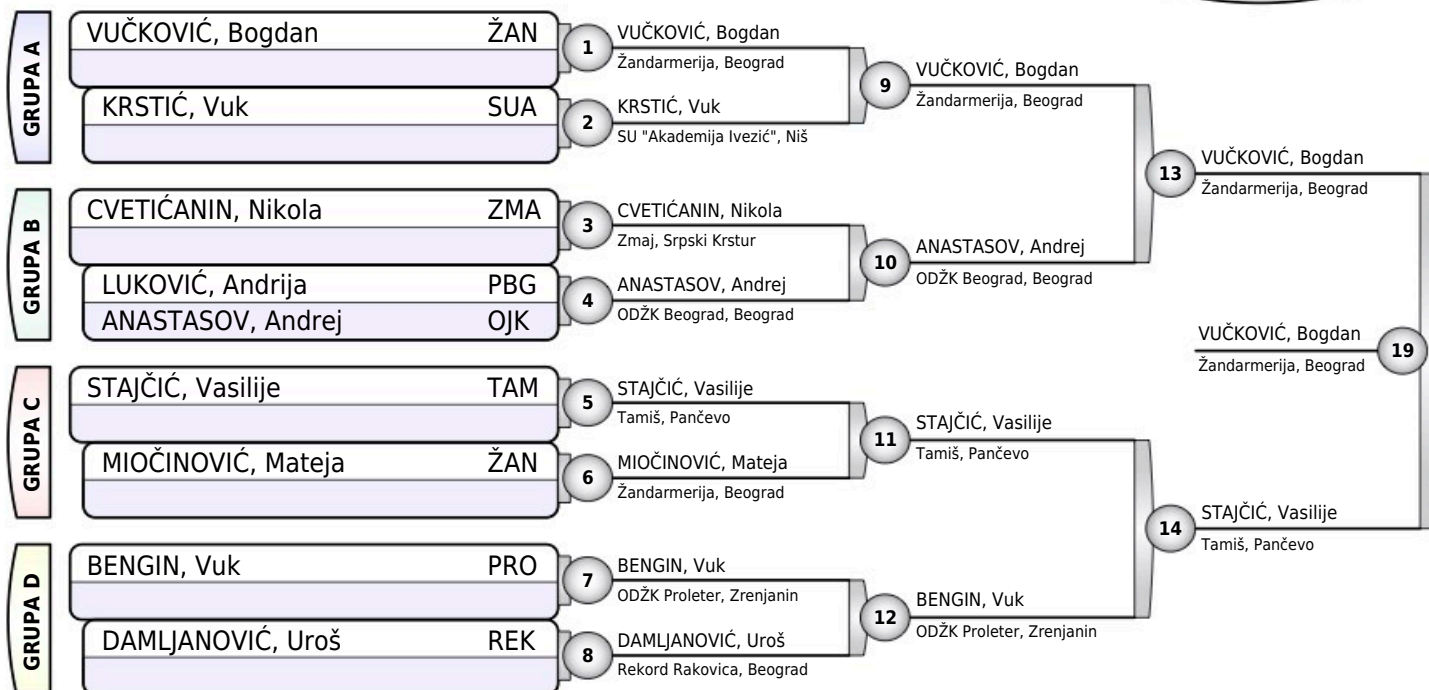

Rezultati

1. VUČKOVIĆ, Bogdan ŽAN
2. STAJČIĆ, Vasilije TAM
3. ANASTASOV, Andrej OJK
3. MIOČINOVIĆ, Mateja ŽAN
5. KRSTIĆ, Vuk SUA
5. BENGIN, Vuk PRO
- 7.
- 7.

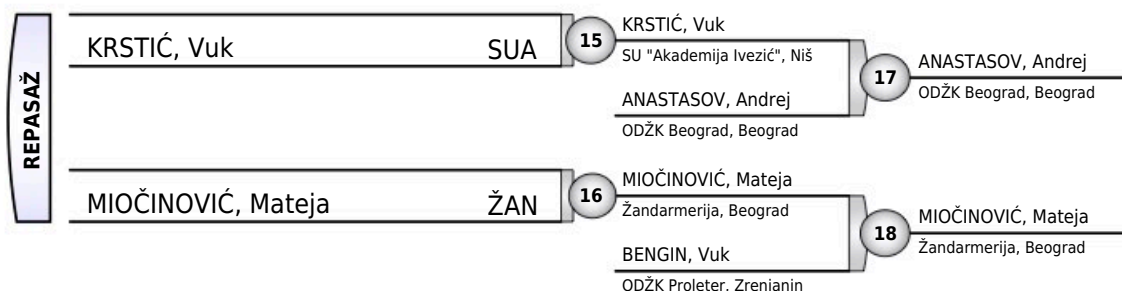



VLADAN PETROVIĆ I DAN

Beograd, 13.04.2024.

MLAĐI KADETI

-81KG

3 takmičara

| TAKMIČAR I KLUB | 1 | 2 | 3 | POBEDA | BODOVA | MESTO |
|--|----|---|----|--------|--------|-------|
| 1 PETROV, Nemanja Partizan, Kikinda | | 0 | 0 | 0 | 0 | 3 |
| 2 DRAGAŠ, Komnen Crvena Zvezda, Beograd | 10 | | 10 | 2 | 20 | 1 |
| 3 VUČIĆEVIĆ, Mihajlo Crvena Zvezda, Beograd | 10 | 0 | | 1 | 10 | 2 |

| | | | |
|--------------------|-----|---|------------------------|
| PETROV, Nemanja | PKI | 1 | DRAGAŠ, Komnen |
| DRAGAŠ, Komnen | CZB | | Crvena Zvezda, Beograd |
| PETROV, Nemanja | PKI | 2 | VUČIĆEVIĆ, Mihajlo |
| VUČIĆEVIĆ, Mihajlo | CZB | | Crvena Zvezda, Beograd |
| DRAGAŠ, Komnen | CZB | 3 | DRAGAŠ, Komnen |
| VUČIĆEVIĆ, Mihajlo | CZB | | Crvena Zvezda, Beograd |

Rezultati

1. DRAGAŠ, Komnen CZB
2. VUČIĆEVIĆ, Mihajlo CZB
3. PETROV, Nemanja PKI



VLADAN PETROVIĆ I DAN

Beograd, 13.04.2024.

MLAĐI KADETI

+81KG

4 takmičara

| TAKMIČAR I KLUB | 1 | 2 | 3 | 4 | POBEDA | BODOVA | MESTO |
|--|-----|-----|-----|-----|--------|--------|-------|
| 1 MARIJAN, Ognjen Žandarmerija, Beograd | /// | 1 | 1 | 10 | 3 | 12 | 1 |
| 2 VUKOB RAT, Nikola Novi Beograd, Beograd | 0 | /// | 10 | 0 | 1 | 10 | 3 |
| 3 POPOVIC, Nikola Fajter, Obrenovac | 0 | 0 | /// | 0 | 0 | 0 | 3 |
| 4 ŽIVKOVIĆ, Lazar Žandarmerija, Beograd | 0 | 10 | 10 | /// | 2 | 20 | 2 |

| | | | |
|-------------------|-----|---|-----------------------|
| MARIJAN, Ognjen | ŽAN | 1 | MARIJAN, Ognjen |
| VUKOB RAT, Nikola | NBG | | Žandarmerija, Beograd |
| POPOVIC, Nikola | FAJ | 2 | ŽIVKOVIĆ, Lazar |
| ŽIVKOVIĆ, Lazar | ŽAN | | Žandarmerija, Beograd |
| MARIJAN, Ognjen | ŽAN | 3 | MARIJAN, Ognjen |
| POPOVIC, Nikola | FAJ | | Žandarmerija, Beograd |
| VUKOB RAT, Nikola | NBG | 4 | ŽIVKOVIĆ, Lazar |
| ŽIVKOVIĆ, Lazar | ŽAN | | Žandarmerija, Beograd |
| MARIJAN, Ognjen | ŽAN | 5 | MARIJAN, Ognjen |
| ŽIVKOVIĆ, Lazar | ŽAN | | Žandarmerija, Beograd |
| VUKOB RAT, Nikola | NBG | 6 | VUKOB RAT, Nikola |
| POPOVIC, Nikola | FAJ | | Novi Beograd, Beograd |

Rezultati

- | | |
|----------------------|-----|
| 1. MARIJAN, Ognjen | ŽAN |
| 2. ŽIVKOVIĆ, Lazar | ŽAN |
| 3. VUKOB RAT, Nikola | NBG |
| 3. POPOVIC, Nikola | FAJ |



VLADAN PETROVIĆ I DAN

Beograd, 13.04.2024.

MLAĐE KADETKINJE

-44KG

2 takmičarke

| | | | |
|----------------|-----|---|-----------------------|
| GRGAREVIĆ, Iva | NIT | 1 | STOJANOV, Ina |
| STOJANOV, Ina | ŽAN | | Žandarmerija, Beograd |
| GRGAREVIĆ, Iva | NIT | 2 | STOJANOV, Ina |
| STOJANOV, Ina | ŽAN | | Žandarmerija, Beograd |
| | | 3 | |

Rezultati

1. STOJANOV, Ina ŽAN
2. GRGAREVIĆ, Iva NIT



VLADAN PETROVIĆ I DAN

Beograd, 13.04.2024.

MLAĐE KADETKINJE

-48KG

8 takmičarki

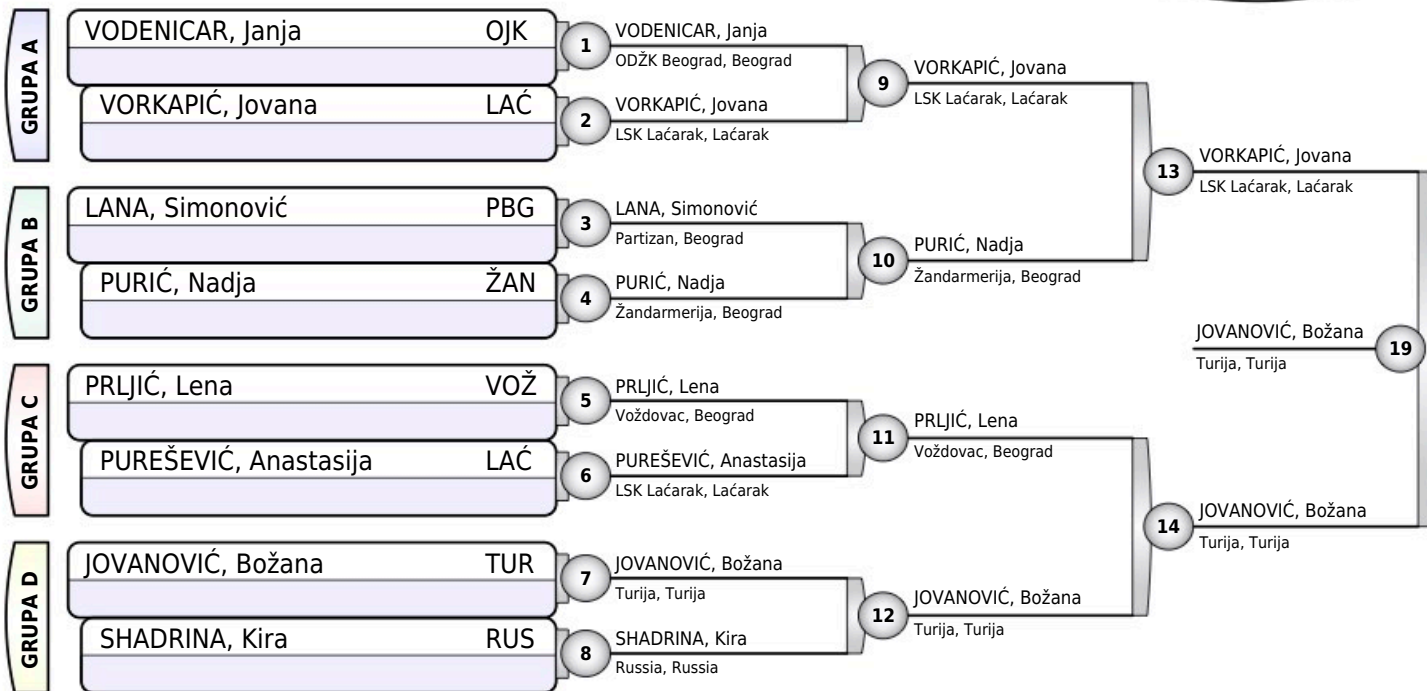

Rezultati

1. JOVANOVIĆ, Božana TUR
2. VORKAPIĆ, Jovana LAĆ
3. VODENICAR, Janja OJK
3. SHADRINA, Kira RUS
5. PURIĆ, Nadja ŽAN
5. PRLJIĆ, Lena VOŽ
- 7.
- 7.





VLADAN PETROVIĆ I DAN

Beograd, 13.04.2024.

MLAĐE KADETKINJE

-52KG

5 takmičarki

| TAKMIČAR I KLUB | 1 | 2 | 3 | 4 | 5 | POBEDA | BODOVA | MESTO |
|--|-----|-----|-----|-----|-----|--------|--------|-------|
| 1 PALLAI DÓRA, Margit Hód Judo SE, Hódmezővásárhely | /// | 10 | 0 | 0 | 10 | 2 | 20 | 3 |
| 2 STAJČIĆ, Teodora Hajime, Obrenovac | 0 | /// | 0 | 0 | 10 | 1 | 10 | 3 |
| 3 TODORVIĆ, Anđela SU Fudži, Beograd | 10 | 10 | /// | 10 | 10 | 4 | 40 | 1 |
| 4 ROŠKOVIĆ, Nevena SU "Akademik SD", Smederevo | 10 | 10 | 0 | /// | 10 | 3 | 30 | 2 |
| 5 PRLJIĆ, Jana Voždovac, Beograd | 0 | 0 | 0 | 0 | /// | 0 | 0 | 5 |

| | | | |
|---------------------|-----|----|-------------------------------|
| PALLAI DÓRA, Margit | HJS | 1 | PALLAI DÓRA, Margit |
| STAJČIĆ, Teodora | HAJ | | Hód Judo SE, Hódmezővásárhely |
| TODORVIĆ, Anđela | FDŽ | 2 | TODORVIĆ, Anđela |
| ROŠKOVIĆ, Nevena | ASD | | SU Fudži, Beograd |
| PALLAI DÓRA, Margit | HJS | 3 | PALLAI DÓRA, Margit |
| PRLJIĆ, Jana | VOŽ | | Hód Judo SE, Hódmezővásárhely |
| STAJČIĆ, Teodora | HAJ | 4 | TODORVIĆ, Anđela |
| TODORVIĆ, Anđela | FDŽ | | SU Fudži, Beograd |
| ROŠKOVIĆ, Nevena | ASD | 5 | ROŠKOVIĆ, Nevena |
| PRLJIĆ, Jana | VOŽ | | SU "Akademik SD", Smederevo |
| PALLAI DÓRA, Margit | HJS | 6 | TODORVIĆ, Anđela |
| TODORVIĆ, Anđela | FDŽ | | SU Fudži, Beograd |
| STAJČIĆ, Teodora | HAJ | 7 | ROŠKOVIĆ, Nevena |
| ROŠKOVIĆ, Nevena | ASD | | SU "Akademik SD", Smederevo |
| TODORVIĆ, Anđela | FDŽ | 8 | TODORVIĆ, Anđela |
| PRLJIĆ, Jana | VOŽ | | SU Fudži, Beograd |
| PALLAI DÓRA, Margit | HJS | 9 | ROŠKOVIĆ, Nevena |
| ROŠKOVIĆ, Nevena | ASD | | SU "Akademik SD", Smederevo |
| STAJČIĆ, Teodora | HAJ | 10 | STAJČIĆ, Teodora |
| PRLJIĆ, Jana | VOŽ | | Hajime, Obrenovac |

Rezultati

1. TODORVIĆ, Anđela FDŽ
2. ROŠKOVIĆ, Nevena ASD
3. PALLAI DÓRA, Margit HJS
3. STAJČIĆ, Teodora HAJ
5. PRLJIĆ, Jana VOŽ



VLADAN PETROVIĆ I DAN

Beograd, 13.04.2024.

MLAĐE KADETKINJE

-57KG

5 takmičarki

| TAKMIČAR I KLUB | 1 | 2 | 3 | 4 | 5 | POBEDA | BODOVA | MESTO |
|--|----|----|---|----|----|--------|--------|-------|
| 1 DIMIĆ, Sara ODŽK Beograd, Beograd | | 0 | 0 | 0 | 10 | 1 | 10 | 3 |
| 2 BANJAC, Sara Partizan, Kikinda | 10 | | 0 | 0 | 10 | 2 | 20 | 3 |
| 3 ČIKARIĆ, Dunja Radnički, Beograd | 10 | 10 | | 10 | 10 | 4 | 40 | 1 |
| 4 ŠIKOPARIJA, Dunja Radnički, Beograd | 10 | 10 | 0 | | 10 | 3 | 30 | 2 |
| 5 KRSTEVSKI, Lena Voždovac, Beograd | 0 | 0 | 0 | 0 | | 0 | 0 | 5 |

| | | | |
|-------------------|-----|----|-----------------------|
| DIMIĆ, Sara | OJK | 1 | BANJAC, Sara |
| BANJAC, Sara | PKI | | Partizan, Kikinda |
| ČIKARIĆ, Dunja | RAD | 2 | ČIKARIĆ, Dunja |
| ŠIKOPARIJA, Dunja | RAD | | Radnički, Beograd |
| DIMIĆ, Sara | OJK | 3 | DIMIĆ, Sara |
| KRSTEVSKI, Lena | VOŽ | | ODŽK Beograd, Beograd |
| BANJAC, Sara | PKI | 4 | ČIKARIĆ, Dunja |
| ČIKARIĆ, Dunja | RAD | | Radnički, Beograd |
| ŠIKOPARIJA, Dunja | RAD | 5 | ŠIKOPARIJA, Dunja |
| KRSTEVSKI, Lena | VOŽ | | Radnički, Beograd |
| DIMIĆ, Sara | OJK | 6 | ČIKARIĆ, Dunja |
| ČIKARIĆ, Dunja | RAD | | Radnički, Beograd |
| BANJAC, Sara | PKI | 7 | ŠIKOPARIJA, Dunja |
| ŠIKOPARIJA, Dunja | RAD | | Radnički, Beograd |
| ČIKARIĆ, Dunja | RAD | 8 | ČIKARIĆ, Dunja |
| KRSTEVSKI, Lena | VOŽ | | Radnički, Beograd |
| DIMIĆ, Sara | OJK | 9 | ŠIKOPARIJA, Dunja |
| ŠIKOPARIJA, Dunja | RAD | | Radnički, Beograd |
| BANJAC, Sara | PKI | 10 | BANJAC, Sara |
| KRSTEVSKI, Lena | VOŽ | | Partizan, Kikinda |

Rezultati

1. ČIKARIĆ, Dunja RAD
2. ŠIKOPARIJA, Dunja RAD
3. BANJAC, Sara PKI
3. DIMIĆ, Sara OJK
5. KRSTEVSKI, Lena VOŽ



VLADAN PETROVIĆ I DAN

Beograd, 13.04.2024.

MLAĐE KADETKINJE

-63KG

5 takmičarki

| TAKMIČAR I KLUB | 1 | 2 | 3 | 4 | 5 | POBEDA | BODOVA | MESTO |
|--|-----|-----|-----|-----|-----|--------|--------|-------|
| 1 JOVANOVIĆ, Jovana Turija, Turija | --- | 0 | 0 | 10 | 0 | 1 | 10 | 3 |
| 2 ALEKSIĆ, Hana Novi Beograd, Beograd | 10 | --- | 0 | 10 | 0 | 2 | 20 | 3 |
| 3 TÖRÖK, Csenge Hód Judo SE, Hódmezővásárhely | 10 | 10 | --- | 10 | 0 | 3 | 30 | 2 |
| 4 VOJVODIĆ, Dunja Žandarmerija, Beograd | 0 | 0 | 0 | --- | 0 | 0 | 0 | 5 |
| 5 BANIKAI, Marija Jugović, Kać | 10 | 10 | 1 | 10 | --- | 4 | 31 | 1 |

| | | | |
|-------------------|-----|----|-------------------------------|
| JOVANOVIĆ, Jovana | TUR | 1 | ALEKSIĆ, Hana |
| ALEKSIĆ, Hana | NBG | | Novi Beograd, Beograd |
| TÖRÖK, Csenge | HJS | 2 | TÖRÖK, Csenge |
| VOJVODIĆ, Dunja | ŽAN | | Hód Judo SE, Hódmezővásárhely |
| JOVANOVIĆ, Jovana | TUR | 3 | BANIKAI, Marija |
| BANIKAI, Marija | JUG | | Jugović, Kać |
| ALEKSIĆ, Hana | NBG | 4 | TÖRÖK, Csenge |
| TÖRÖK, Csenge | HJS | | Hód Judo SE, Hódmezővásárhely |
| VOJVODIĆ, Dunja | ŽAN | 5 | BANIKAI, Marija |
| BANIKAI, Marija | JUG | | Jugović, Kać |
| JOVANOVIĆ, Jovana | TUR | 6 | TÖRÖK, Csenge |
| TÖRÖK, Csenge | HJS | | Hód Judo SE, Hódmezővásárhely |
| ALEKSIĆ, Hana | NBG | 7 | ALEKSIĆ, Hana |
| VOJVODIĆ, Dunja | ŽAN | | Novi Beograd, Beograd |
| TÖRÖK, Csenge | HJS | 8 | BANIKAI, Marija |
| BANIKAI, Marija | JUG | | Jugović, Kać |
| JOVANOVIĆ, Jovana | TUR | 9 | JOVANOVIĆ, Jovana |
| VOJVODIĆ, Dunja | ŽAN | | Turija, Turija |
| ALEKSIĆ, Hana | NBG | 10 | BANIKAI, Marija |
| BANIKAI, Marija | JUG | | Jugović, Kać |

Rezultati

1. BANIKAI, Marija JUG
2. TÖRÖK, Csenge HJS
3. ALEKSIĆ, Hana NBG
3. JOVANOVIĆ, Jovana TUR
5. VOJVODIĆ, Dunja ŽAN



VLADAN PETROVIĆ I DAN

Beograd, 13.04.2024.

MLAĐE KADETKINJE

-70KG

1 takmičarka

ARSENJEVIĆ, Anđelija

ČUK

1

ARSENJEVIĆ, Anđelija

Čukarički, Beograd

Rezultati

1. ARSENJEVIĆ, Anđelija

ČUK



VLADAN PETROVIĆ I DAN

Beograd, 13.04.2024.

MLAĐE KADETKINJE

+70KG

3 takmičarke

| TAKMIČAR I KLUB | 1 | 2 | 3 | POBEDA | BODOVA | MESTO |
|--|----|---|----|--------|--------|-------|
| 1 ĆELBABIN, Mirjana Turija, Turija | | 0 | 10 | 1 | 10 | 2 |
| 2 MRAKOVIĆ, Una Crvena Zvezda, Beograd | 10 | | 10 | 2 | 20 | 1 |
| 3 PILIPOVIĆ, Maša LSK Lačarak, Lačarak | 0 | 0 | | 0 | 0 | 3 |

| | | | |
|-------------------|-----|---|------------------------|
| ĆELBABIN, Mirjana | TUR | 1 | MRAKOVIĆ, Una |
| MRAKOVIĆ, Una | CZB | | Crvena Zvezda, Beograd |
| ĆELBABIN, Mirjana | TUR | 2 | ĆELBABIN, Mirjana |
| PILIPOVIĆ, Maša | LAĆ | | Turija, Turija |
| MRAKOVIĆ, Una | CZB | 3 | MRAKOVIĆ, Una |
| PILIPOVIĆ, Maša | LAĆ | | Crvena Zvezda, Beograd |

Rezultati

1. MRAKOVIĆ, Una CZB
2. ĆELBABIN, Mirjana TUR
3. PILIPOVIĆ, Maša LAĆ