

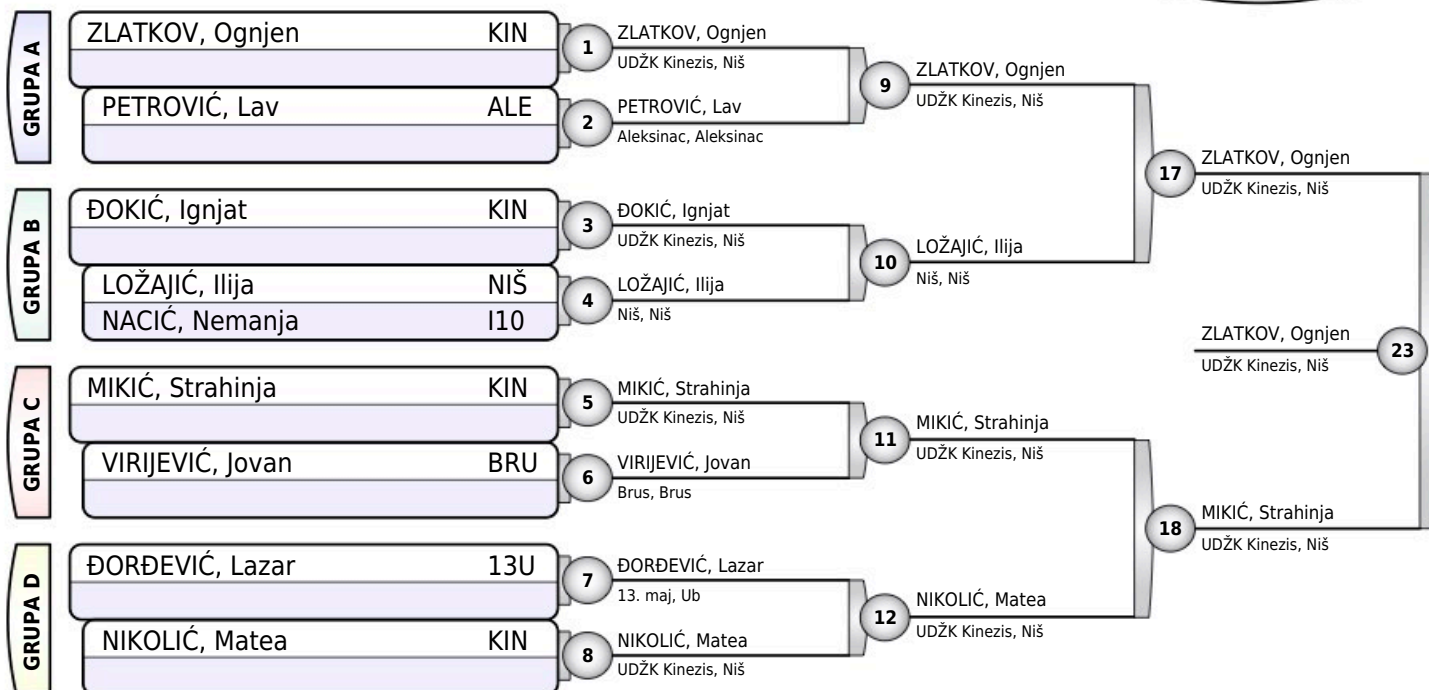

# REGIONALNO CS JUNIORI

Čačak, 22.03.2025.

JUNIORI  
**-60KG**  
9 takmičara



## Rezultati

- ZLATKOV, Ognjen KIN
- MIKIĆ, Strahinja KIN
- NIKOLIĆ, Matea KIN
- LOŽAJIĆ, Ilija NIŠ
- PETROVIĆ, Lav ALE
- ĐORĐEVIĆ, Lazar 13U
- ĐOKIĆ, Ignjat KIN
- VIRIJEVIĆ, Jovan BRU

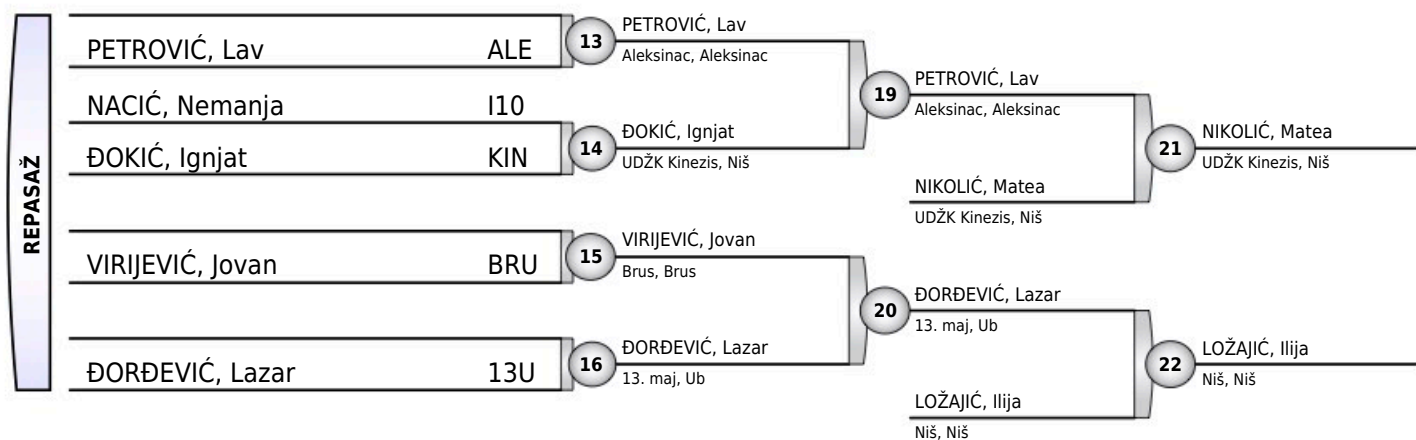



# REGIONALNO CS JUNIORI

Čačak, 22.03.2025.

JUNIORI  
**-66KG**  
11 takmičara

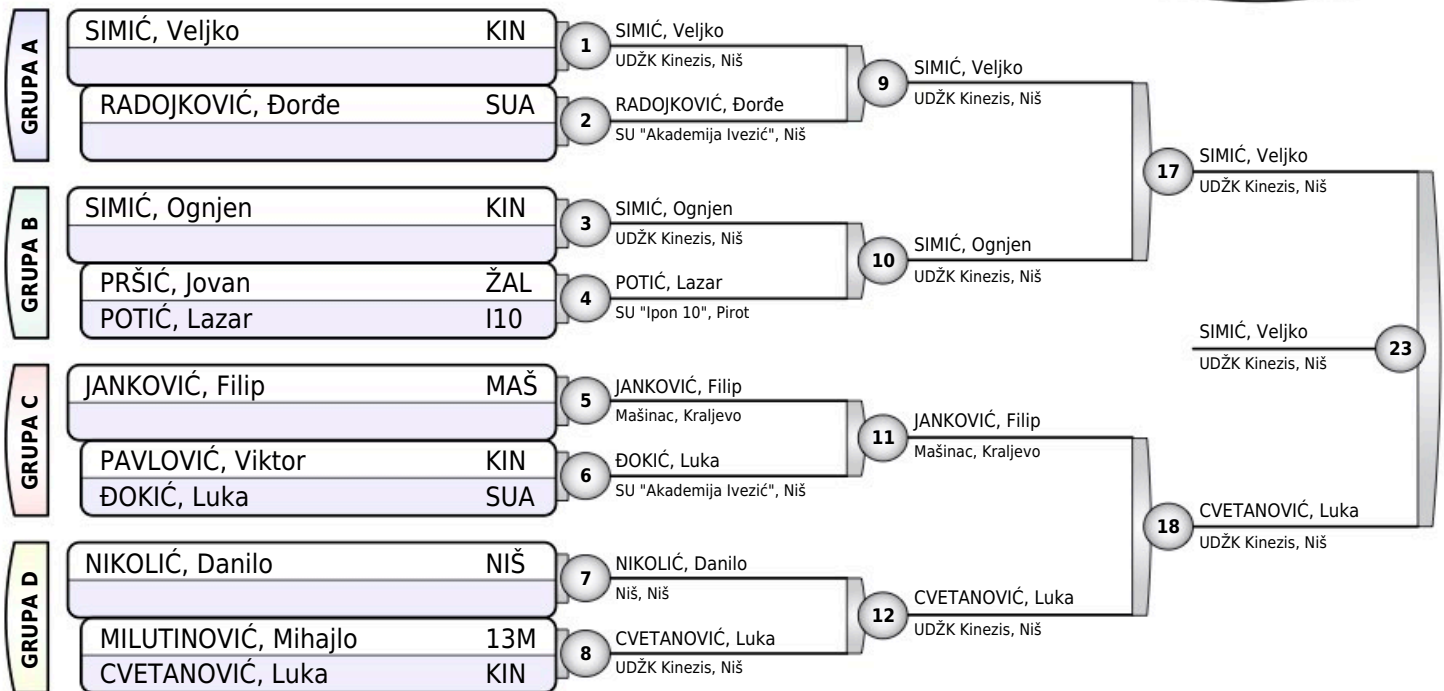

## Rezultati

- |    |                      |     |
|----|----------------------|-----|
| 1. | SIMIĆ, Veljko        | KIN |
| 2. | CVETANOVIĆ, Luka     | KIN |
| 3. | RADOJKOVIĆ, Đorđe    | SUA |
| 3. | SIMIĆ, Ognjen        | KIN |
| 5. | JANKOVIĆ, Filip      | MAŠ |
| 5. | ĐOKIĆ, Luka          | SUA |
| 7. | POTIĆ, Lazar         | I10 |
| 7. | MILUTINOVIĆ, Mihajlo | 13M |

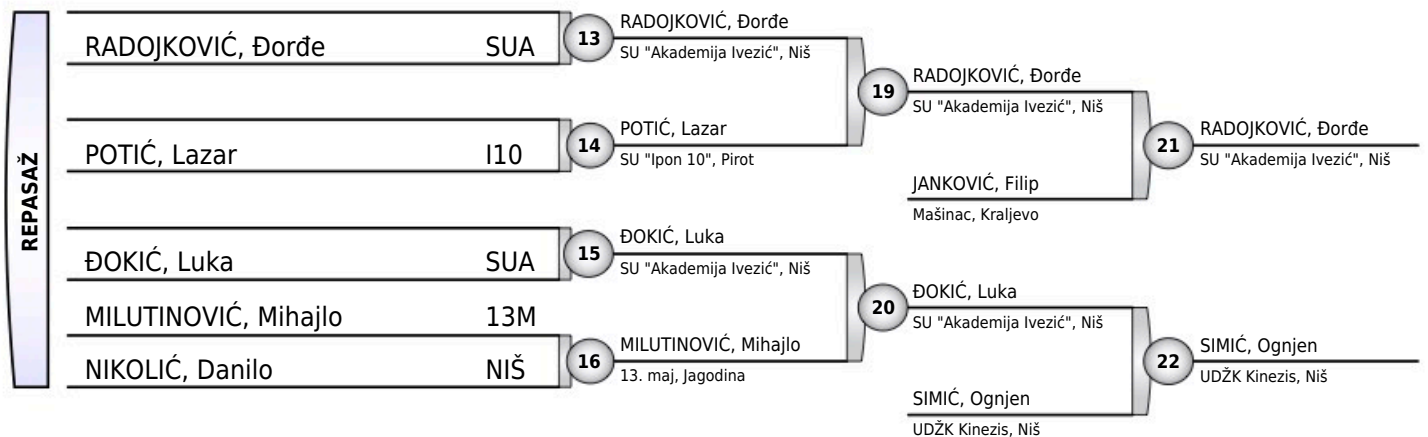



# REGIONALNO CS JUNIORI

Čačak, 22.03.2025.

JUNIORI  
**-73KG**  
13 takmičara

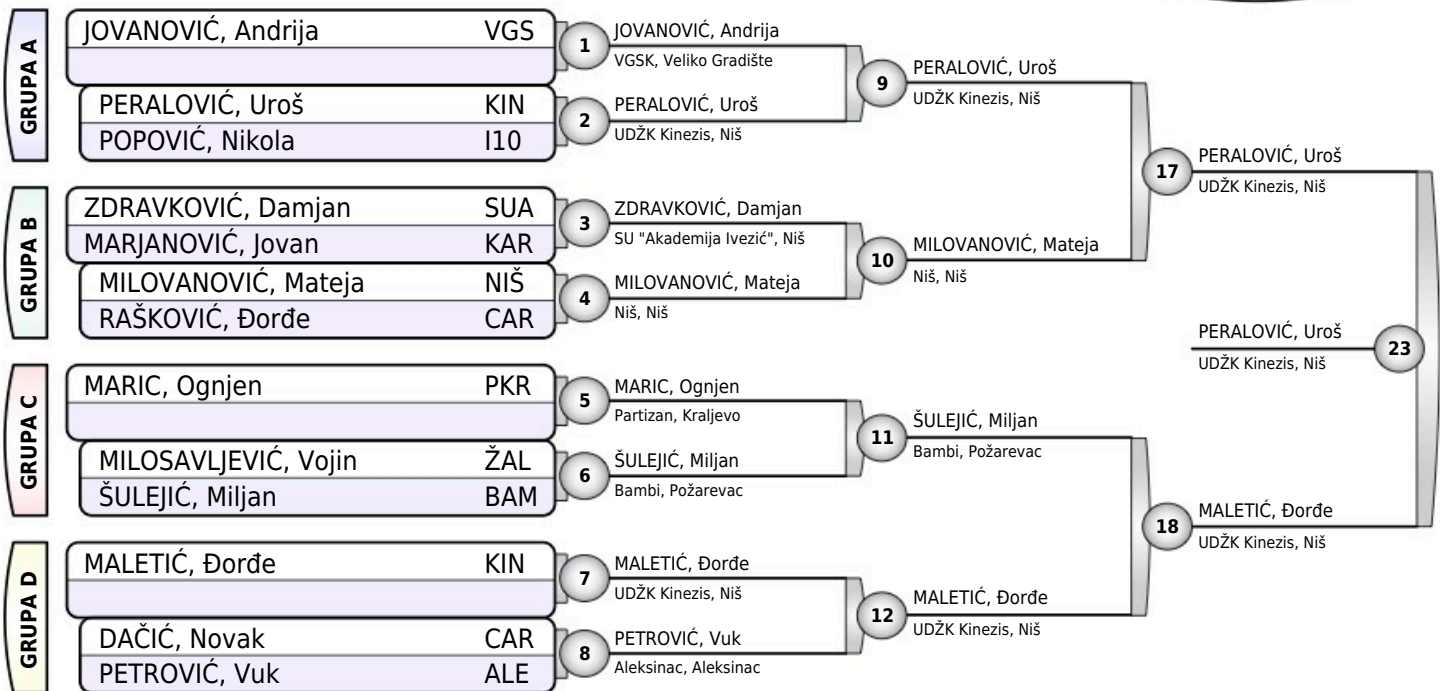

## Rezultati

- PERALOVIĆ, Uroš KIN
- MALETIĆ, Đorđe KIN
- JOVANOVIĆ, Andrija VGS
- MILOVANOVIĆ, Mateja NIŠ
- ŠULEJIĆ, Miljan BAM
- MILOSAVLJEVIĆ, Vojin ŽAL
- ZDRAVKOVIĆ, Damjan SUA
- PETROVIĆ, Vuk ALE

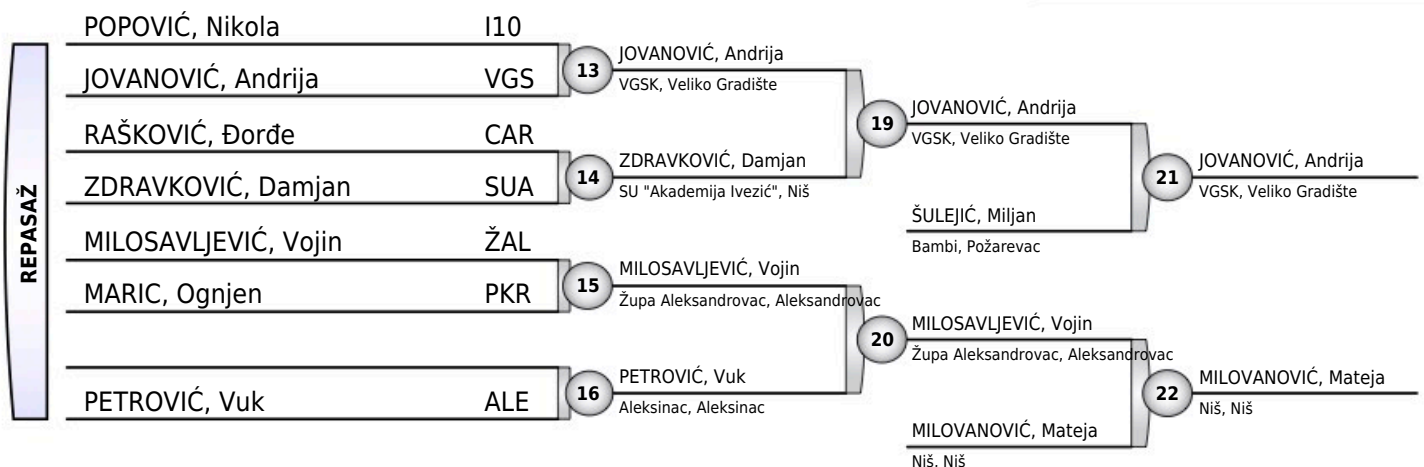



# REGIONALNO CS JUNIORI

Čačak, 22.03.2025.

JUNIORI  
**-81KG**  
9 takmičara

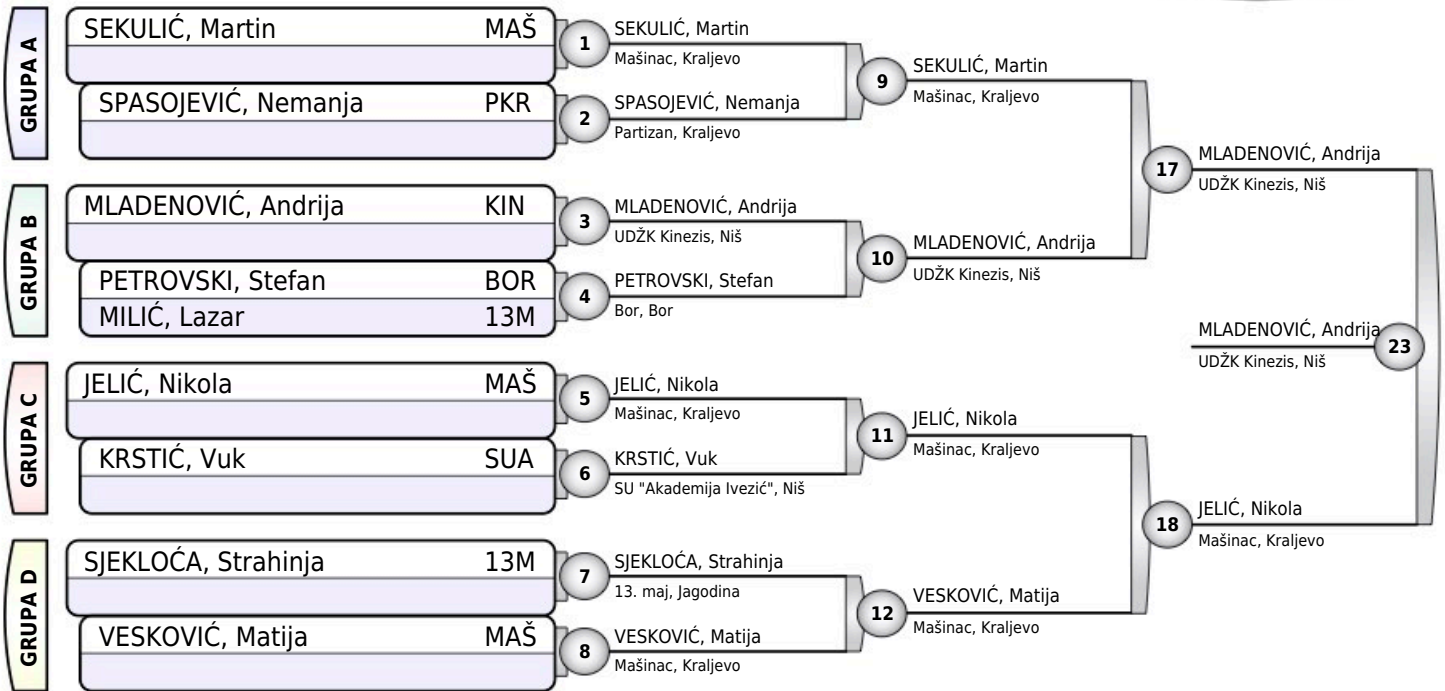

## Rezultati

1. MLADENOVIĆ, Andrija KIN
2. JELIĆ, Nikola MAŠ
3. PETROVSKI, Stefan BOR
3. SEKULIĆ, Martin MAŠ
5. VESKOVIĆ, Matija MAŠ
5. KRSTIĆ, Vuk SUA
7. SPASOJEVIĆ, Nemanja PKR
7. SJEKLOĆA, Strahinja 13M

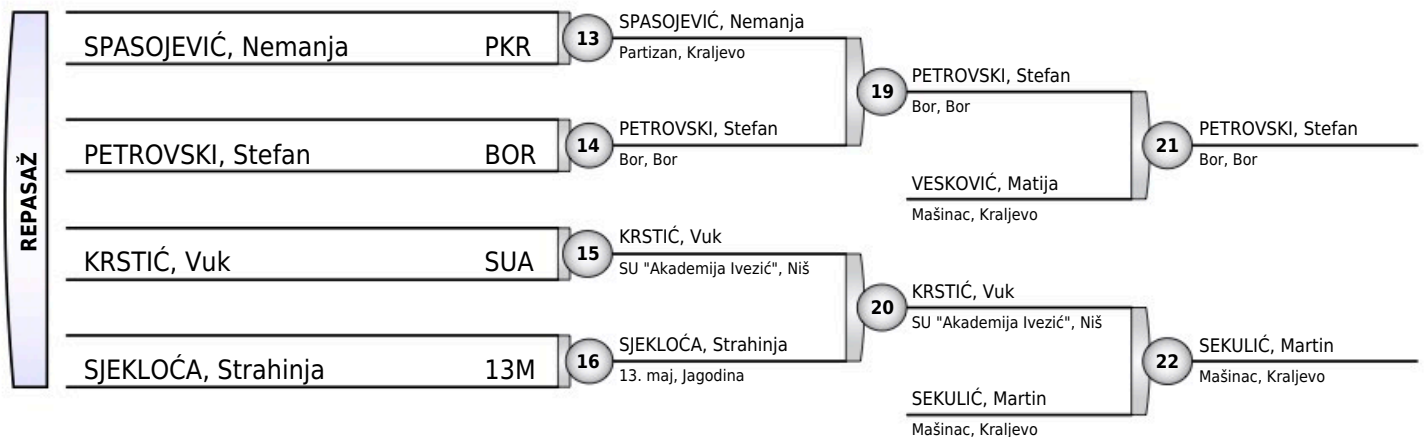



# REGIONALNO CS JUNIORI

Čačak, 22.03.2025.

JUNIORI  
**-90KG**  
5 takmičara

TAKMIČAR I KLUB	1	2	3	4	5	POBEDA	BODOVA	MESTO
1 VAŠČUK, Ivan Župa Aleksandrovac, Aleksandrovac		100	0	100	100	3	300	2
2 ĆIRKOVIĆ, Milan VGSK, Veliko Gradište	0		0	0	100	1	100	3
3 STOILJKOVIĆ, Lazar Aleksinac, Aleksinac	100	10		100	100	4	310	1
4 TOŠIĆ, Petar SU "Ipon 10", Pirot	0	100	0		100	2	200	3
5 MILOŠEVIĆ, Matija VGSK, Veliko Gradište	0	0	0	0		0	0	5

VAŠČUK, Ivan	ŽAL	1	VAŠČUK, Ivan
ĆIRKOVIĆ, Milan	VGS		Župa Aleksandrovac, Aleksandrovac
STOILJKOVIĆ, Lazar	ALE	2	STOILJKOVIĆ, Lazar
TOŠIĆ, Petar	I10		Aleksinac, Aleksinac
VAŠČUK, Ivan	ŽAL	3	VAŠČUK, Ivan
MILOŠEVIĆ, Matija	VGS		Župa Aleksandrovac, Aleksandrovac
ĆIRKOVIĆ, Milan	VGS	4	STOILJKOVIĆ, Lazar
STOILJKOVIĆ, Lazar	ALE		Aleksinac, Aleksinac
TOŠIĆ, Petar	I10	5	TOŠIĆ, Petar
MILOŠEVIĆ, Matija	VGS		SU "Ipon 10", Pirot
VAŠČUK, Ivan	ŽAL	6	STOILJKOVIĆ, Lazar
STOILJKOVIĆ, Lazar	ALE		Aleksinac, Aleksinac
ĆIRKOVIĆ, Milan	VGS	7	TOŠIĆ, Petar
TOŠIĆ, Petar	I10		SU "Ipon 10", Pirot
STOILJKOVIĆ, Lazar	ALE	8	STOILJKOVIĆ, Lazar
MILOŠEVIĆ, Matija	VGS		Aleksinac, Aleksinac
VAŠČUK, Ivan	ŽAL	9	VAŠČUK, Ivan
TOŠIĆ, Petar	I10		Župa Aleksandrovac, Aleksandrovac
ĆIRKOVIĆ, Milan	VGS	10	ĆIRKOVIĆ, Milan
MILOŠEVIĆ, Matija	VGS		VGSK, Veliko Gradište

## Rezultati

1. STOILJKOVIĆ, Lazar ALE
2. VAŠČUK, Ivan ŽAL
3. TOŠIĆ, Petar I10
3. ĆIRKOVIĆ, Milan VGS
5. MILOŠEVIĆ, Matija VGS





# REGIONALNO CS JUNIORI

Čačak, 22.03.2025.

JUNIORI  
**-100KG**  
5 takmičara

TAKMIČAR I KLUB	1	2	3	4	5	POBEDA	BODOVA	MESTO
1 DIMITRIJEVIĆ, Andrija Goč, Vrnjačka Banja		0	0	0	0	0	0	5
2 ŠUNDOVIĆ, Veljko Mašinc, Kraljevo	100		100	100	0	3	300	1
3 KOVAČEVIĆ, Luka Šogun, Niš	100	0		100	0	2	200	3
4 MILOJKOVIĆ, Mihajlo Aleksinac, Aleksinac	100	0	0		100	2	200	3
5 VELIČKOVIĆ, Sava SU "Akademija Ivezic", Niš	100	100	10	0		3	210	2

DIMITRIJEVIĆ, Andrija	GOČ	1	ŠUNDOVIĆ, Veljko
ŠUNDOVIĆ, Veljko	MAŠ		Mašinc, Kraljevo
KOVAČEVIĆ, Luka	ŠOG	2	KOVAČEVIĆ, Luka
MILOJKOVIĆ, Mihajlo	ALE		Šogun, Niš
DIMITRIJEVIĆ, Andrija	GOČ	3	VELIČKOVIĆ, Sava
VELIČKOVIĆ, Sava	SUA		SU "Akademija Ivezic", Niš
ŠUNDOVIĆ, Veljko	MAŠ	4	ŠUNDOVIĆ, Veljko
KOVAČEVIĆ, Luka	ŠOG		Mašinc, Kraljevo
MILOJKOVIĆ, Mihajlo	ALE	5	MILOJKOVIĆ, Mihajlo
VELIČKOVIĆ, Sava	SUA		Aleksinac, Aleksinac
DIMITRIJEVIĆ, Andrija	GOČ	6	KOVAČEVIĆ, Luka
KOVAČEVIĆ, Luka	ŠOG		Šogun, Niš
ŠUNDOVIĆ, Veljko	MAŠ	7	ŠUNDOVIĆ, Veljko
MILOJKOVIĆ, Mihajlo	ALE		Mašinc, Kraljevo
KOVAČEVIĆ, Luka	ŠOG	8	VELIČKOVIĆ, Sava
VELIČKOVIĆ, Sava	SUA		SU "Akademija Ivezic", Niš
DIMITRIJEVIĆ, Andrija	GOČ	9	MILOJKOVIĆ, Mihajlo
MILOJKOVIĆ, Mihajlo	ALE		Aleksinac, Aleksinac
ŠUNDOVIĆ, Veljko	MAŠ	10	VELIČKOVIĆ, Sava
VELIČKOVIĆ, Sava	SUA		SU "Akademija Ivezic", Niš

## Rezultati

- |                          |     |
|--------------------------|-----|
| 1. ŠUNDOVIĆ, Veljko      | MAŠ |
| 2. VELIČKOVIĆ, Sava      | SUA |
| 3. KOVAČEVIĆ, Luka       | ŠOG |
| 3. MILOJKOVIĆ, Mihajlo   | ALE |
| 5. DIMITRIJEVIĆ, Andrija | GOČ |



# REGIONALNO CS JUNIORI

Čačak, 22.03.2025.

JUNIORI  
**+100KG**  
1 takmičar

RUSIMOVIĆ, Lazar

ALE

1

RUSIMOVIĆ, Lazar  
Aleksinac, Aleksinac

## Rezultati

1. RUSIMOVIĆ, Lazar

ALE



# REGIONALNO CS JUNIORI

Čačak, 22.03.2025.

JUNIORKE  
**-48KG**  
5 takmičarki

TAKMIČAR I KLUB	1	2	3	4	5	POBEDA	BODOVA	MESTO
1 NIKOLIĆ, Natalija Džudo udruženje Karadorđević, Sokobanja		0	0	0	0	0	0	5
2 RAJKOVIĆ, Anja 13. maj, Jagodina	10		100	100	100	4	310	1
3 KRAJNJANOVIĆ, Sara Bor, Bor	10	0		100	100	3	210	2
4 VOŠTINIĆ, Sara Partizan, Kraljevo	100	0	0		0	1	100	3
5 RADOSAVLJEVIĆ, Helena Mašinac, Kraljevo	100	0	0	100		2	200	3

NIKOLIĆ, Natalija	KAR	1	RAJKOVIĆ, Anja
RAJKOVIĆ, Anja	13M		13. maj, Jagodina
KRAJNJANOVIĆ, Sara	BOR	2	KRAJNJANOVIĆ, Sara
VOŠTINIĆ, Sara	PKR		Bor, Bor
NIKOLIĆ, Natalija	KAR	3	RADOSAVLJEVIĆ, Helena
RADOSAVLJEVIĆ, Helena	MAŠ		Mašinac, Kraljevo
RAJKOVIĆ, Anja	13M	4	RAJKOVIĆ, Anja
KRAJNJANOVIĆ, Sara	BOR		13. maj, Jagodina
VOŠTINIĆ, Sara	PKR	5	RADOSAVLJEVIĆ, Helena
RADOSAVLJEVIĆ, Helena	MAŠ		Mašinac, Kraljevo
NIKOLIĆ, Natalija	KAR	6	KRAJNJANOVIĆ, Sara
KRAJNJANOVIĆ, Sara	BOR		Bor, Bor
RAJKOVIĆ, Anja	13M	7	RAJKOVIĆ, Anja
VOŠTINIĆ, Sara	PKR		13. maj, Jagodina
KRAJNJANOVIĆ, Sara	BOR	8	KRAJNJANOVIĆ, Sara
RADOSAVLJEVIĆ, Helena	MAŠ		Bor, Bor
NIKOLIĆ, Natalija	KAR	9	VOŠTINIĆ, Sara
VOŠTINIĆ, Sara	PKR		Partizan, Kraljevo
RAJKOVIĆ, Anja	13M	10	RAJKOVIĆ, Anja
RADOSAVLJEVIĆ, Helena	MAŠ		13. maj, Jagodina

## Rezultati

- |                          |     |
|--------------------------|-----|
| 1. RAJKOVIĆ, Anja        | 13M |
| 2. KRAJNJANOVIĆ, Sara    | BOR |
| 3. RADOSAVLJEVIĆ, Helena | MAŠ |
| 3. VOŠTINIĆ, Sara        | PKR |
| 5. NIKOLIĆ, Natalija     | KAR |





# REGIONALNO CS JUNIORI

Čačak, 22.03.2025.

JUNIORKE  
**-52KG**  
6 takmičarki

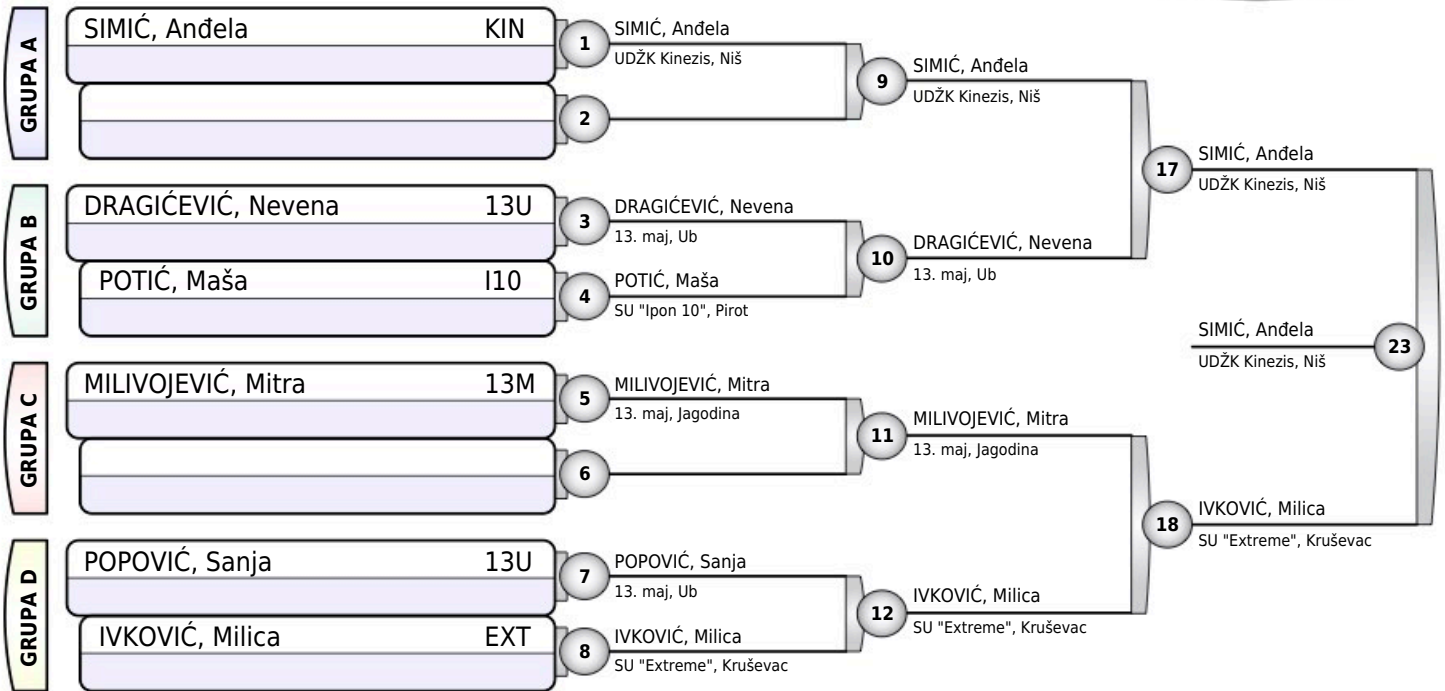

## Rezultati

1. SIMIĆ, Anđela KIN
2. IVKOVIĆ, Milica EXT
3. MILIVOJEVIĆ, Mitra 13M
3. DRAGIĆEVIĆ, Nevena 13U
5. POTIĆ, Maša I10
5. POPOVIĆ, Sanja 13U
- 7.
- 7.

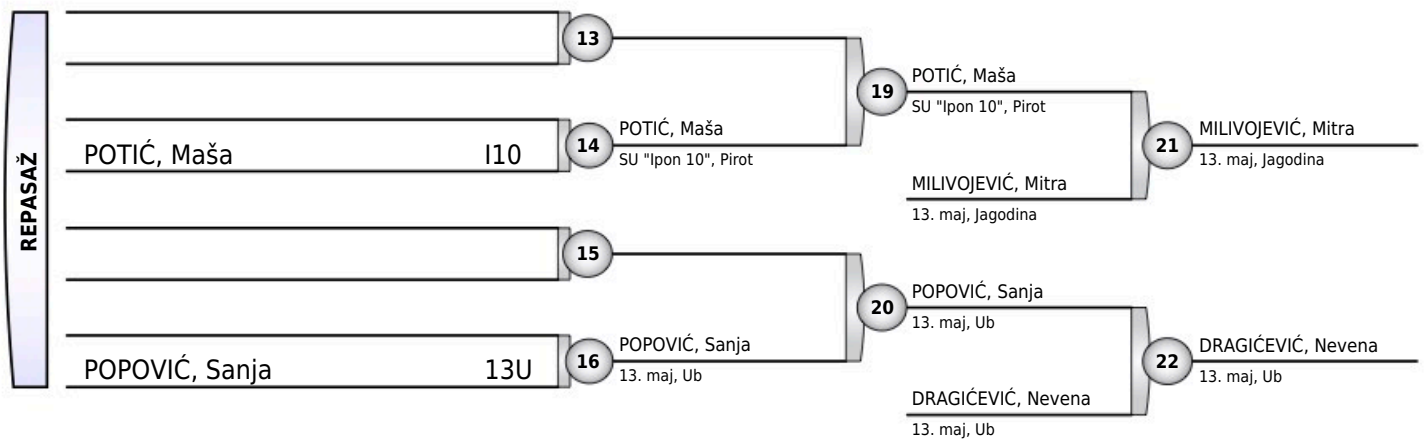



# REGIONALNO CS JUNIORI

Čačak, 22.03.2025.

JUNIORKE  
**-57KG**  
8 takmičarki

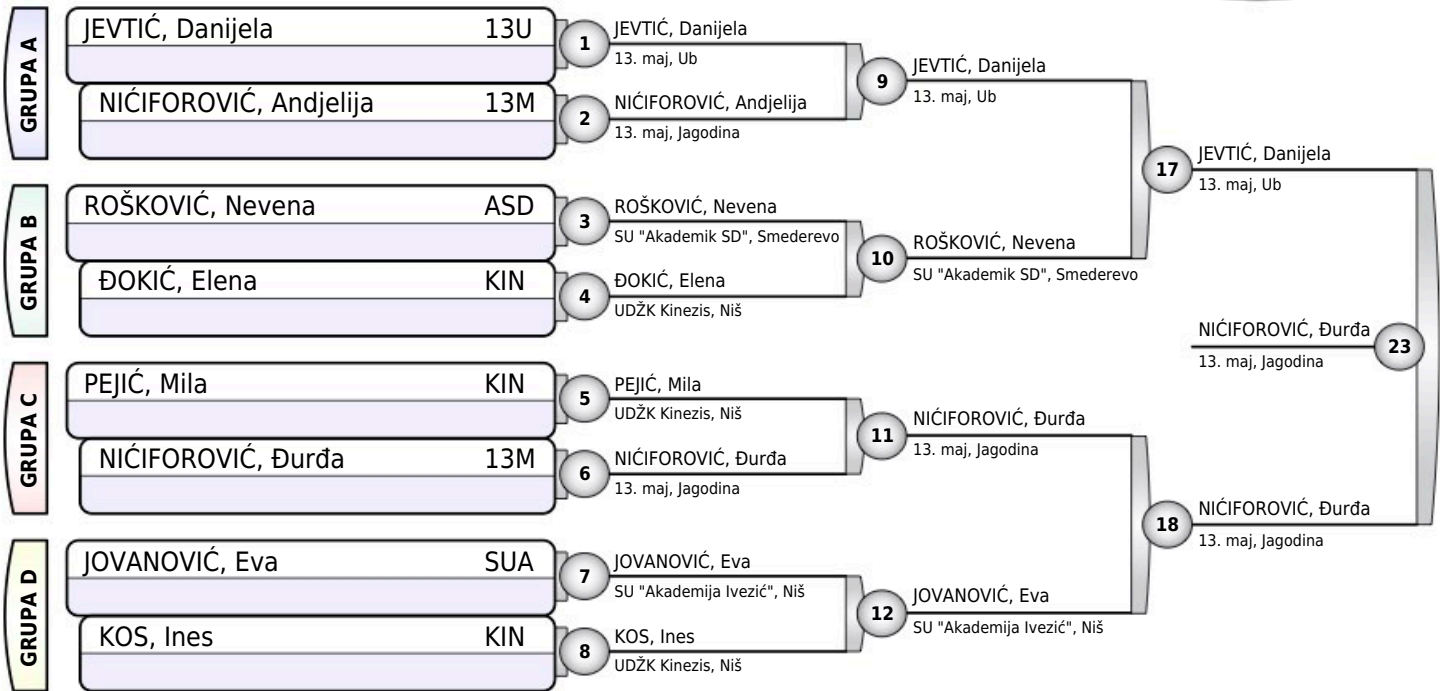

## Rezultati

1. NIĆIFOROVIĆ, Đurđa 13M
2. JEVTIĆ, Danijela 13U
3. JOVANOVIĆ, Eva SUA
3. KOS, Ines KIN
5. ĐOKIĆ, Elena KIN
5. ROŠKOVIĆ, Nevena ASD
7. NIĆIFOROVIĆ, Andjelija 13M
7. PEJIĆ, Mila KIN

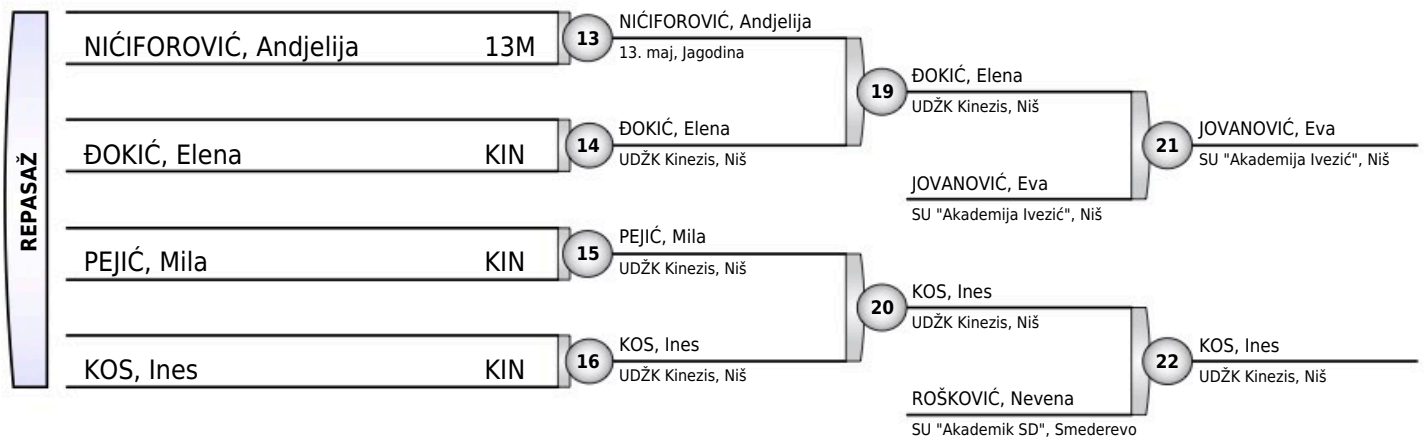



# REGIONALNO CS JUNIORI

Čačak, 22.03.2025.

JUNIORKE  
**-63KG**  
8 takmičarki

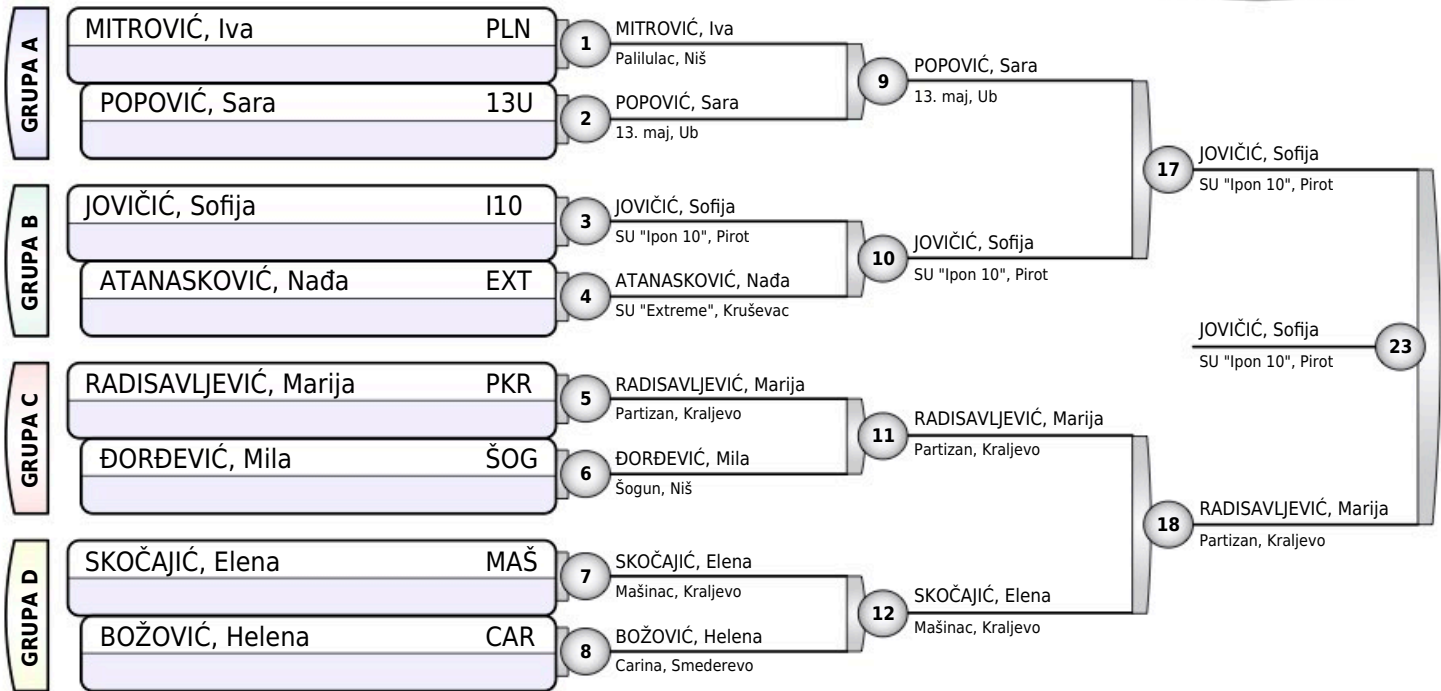

## Rezultati

1. JOVIČIĆ, Sofija I10
2. RADISAVLJEVIĆ, Marija PKR
3. MITROVIĆ, Iva PLN
3. POPOVIĆ, Sara 13U
5. SKOČAJIĆ, Elena MAŠ
5. ĐORĐEVIĆ, Mila ŠOG
7. ATANASKOVIĆ, Nađa EXT
7. BOŽOVIĆ, Helena CAR

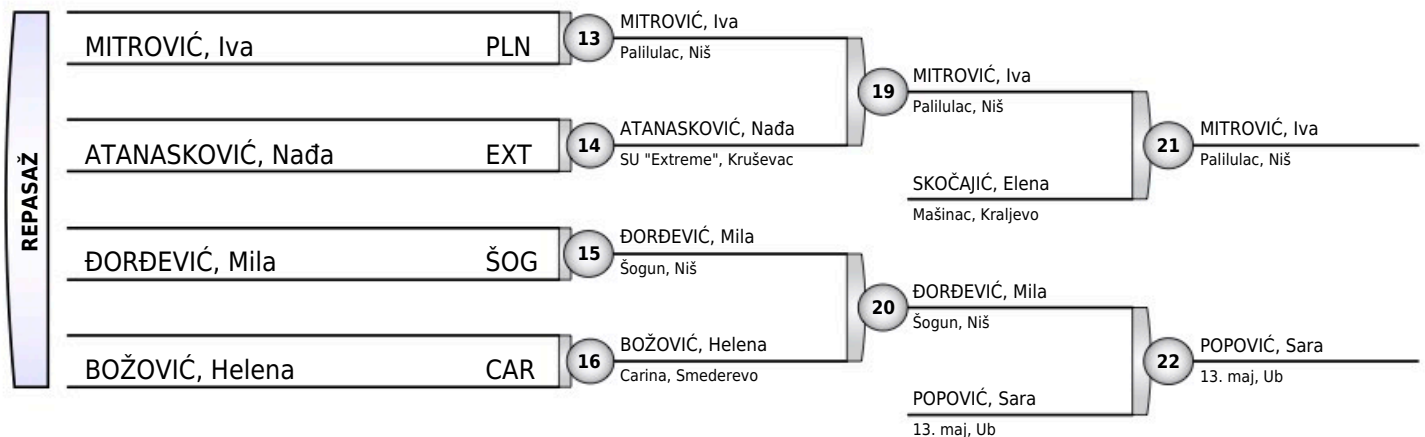



# REGIONALNO CS JUNIORI

Čačak, 22.03.2025.

JUNIORKE  
**-70KG**  
3 takmičarke

TAKMIČAR I KLUB	1	2	3	POBEDA	BODOVA	MESTO
1 SAVIĆ, Anđelija SU "Akademik SD", Smederevo		0	0	0	0	3
2 JELIĆ, Milica 13. maj, Ub	10		0	1	10	2
3 IVANOVIĆ, Anđela Šogun, Niš	100	100		2	200	1

SAVIĆ, Anđelija ASD	1	JELIĆ, Milica 13. maj, Ub
JELIĆ, Milica 13U		
SAVIĆ, Anđelija ASD	2	IVANOVIĆ, Anđela Šogun, Niš
IVANOVIĆ, Anđela ŠOG		
JELIĆ, Milica 13U	3	IVANOVIĆ, Anđela Šogun, Niš
IVANOVIĆ, Anđela ŠOG		

## Rezultati

1. IVANOVIĆ, Anđela ŠOG
2. JELIĆ, Milica 13U
3. SAVIĆ, Anđelija ASD



# REGIONALNO CS JUNIORI

Čačak, 22.03.2025.

JUNIORKE  
**-78KG**  
3 takmičarke

TAKMIČAR I KLUB	1	2	3	POBEDA	BODOVA	MESTO
1 CVETKOVIĆ, Ana Šogun, Niš		0	100	1	100	2
2 STOJKOVIĆ, Anastasija Kučevo, Kučevo	100		100	2	200	1
3 ĐORĐEVIĆ, Anđela Župa Aleksandrovac, Aleksandrovac	0	0		0	0	3

CVETKOVIĆ, Ana	ŠOG	1	STOJKOVIĆ, Anastasija
STOJKOVIĆ, Anastasija	KUČ		Kučevo, Kučevo
CVETKOVIĆ, Ana	ŠOG	2	CVETKOVIĆ, Ana
ĐORĐEVIĆ, Anđela	ŽAL		Šogun, Niš
STOJKOVIĆ, Anastasija	KUČ	3	STOJKOVIĆ, Anastasija
ĐORĐEVIĆ, Anđela	ŽAL		Kučevo, Kučevo

## Rezultati

1. STOJKOVIĆ, Anastasija KUČ
2. CVETKOVIĆ, Ana ŠOG
3. ĐORĐEVIĆ, Anđela ŽAL



# REGIONALNO CS JUNIORI

Čačak, 22.03.2025.

JUNIORKE  
**+78KG**  
2 takmičarke

ŠAINOVIC, Sara	BOR	1	ĐORĐEVIĆ, Teodora Goč, Vrnjačka Banja
ĐORĐEVIĆ, Teodora	GOČ		
ŠAINOVIC, Sara	BOR	2	ĐORĐEVIĆ, Teodora Goč, Vrnjačka Banja
ĐORĐEVIĆ, Teodora	GOČ		
ŠAINOVIC, Sara	BOR	3	
ĐORĐEVIĆ, Teodora	GOČ		

## Rezultati

1. ĐORĐEVIĆ, Teodora GOČ
2. ŠAINOVIC, Sara BOR