



REGIONALNO VOJVODINA M.DEČACI

Stepanovićevo, 22.03.2025.

MLAĐI DEČACI

-30KG

11 takmičara

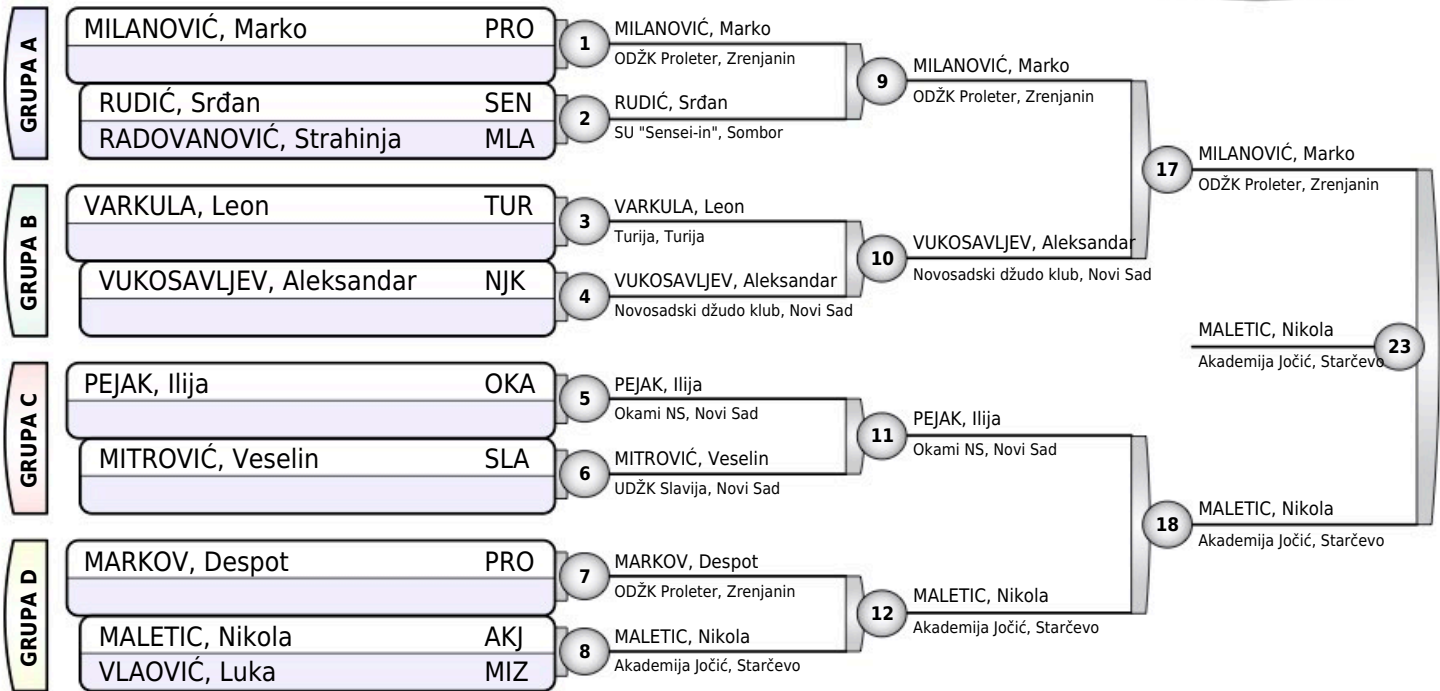

Rezultati

- MALETIC, Nikola AKJ
- MILANOVIĆ, Marko PRO
- PEJAK, Ilija OKA
- MARKOV, Despot PRO
- * VARKULA, Leon TUR
- VUKOSAVLJEV, Aleksandar NJK
- RUDIĆ, Srđan SEN
- MITROVIĆ, Veselin SLA

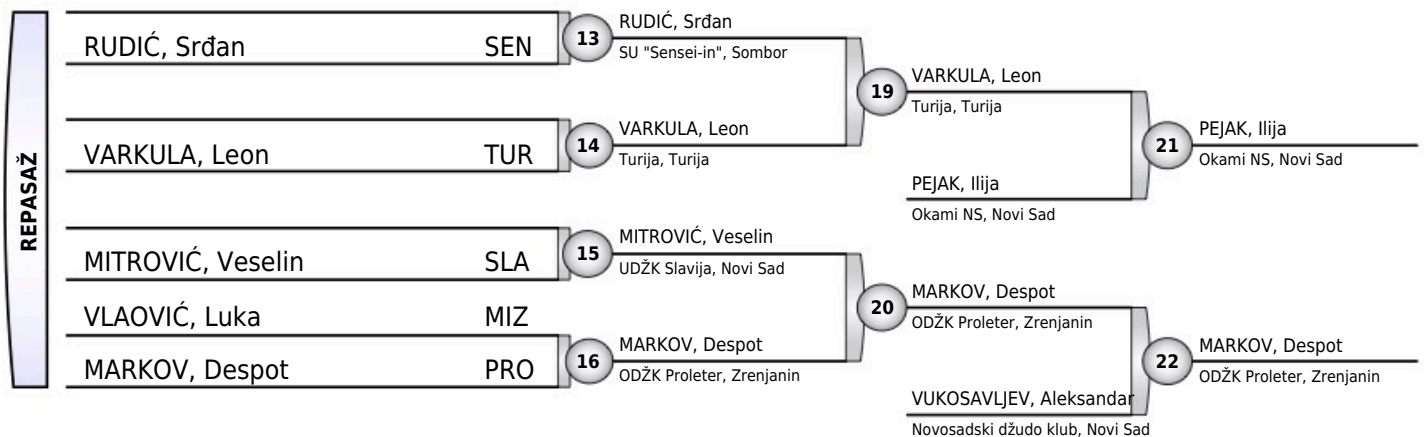



REGIONALNO VOJVODINA M.DEČACI

Stepanovićevo, 22.03.2025.

MLAĐI DEČACI

-34KG

21 takmičar

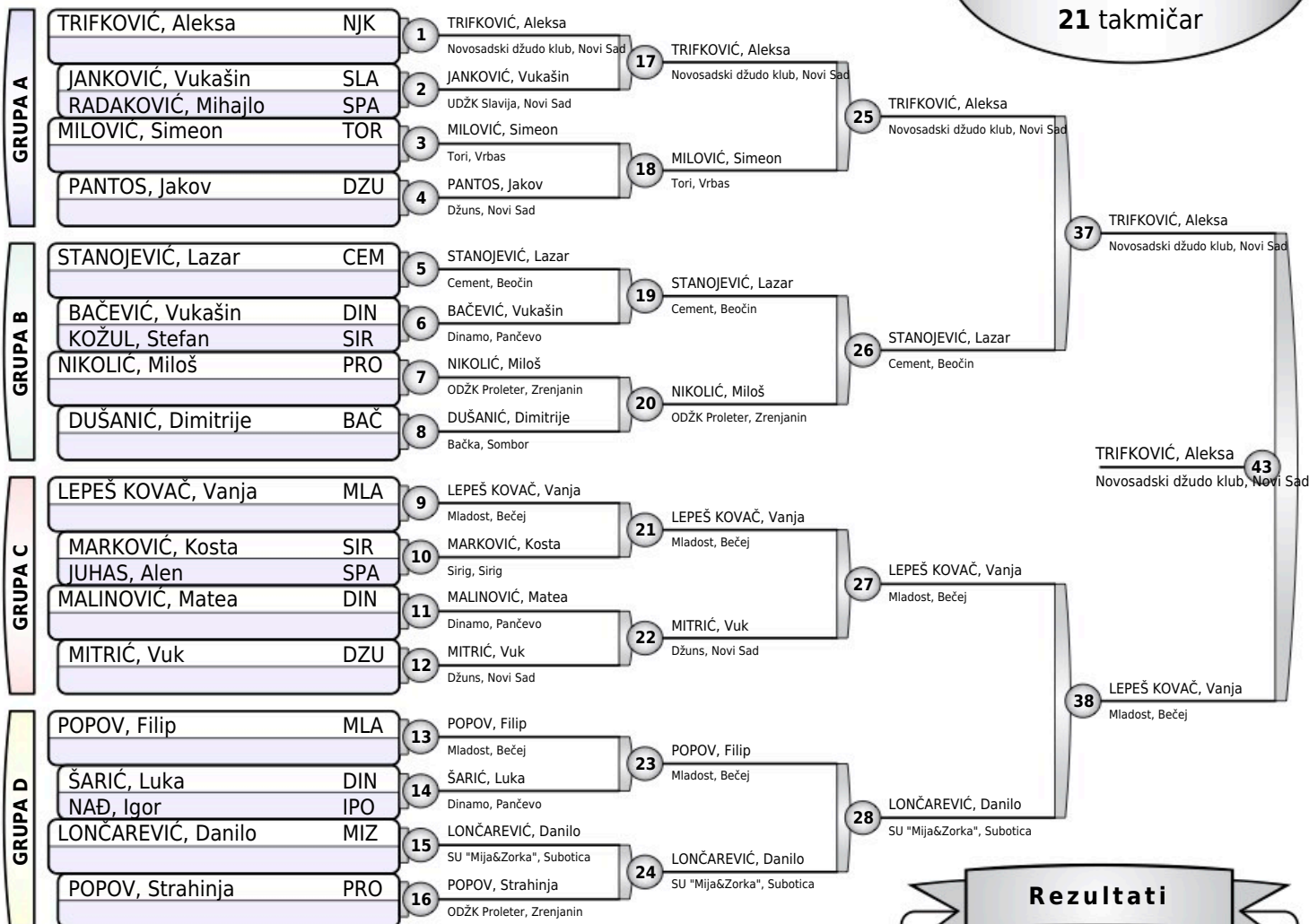

Rezultati

1. TRIFKOVIĆ, Aleksa NJK
2. LEPEŠ KOVAČ, Vanja MLA
3. LONČAREVIĆ, Danilo MIZ
3. POPOV, Filip MLA
5. BAČEVIĆ, Vukašin DIN
- * 5. STANOJEVIĆ, Lazar CEM
7. MILOVIĆ, Simeon TOR
7. MITRIĆ, Vuk DZU

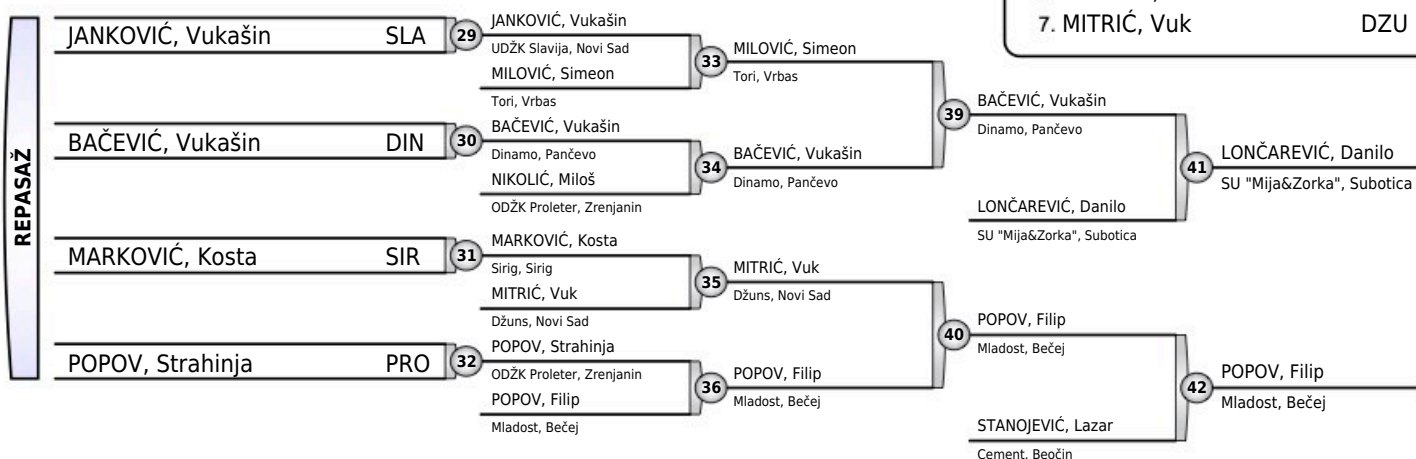



REGIONALNO VOJVODINA M.DEČACI

Stepanovićevo, 22.03.2025.

MLAĐI DEČACI

-38KG

23 takmičara

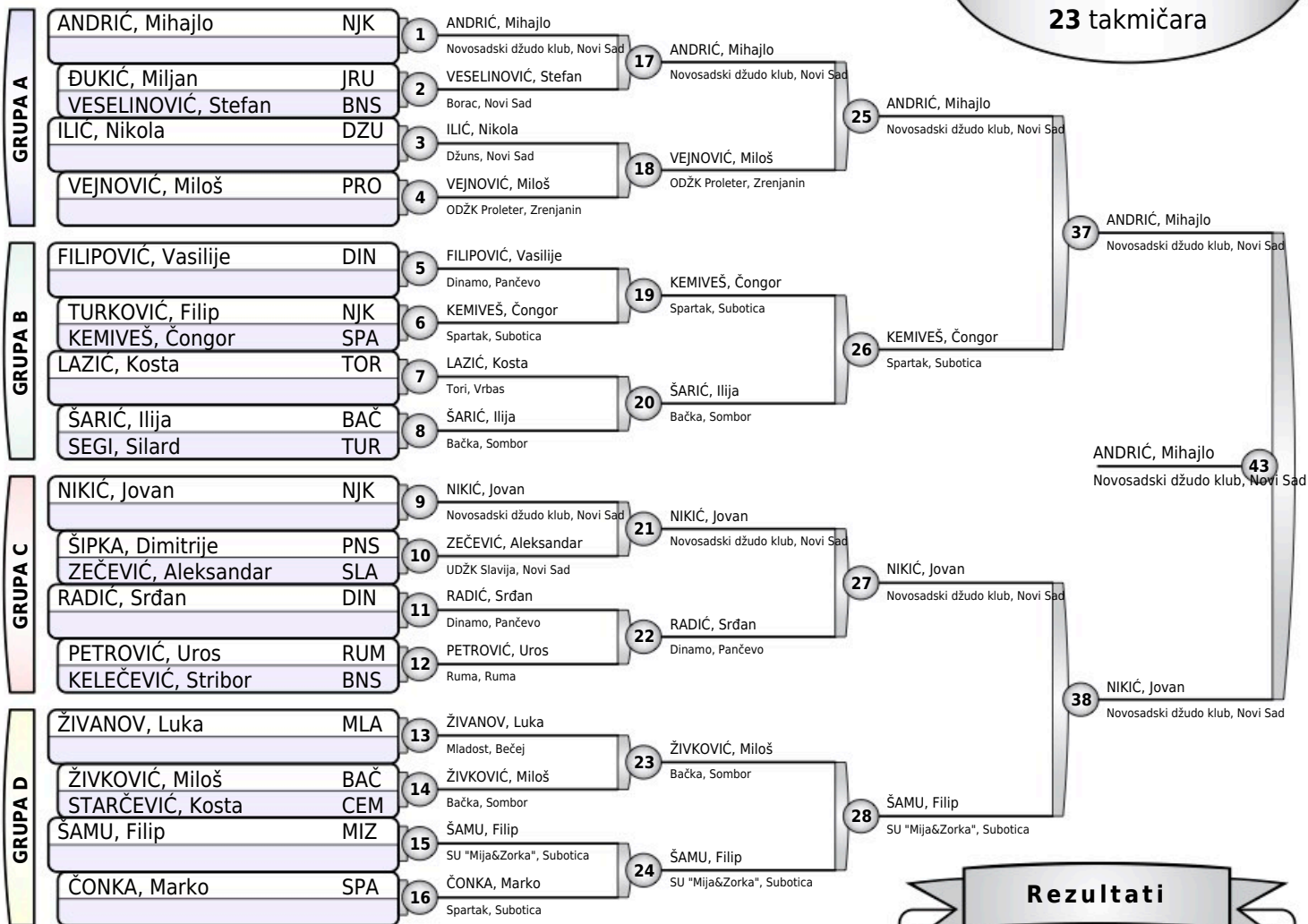

Rezultati

1. ANDRIĆ, Mihajlo NJK
2. NIKIĆ, Jovan NJK
3. ŠAMU, Filip MIZ
3. KEMIVEŠ, Čongor SPA
5. VEJNOVIĆ, Miloš PRO
- * 5. ZEČEVIĆ, Aleksandar SLA
7. ŠARIĆ, Ilija BAČ
7. ŽIVKOVIĆ, Miloš BAČ

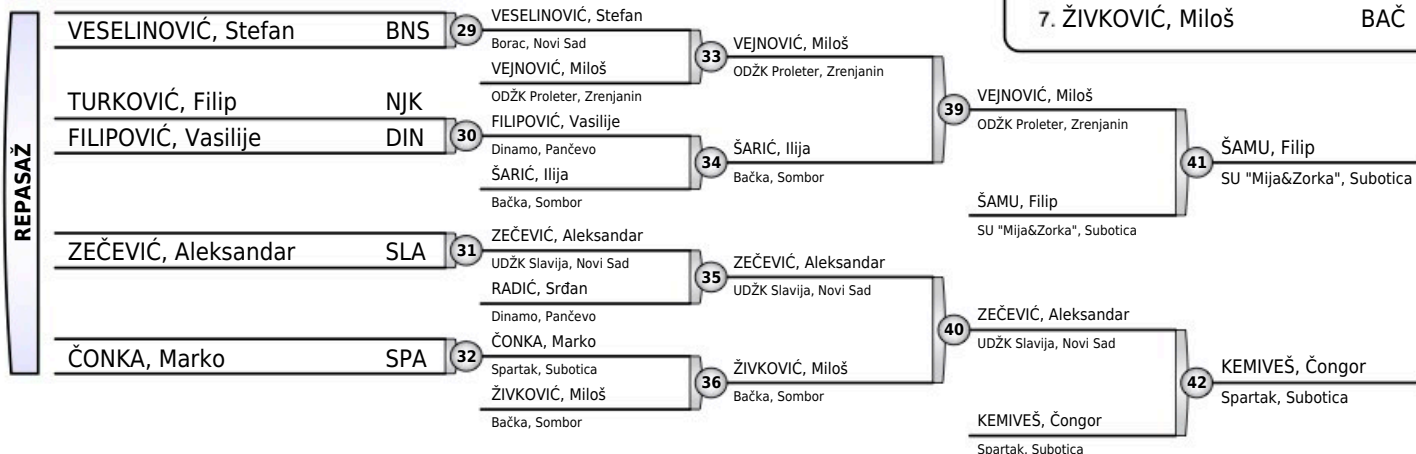



REGIONALNO VOJVODINA M.DEČACI

Stepanovićevo, 22.03.2025.

MLAĐI DEČACI

-42KG

15 takmičara

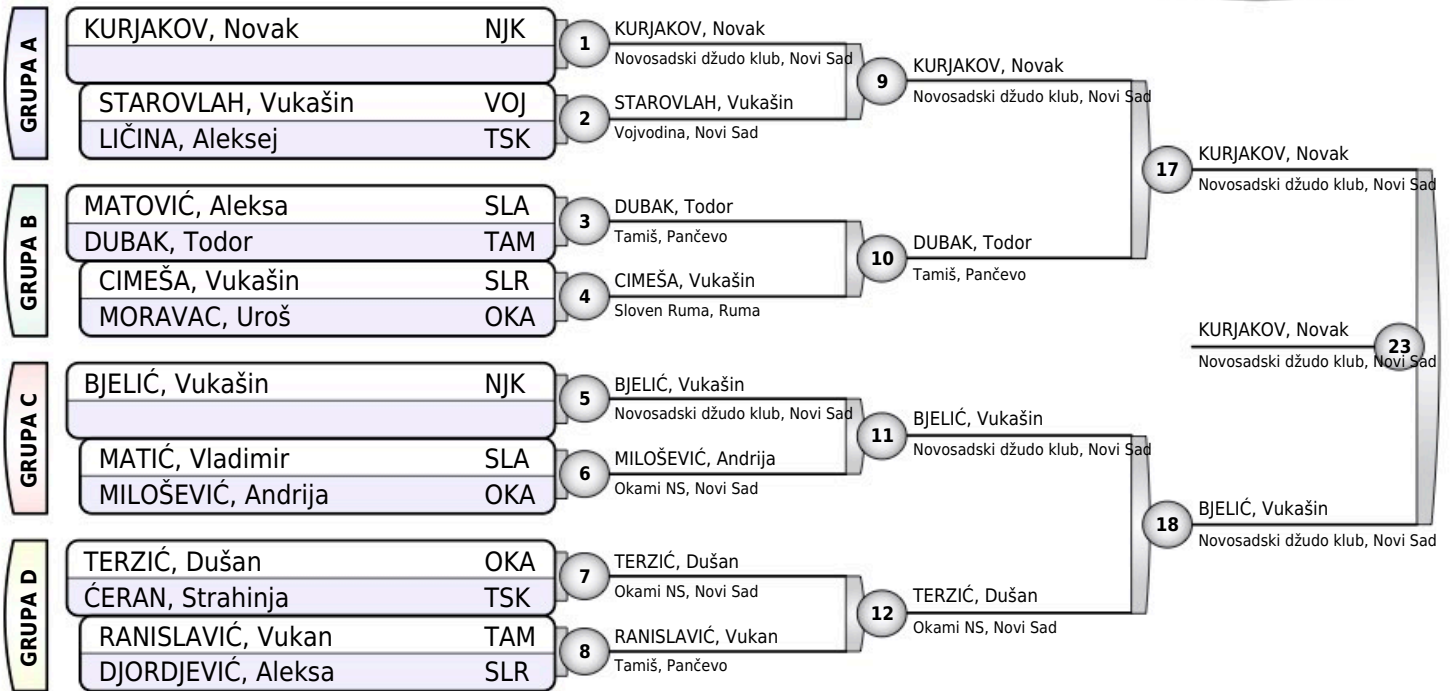

Rezultati

1. KURJAKOV, Novak NJK
2. BJELIĆ, Vukašin NJK
3. TERZIĆ, Dušan OKA
3. DUBAK, Todor TAM
- * 5. MATOVIĆ, Aleksa SLA
5. MILOŠEVIĆ, Andrija OKA
7. STAROVLAH, Vukašin VOJ
7. RANISLAVIĆ, Vukan TAM

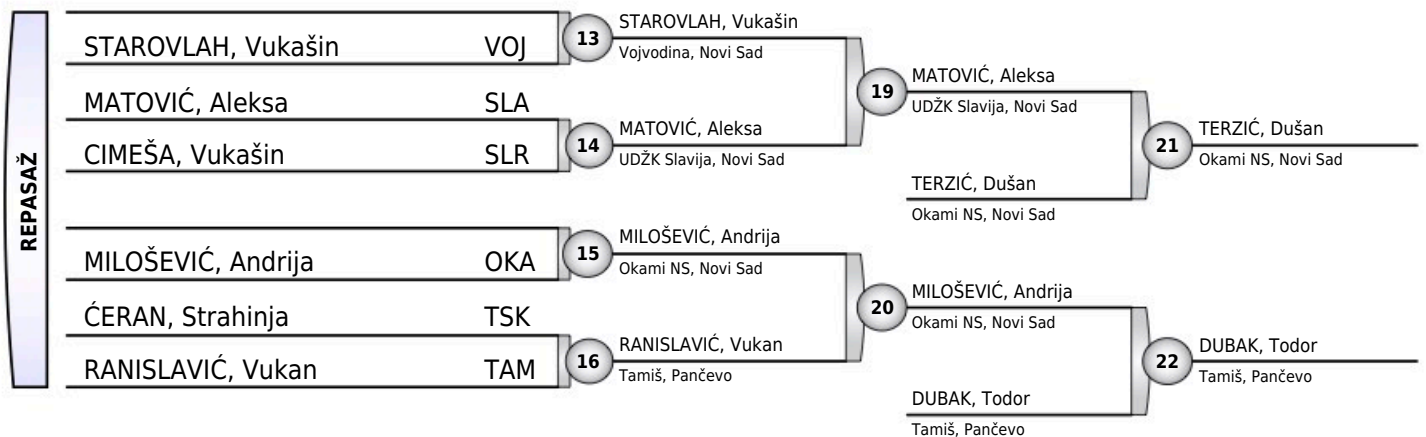



REGIONALNO VOJVODINA M.DEČACI

Stepanovićevo, 22.03.2025.

MLAĐI DEČACI

-46KG

24 takmičara

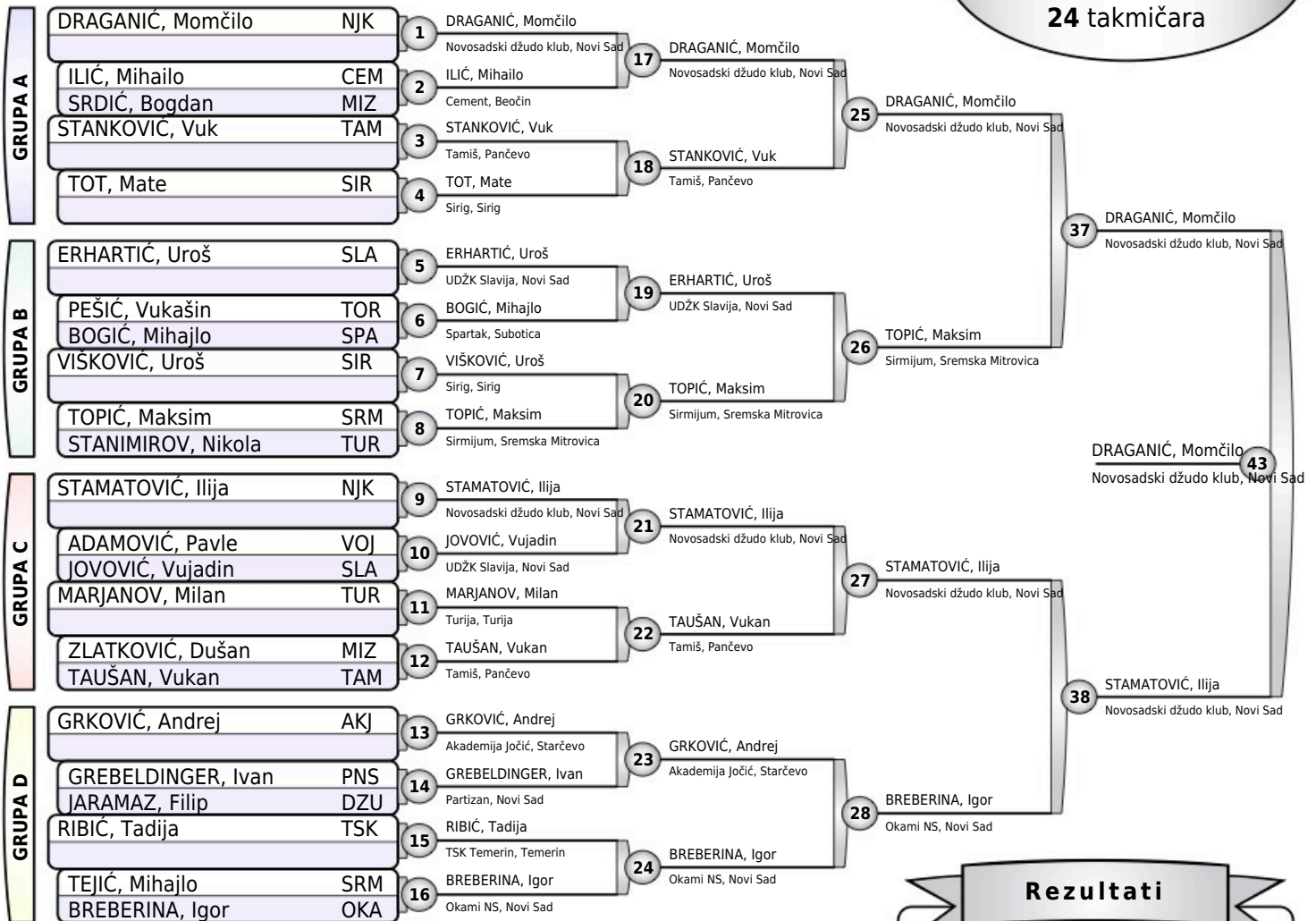

Rezultati

- DRAGANIĆ, Momčilo NJK
- STAMATOVIĆ, Ilija NJK
- ERHARTIĆ, Uroš SLA
- TOPIĆ, Maksim SRM
- * BREBERINA, Igor OKA
- GRKOVIĆ, Andrej AKJ
- STANKOVIĆ, Vuk TAM
- TAUŠAN, Vukan TAM

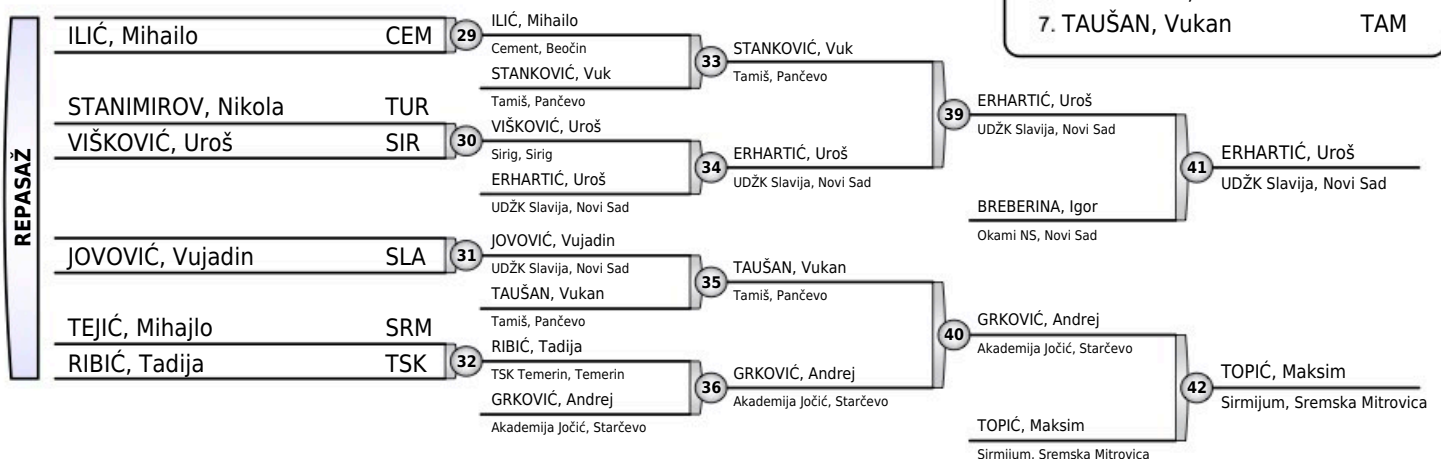



REGIONALNO VOJVODINA M.DEČACI

Stepanovićevo, 22.03.2025.

MLAĐI DEČACI

-50KG

13 takmičara

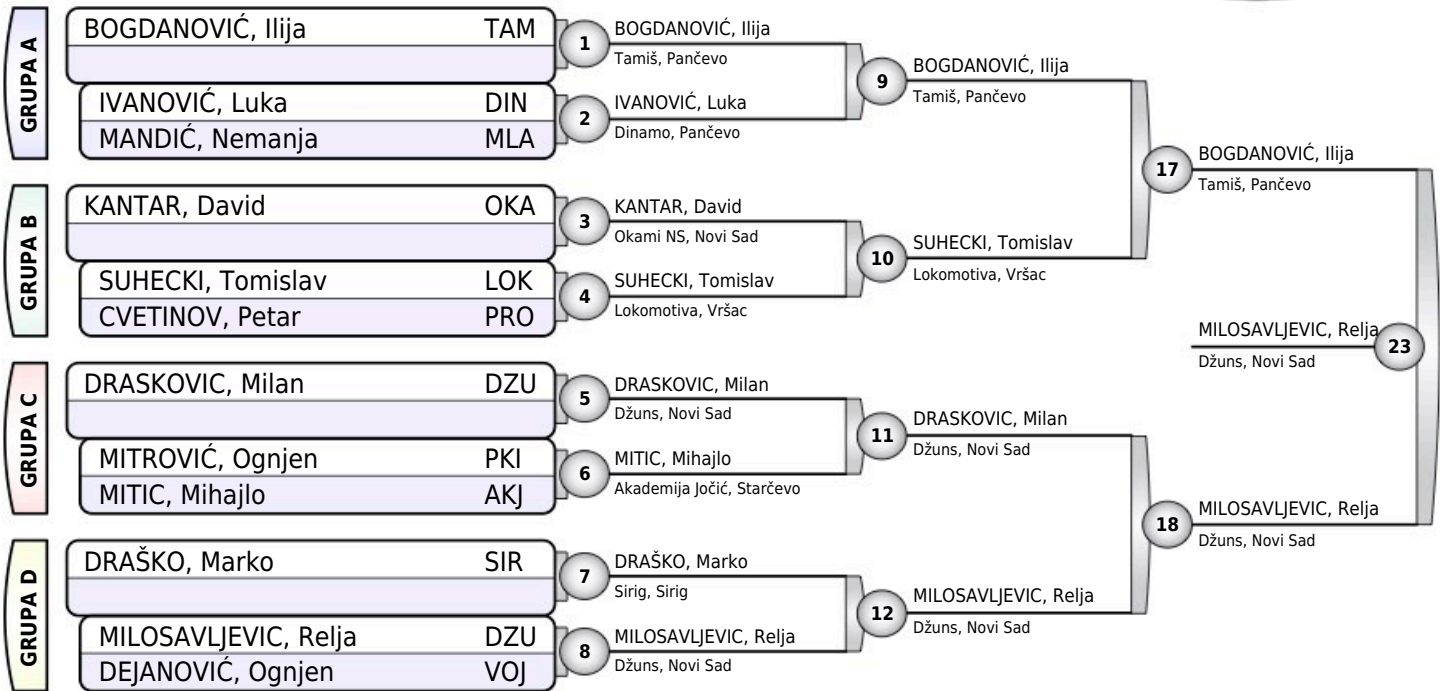

Rezultati

1. MILOSAVLJEVIC, Relja DZU
2. BOGDANOVIĆ, Ilija TAM
3. DRASKOVIC, Milan DZU
3. SUHECKI, Tomislav LOK
5. IVANOVIĆ, Luka DIN
- * 5. DEJANOVIĆ, Ognjen VOJ
7. KANTAR, David OKA
7. MITIC, Mihajlo AKJ

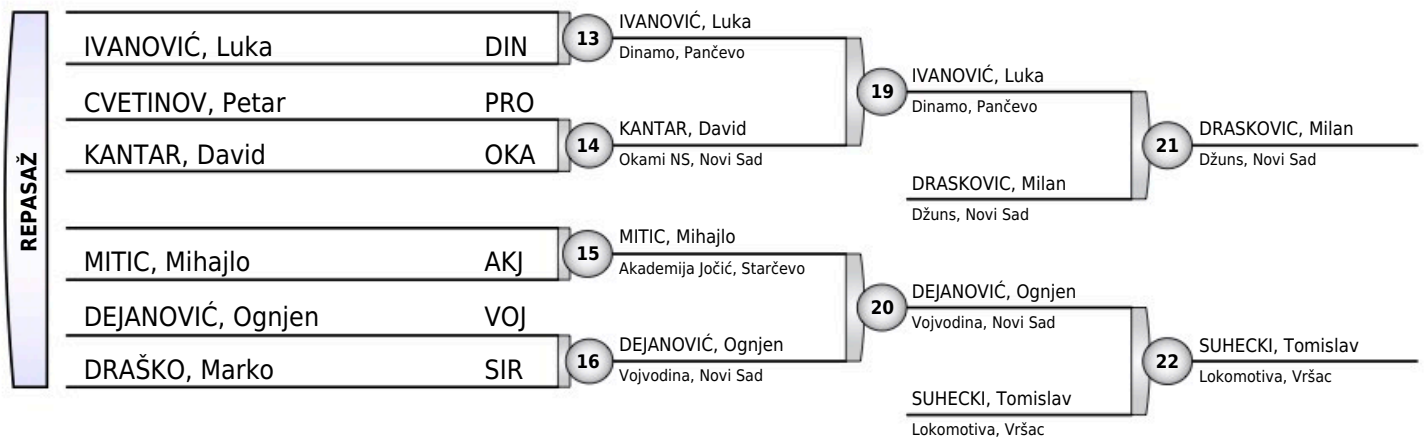



REGIONALNO VOJVODINA M.DEČACI

Stepanovićevo, 22.03.2025.

MLAĐI DEČACI

-55KG

8 takmičara

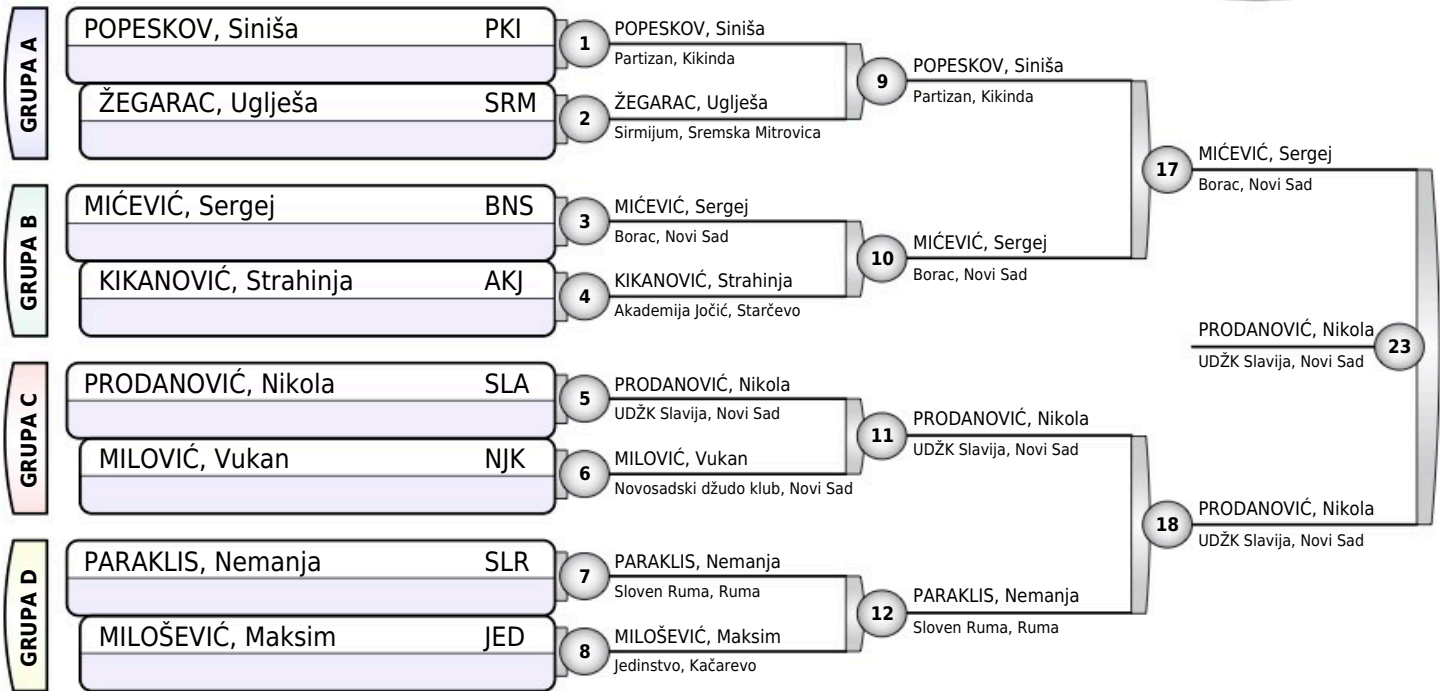

Rezultati

1. PRODANOVIĆ, Nikola SLA
2. MIĆEVIĆ, Sergej BNS
3. ŽEGARAC, Uglješa SRM
3. POPEŠKOV, Siniša PKI
5. PARAKLIS, Nemanja SLR
5. MILOŠEVIĆ, Maksim JED
7. KIKANOVIĆ, Strahinja AKJ
7. MILOVIĆ, Vukan NJK

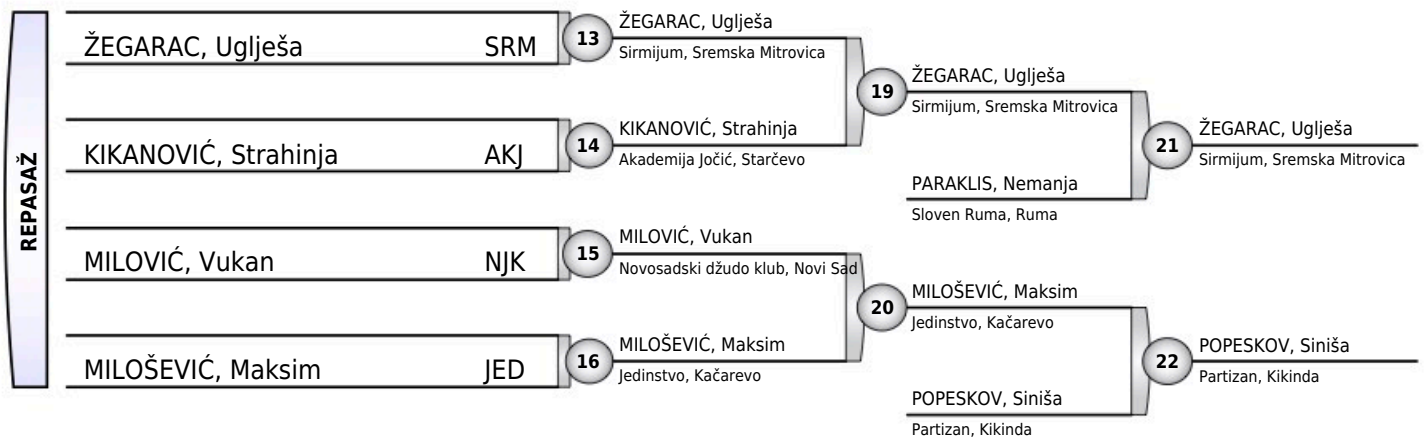



REGIONALNO VOJVODINA M.DEČACI

Stepanovićevo, 22.03.2025.

MLAĐI DEČACI

-60KG

11 takmičara

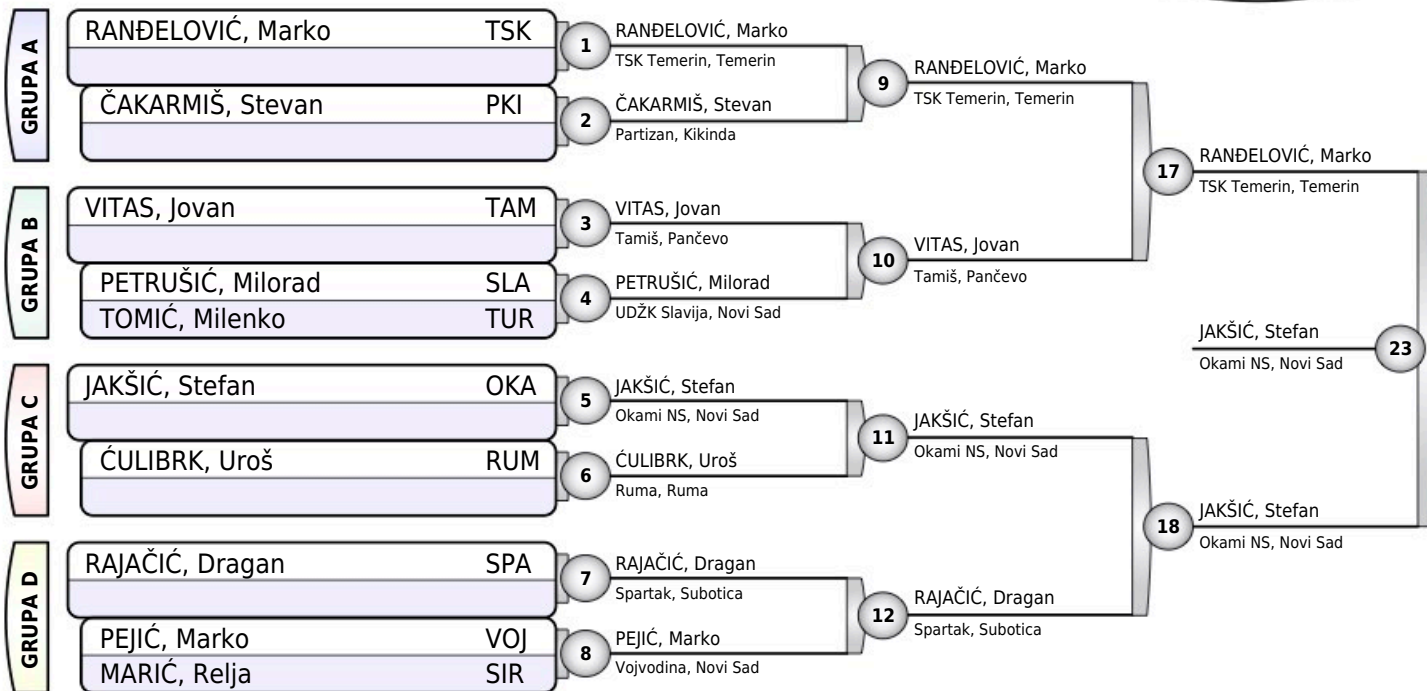

Rezultati

1. JAKŠIĆ, Stefan OKA
2. RANĐELOVIĆ, Marko TSK
3. RAJAČIĆ, Dragan SPA
3. VITAS, Jovan TAM
- * 5. PETRUŠIĆ, Milorad SLA
5. PEJIĆ, Marko VOJ
7. ČAKARMIŠ, Stevan PKI
7. ĆULIBRK, Uroš RUM

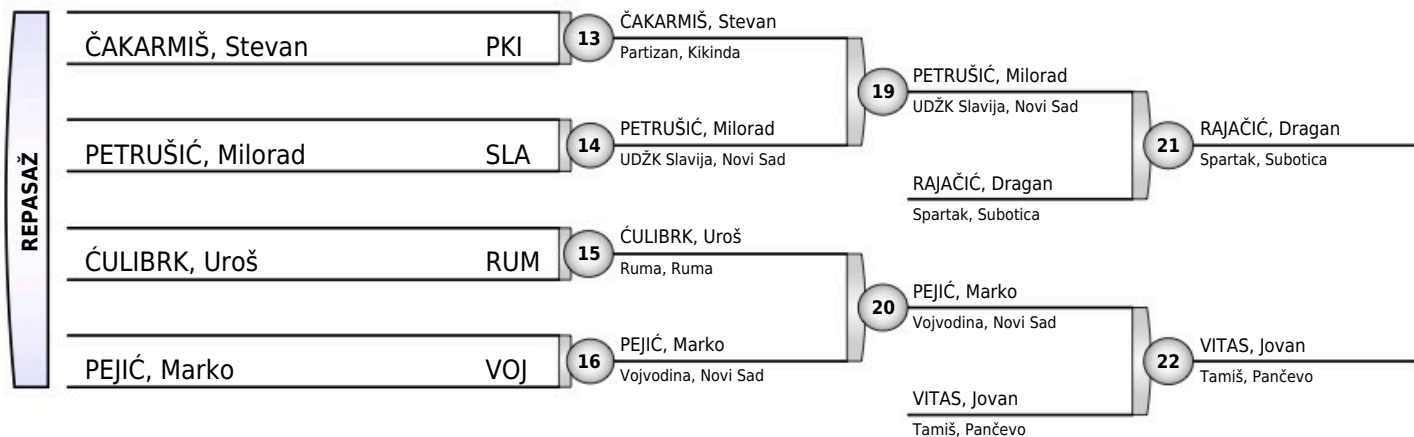



REGIONALNO VOJVODINA M.DEČACI

Stepanovićevo, 22.03.2025.

MLAĐI DEČACI

-66KG

3 takmičara

TAKMIČAR I KLUB	1	2	3	POBEDA	BODOVA	MESTO
1 MATARIĆ, Andrija Ipon, Sombor		100	100	2	200	1
2 LAZIĆ, Živan Sirmijum, Sremska Mitrovica	0		100	1	100	2
3 MRAOVIĆ, Marko Ipon, Sombor	0	0		0	0	3

MATARIĆ, Andrija	IPO	1	MATARIĆ, Andrija
LAZIĆ, Živan	SRM		Ipon, Sombor
MATARIĆ, Andrija	IPO	2	MATARIĆ, Andrija
MRAOVIĆ, Marko	IPO		Ipon, Sombor
LAZIĆ, Živan	SRM	3	LAZIĆ, Živan
MRAOVIĆ, Marko	IPO		Sirmijum, Sremska Mitrovica

Rezultati

1. MATARIĆ, Andrija IPO
2. LAZIĆ, Živan SRM
3. MRAOVIĆ, Marko IPO



REGIONALNO VOJVODINA M.DEČACI

Stepanovićevo, 22.03.2025.

MLAĐI DEČACI

+66KG

5 takmičara

TAKMIČAR I KLUB	1	2	3	4	5	POBEDA	BODOVA	MESTO
1 MILINKOVIĆ, Petar Cement, Beočin		0	0	100	0	1	100	3
2 GLOZIK, Ivan Jedinstvo, Kačarevo	100		100	100	100	4	400	1
3 GAGOVIĆ, Mirko ODŽK Proleter, Zrenjanin	100	0		100	0	2	200	3
4 PAUNOSKI, Maksim ODŽK Proleter, Zrenjanin	0	0	0		0	0	0	5
5 ČIGOJA, Radan Akademija Jočić, Starčevo	100	0	100	100		3	300	2

MILINKOVIĆ, Petar	CEM	1	GLOZIK, Ivan
GLOZIK, Ivan	JED		Jedinstvo, Kačarevo
GAGOVIĆ, Mirko	PRO	2	GAGOVIĆ, Mirko
PAUNOSKI, Maksim	PRO		ODŽK Proleter, Zrenjanin
MILINKOVIĆ, Petar	CEM	3	ČIGOJA, Radan
ČIGOJA, Radan	AKJ		Akademija Jočić, Starčevo
GLOZIK, Ivan	JED	4	GLOZIK, Ivan
GAGOVIĆ, Mirko	PRO		Jedinstvo, Kačarevo
PAUNOSKI, Maksim	PRO	5	ČIGOJA, Radan
ČIGOJA, Radan	AKJ		Akademija Jočić, Starčevo
MILINKOVIĆ, Petar	CEM	6	GAGOVIĆ, Mirko
GAGOVIĆ, Mirko	PRO		ODŽK Proleter, Zrenjanin
GLOZIK, Ivan	JED	7	GLOZIK, Ivan
PAUNOSKI, Maksim	PRO		Jedinstvo, Kačarevo
GAGOVIĆ, Mirko	PRO	8	ČIGOJA, Radan
ČIGOJA, Radan	AKJ		Akademija Jočić, Starčevo
MILINKOVIĆ, Petar	CEM	9	MILINKOVIĆ, Petar
PAUNOSKI, Maksim	PRO		Cement, Beočin
GLOZIK, Ivan	JED	10	GLOZIK, Ivan
ČIGOJA, Radan	AKJ		Jedinstvo, Kačarevo

Rezultati

- | | |
|----------------------|-----|
| 1. GLOZIK, Ivan | JED |
| 2. ČIGOJA, Radan | AKJ |
| 3. GAGOVIĆ, Mirko | PRO |
| 3. MILINKOVIĆ, Petar | CEM |
| 5. PAUNOSKI, Maksim | PRO |



REGIONALNO VOJVODINA M.DEČACI

Stepanovićevo, 22.03.2025.

MLAĐE DEVOJČICE

-32KG

11 takmičarki

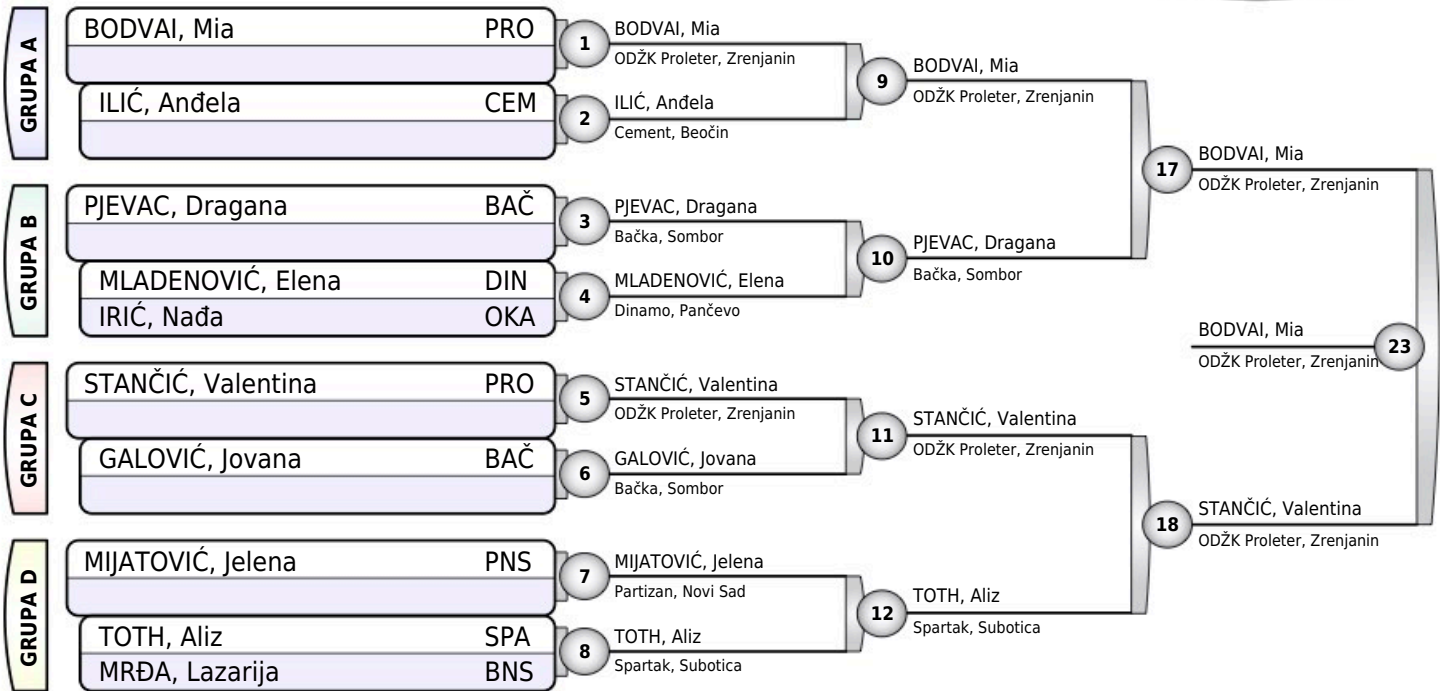

Rezultati

1. BODVAI, Mia PRO
2. STANČIĆ, Valentina PRO
3. TOTH, Aliz SPA
3. MIJATOVIĆ, Jelena PNS
- * 5. ILIĆ, Anđela CEM
7. MLADENOVIĆ, Elena DIN
7. GALOVIĆ, Jovana BAČ

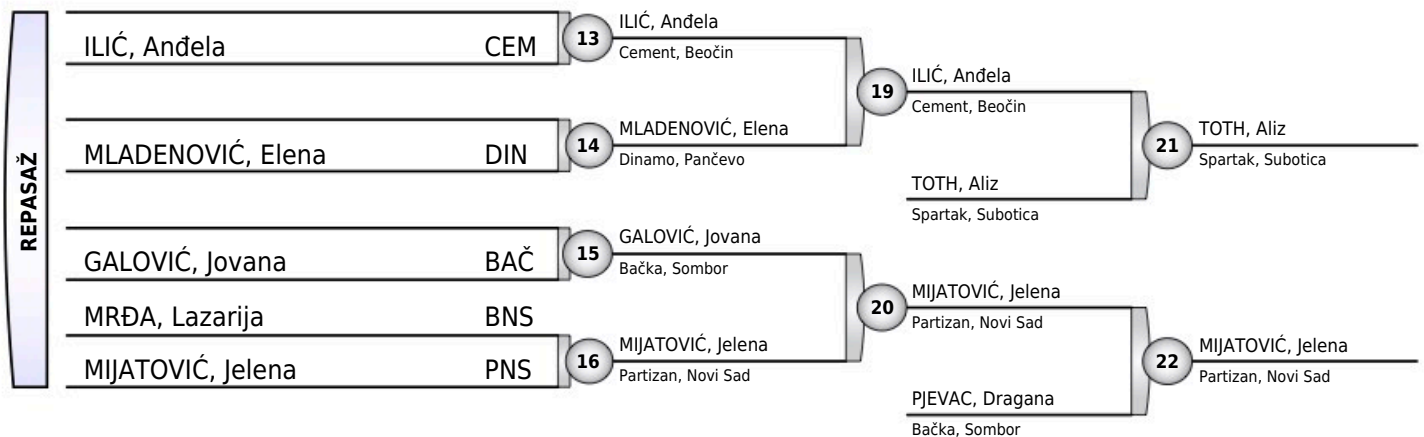



REGIONALNO VOJVODINA M.DEČACI

Stepanovićevo, 22.03.2025.

MLAĐE DEVOJČICE

-36KG

9 takmičarki

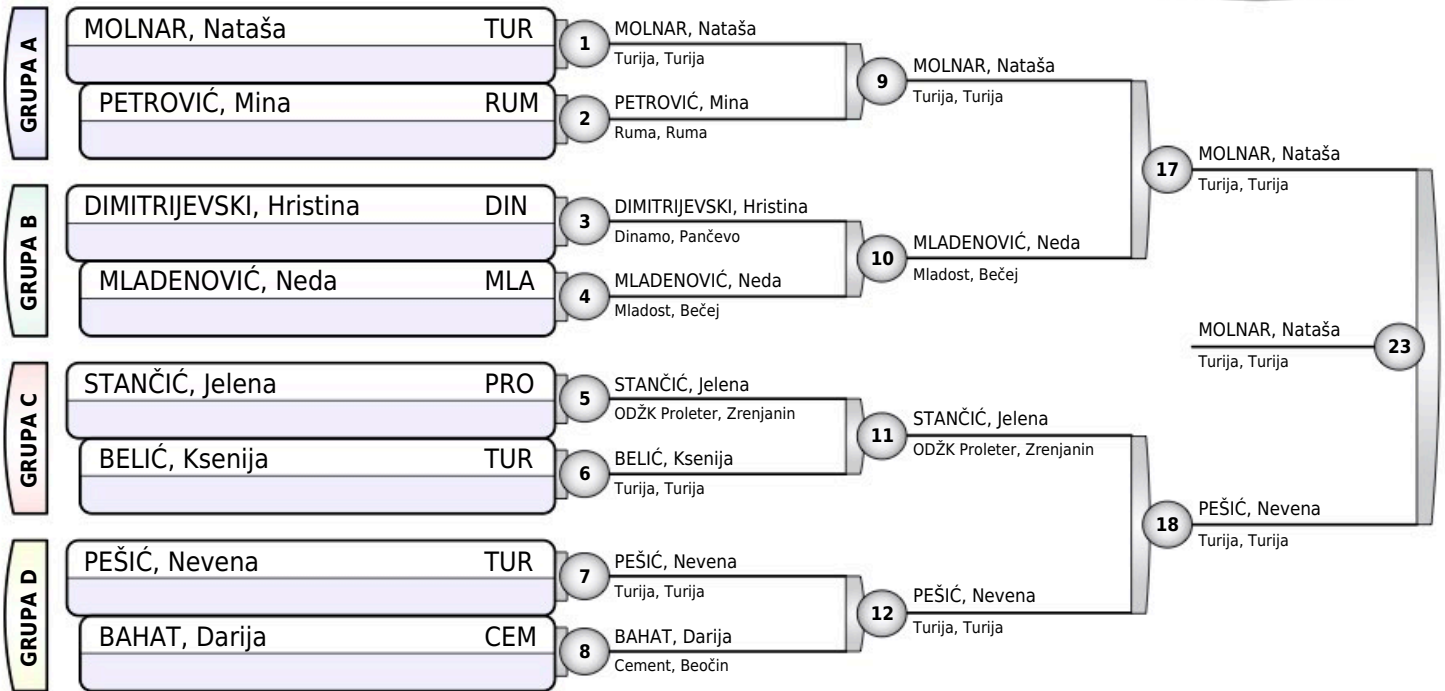

Rezultati

1. MOLNAR, Nataša TUR
2. PEŠIĆ, Nevena TUR
3. STANČIĆ, Jelena PRO
3. BAHAT, Darija CEM
5. DIMITRIJEVSKI, Hristina DIN
5. MLADENOVIĆ, Neda MLA
7. PETROVIĆ, Mina RUM
- * 7. BELIĆ, Ksenija TUR

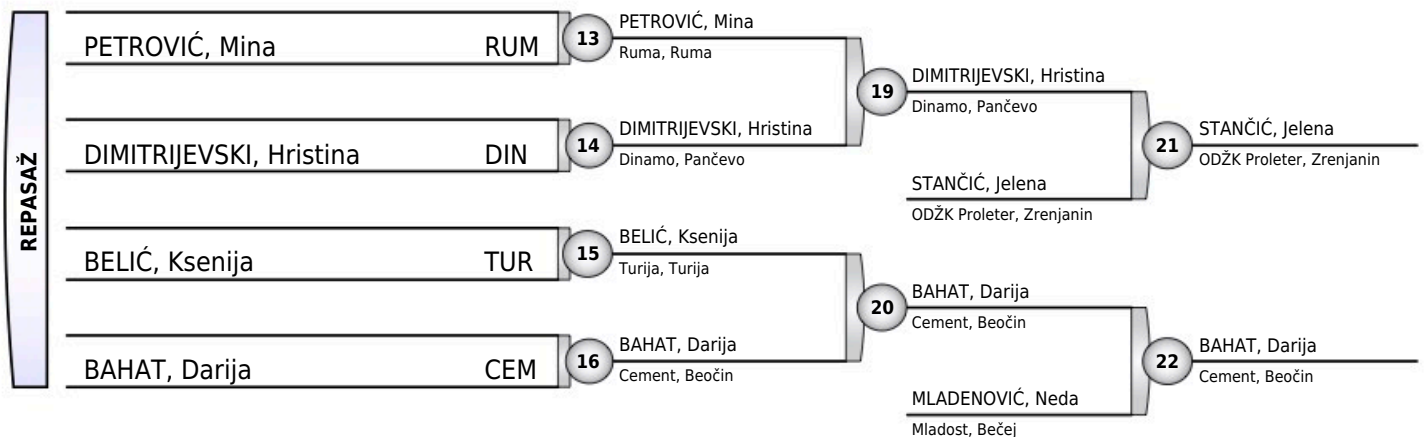



REGIONALNO VOJVODINA M.DEČACI

Stepanovićevo, 22.03.2025.

MLAĐE DEVOJČICE

-40KG

15 takmičarki

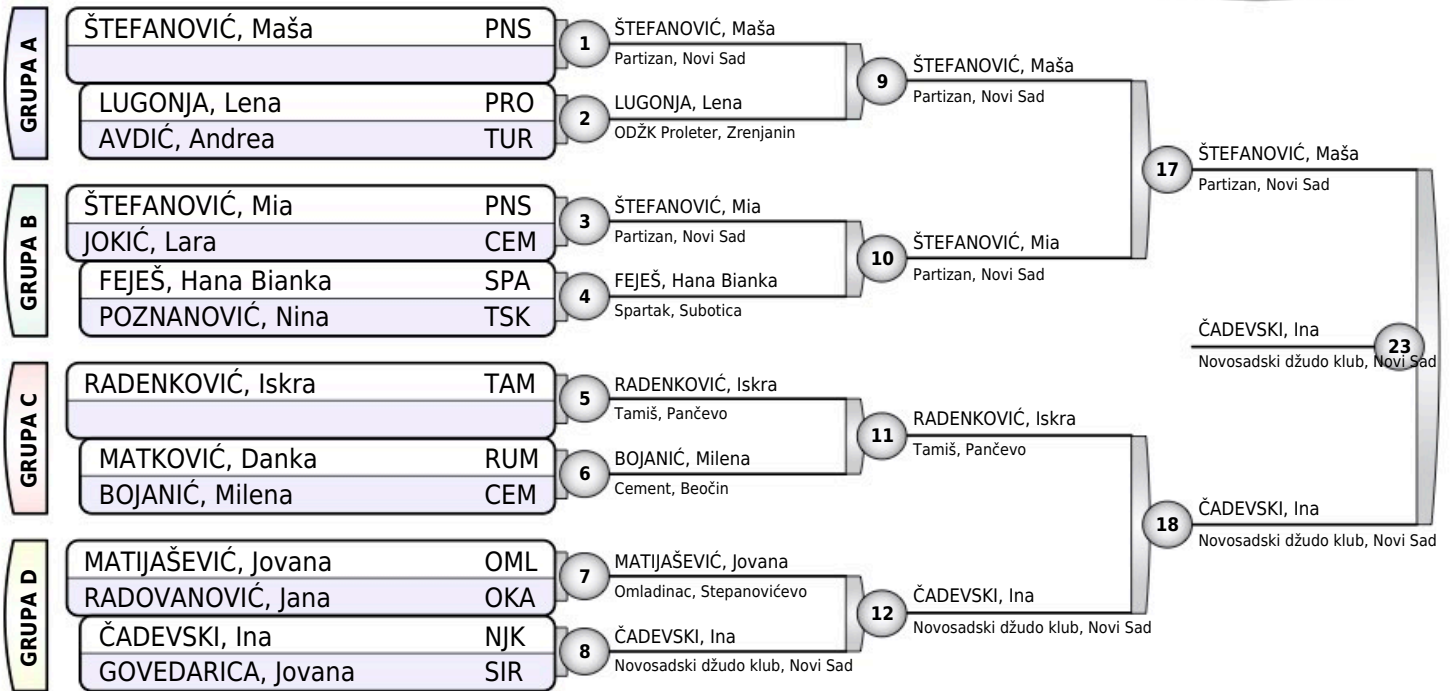

Rezultati

1. ČADEVSKI, Ina NJK
2. ŠTEFANOVIĆ, Maša PNS
3. RADENKOVIĆ, Iskra TAM
3. ŠTEFANOVIĆ, Mia PNS
5. FEJEŠ, Hana Bianka SPA
5. GOVEDARICA, Jovana SIR
7. LUGONJA, Lena PRO
- * 7. BOJANIĆ, Milena CEM

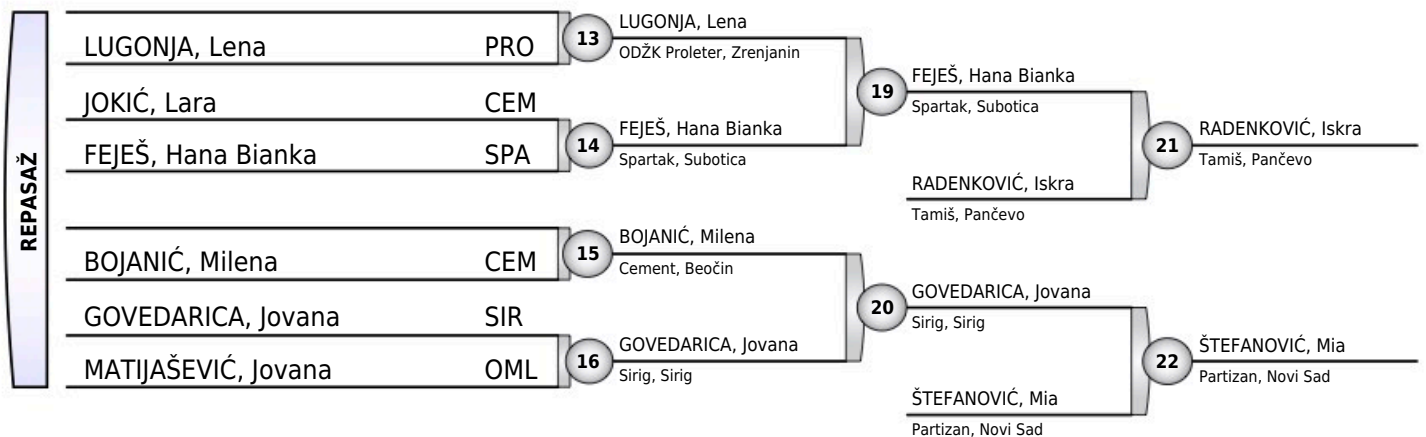



REGIONALNO VOJVODINA M.DEČACI

Stepanovićevo, 22.03.2025.

MLAĐE DEVOJČICE

-44KG

11 takmičarki

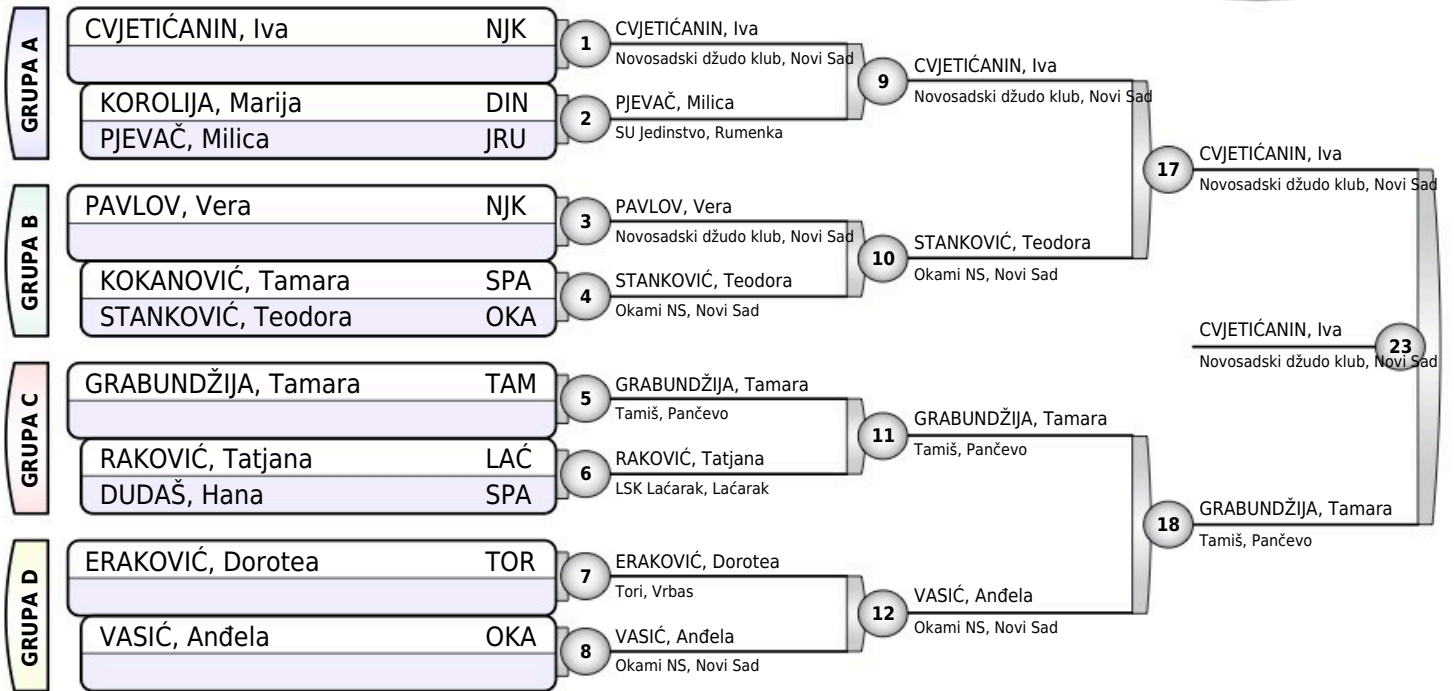

Rezultati

1. CVJETIĆANIN, Iva NJK
2. GRABUNDŽIJA, Tamara TAM
3. PJEVAČ, Milica JRU
3. RAKOVIĆ, Tatjana LAĆ
5. VASIĆ, Anđela OKA
5. STANKOVIĆ, Teodora OKA
7. PAVLOV, Vera NJK
7. ERAKOVIĆ, Dorotea TOR

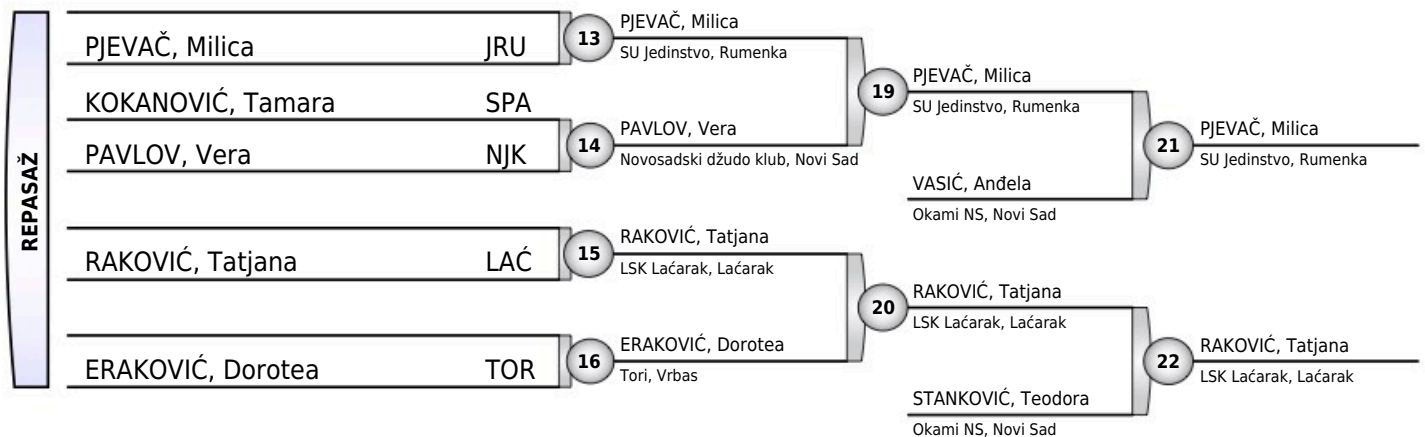



REGIONALNO VOJVODINA M.DEČACI

Stepanovićevo, 22.03.2025.

MLAĐE DEVOJČICE

-48KG

8 takmičarki

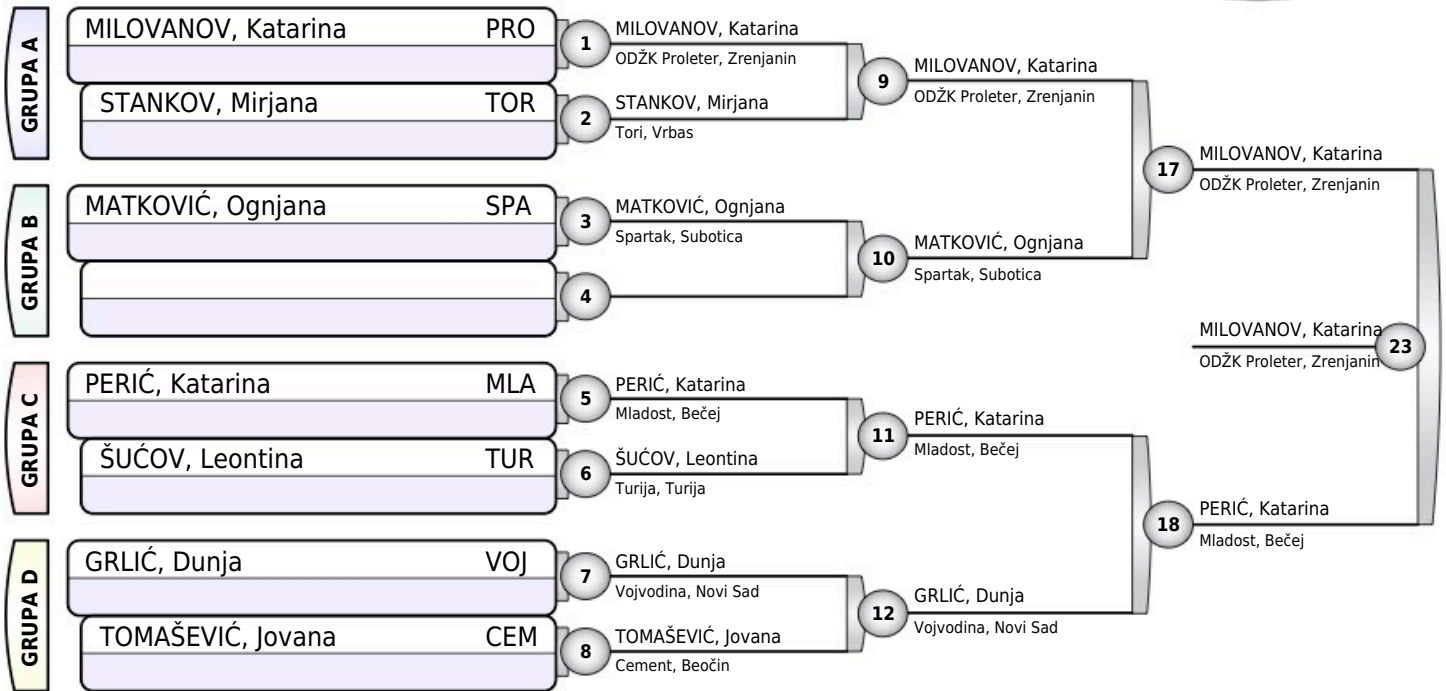

Rezultati

1. MILOVANOV, Katarina PRO
2. PERIĆ, Katarina MLA
3. GRLIĆ, Dunja VOJ
3. ŠUĆOV, Leontina TUR
5. STANKOV, Mirjana TOR
- * 5. MATKOVIĆ, Ognjana SPA
7. TOMAŠEVIĆ, Jovana CEM
- 7.

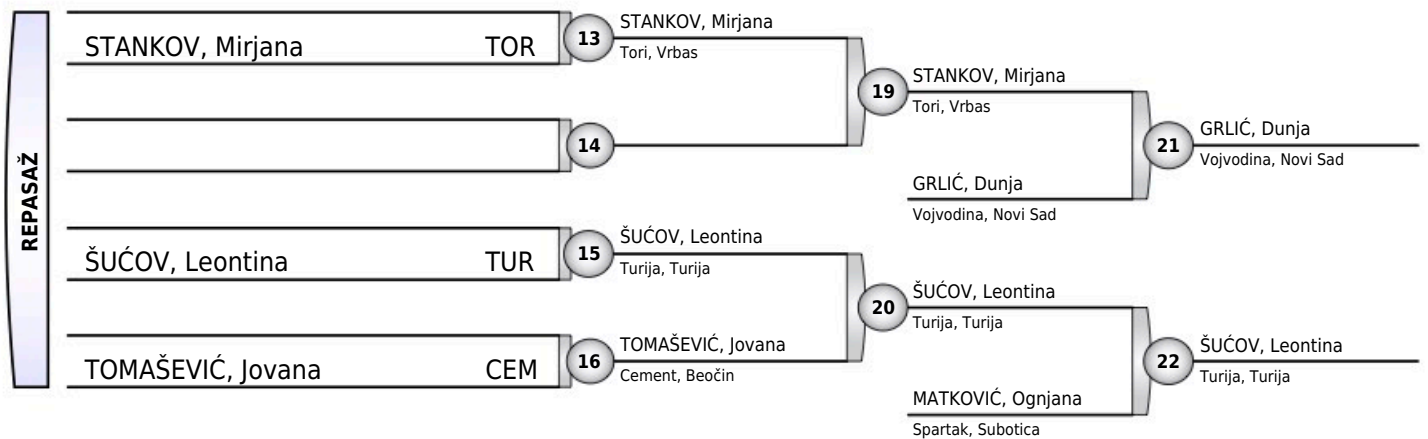



REGIONALNO VOJVODINA M.DEČACI

Stepanovićevo, 22.03.2025.

MLAĐE DEVOJČICE

-52KG

5 takmičarki

TAKMIČAR I KLUB	1	2	3	4	5	POBEDA	BODOVA	MESTO
1 UNGUR, Talia ODŽK Proleter, Zrenjanin		0	0	0	0	0	0	5
2 GARIĆ, Ksenija UDŽK Slavija, Novi Sad	100		100	100	100	4	400	1
3 RANČIĆ, Lena Tamiš, Pančevo	100	0		100	0	2	200	3
4 CVJETIĆANIN, Lara Novosadski džudo klub, Novi Sad	100	0	0		100	2	200	2
5 MARTINČEVIĆ, Anja Omladinac, Stepanovićevo	100	0	100	0		2	200	3

UNGUR, Talia	PRO	1	GARIĆ, Ksenija
GARIĆ, Ksenija	SLA		UDŽK Slavija, Novi Sad
RANČIĆ, Lena	TAM	2	RANČIĆ, Lena
CVJETIĆANIN, Lara	NJK		Tamiš, Pančevo
UNGUR, Talia	PRO	3	MARTINČEVIĆ, Anja
MARTINČEVIĆ, Anja	OML		Omladinac, Stepanovićevo
GARIĆ, Ksenija	SLA	4	GARIĆ, Ksenija
RANČIĆ, Lena	TAM		UDŽK Slavija, Novi Sad
CVJETIĆANIN, Lara	NJK	5	CVJETIĆANIN, Lara
MARTINČEVIĆ, Anja	OML		Novosadski džudo klub, Novi Sad
UNGUR, Talia	PRO	6	RANČIĆ, Lena
RANČIĆ, Lena	TAM		Tamiš, Pančevo
GARIĆ, Ksenija	SLA	7	GARIĆ, Ksenija
CVJETIĆANIN, Lara	NJK		UDŽK Slavija, Novi Sad
RANČIĆ, Lena	TAM	8	MARTINČEVIĆ, Anja
MARTINČEVIĆ, Anja	OML		Omladinac, Stepanovićevo
UNGUR, Talia	PRO	9	CVJETIĆANIN, Lara
CVJETIĆANIN, Lara	NJK		Novosadski džudo klub, Novi Sad
GARIĆ, Ksenija	SLA	10	GARIĆ, Ksenija
MARTINČEVIĆ, Anja	OML		UDŽK Slavija, Novi Sad

Rezultati

- | | |
|----------------------|-----|
| 1. GARIĆ, Ksenija | SLA |
| 2. CVJETIĆANIN, Lara | NJK |
| 3. MARTINČEVIĆ, Anja | OML |
| 3. RANČIĆ, Lena | TAM |
| 5. UNGUR, Talia | PRO |



REGIONALNO VOJVODINA M.DEČACI

Stepanovićevo, 22.03.2025.

MLAĐE DEVOJČICE

-56KG

2 takmičarke

MILOSAVLJEVIĆ, Mia	TUR	1	MILOSAVLJEVIĆ, Mia Turija, Turija
ILIĆ, Emilija	TAM		
MILOSAVLJEVIĆ, Mia	TUR	2	MILOSAVLJEVIĆ, Mia Turija, Turija
ILIĆ, Emilija	TAM		
MILOSAVLJEVIĆ, Mia	TUR	3	
ILIĆ, Emilija	TAM		

Rezultati

1. MILOSAVLJEVIĆ, Mia TUR
2. ILIĆ, Emilija TAM



REGIONALNO VOJVODINA M.DEČACI

Stepanovićevo, 22.03.2025.

MLAĐE DEVOJČICE

+56KG

10 takmičarki

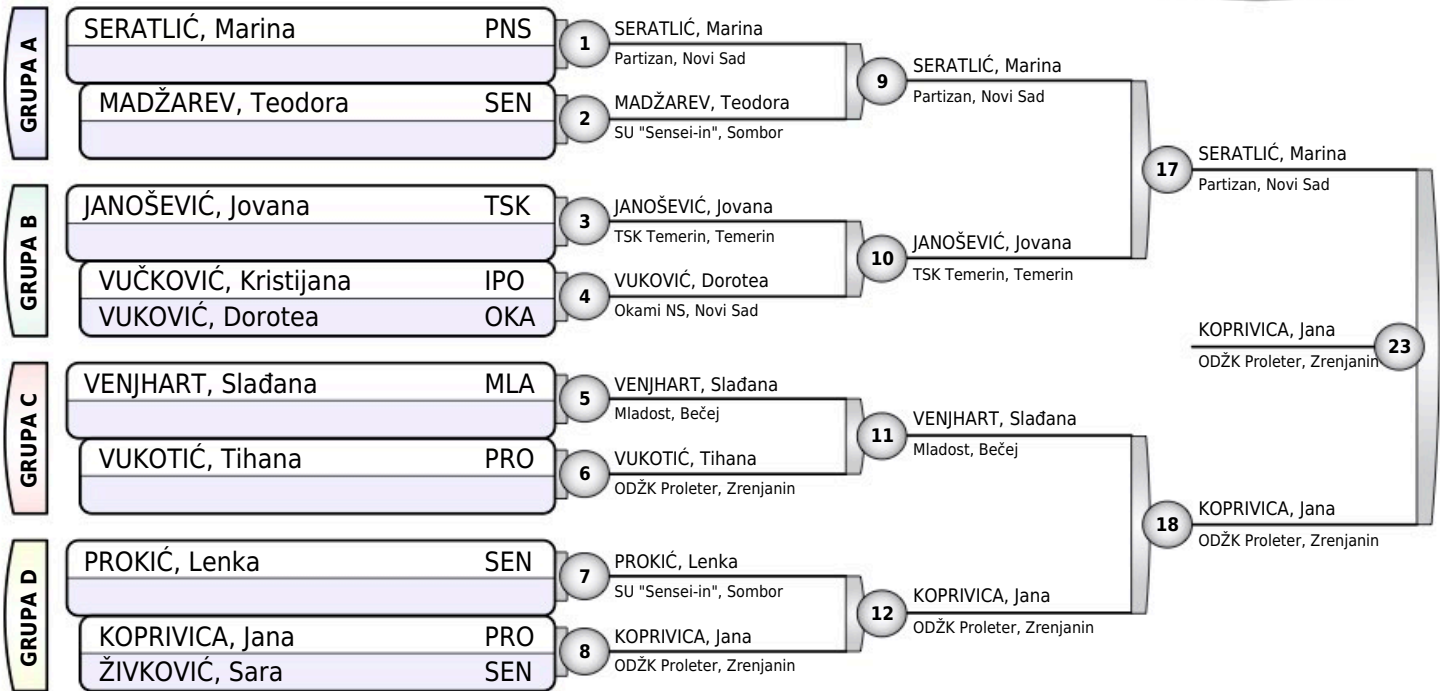

Rezultati

1. KOPRIVICA, Jana PRO
2. SERATLIĆ, Marina PNS
3. VENJHART, Slađana MLA
3. ŽIVKOVIĆ, Sara SEN
5. VUKOVIĆ, Dorotea OKA
5. JANOŠEVIĆ, Jovana TSK
7. MADŽAREV, Teodora SEN
7. VUKOTIĆ, Tihana PRO

