

# Regionalni Šampionat VOJVODINA - S.POLETARCI 2019

Stepanovićevo, 02.02.2019 - Stariji poletarci

**-22kg**

1 takmičar



## REZULTAT

1. BRKLJAC, Nemanja DZU

# Regionalni Šampionat VOJVODINA - S.POLETARCI 2019

Stepanovićevo, 02.02.2019 - Stariji poletarci



**-25kg**

4 takmičara

	TAKMIČAR	POBEDNIČKI BODOVI				POBEDA	BODOVA	MESTO
		1	2	3	4			
1	LEHNI, Kristian Jedinstvo, Kačarevo		100	100	100	3	300	1
2	AJDIĆ, Stefan Partizan, Novi Sad	0		100	100	2	200	2
3	AGOTIĆ, Marko Proleter MD, Zrenjanin	0	0		100	1	100	3
4	MILOJKOVIĆ, Miroslav Proleter MD, Zrenjanin	0	0	0		0	0	3

**Bodovi:** Ippon 100 / Wazaari 10 / Kazna 0.5

**Redosled borbi:** 1 - 2, 3 - 4 / 1 - 3, 2 - 4 / 1 - 4, 2 - 3

BORBE	TAKMIČAR	BODOVA	BODOVA	TAKMIČAR	VREME
1 - 2	LEHNI, Kristian Jedinstvo, Kačarevo	<b>100</b>	<b>0</b>	AJDIĆ, Stefan Partizan, Novi Sad	0:39
3 - 4	AGOTIĆ, Marko Proleter MD, Zrenjanin	<b>100</b>	<b>0</b>	MILOJKOVIĆ, Miroslav Proleter MD, Zrenjanin	0:29
1 - 3	LEHNI, Kristian Jedinstvo, Kačarevo	<b>100</b>	<b>0</b>	AGOTIĆ, Marko Proleter MD, Zrenjanin	0:34
2 - 4	AJDIĆ, Stefan Partizan, Novi Sad	<b>100</b>	<b>0</b>	MILOJKOVIĆ, Miroslav Proleter MD, Zrenjanin	0:37
1 - 4	LEHNI, Kristian Jedinstvo, Kačarevo	<b>100</b>	<b>0</b>	MILOJKOVIĆ, Miroslav Proleter MD, Zrenjanin	0:08
2 - 3	AJDIĆ, Stefan Partizan, Novi Sad	<b>100</b>	<b>0</b>	AGOTIĆ, Marko Proleter MD, Zrenjanin	0:20

## REZULTAT

1. LEHNI, Kristian	JED
2. AJDIĆ, Stefan	PNS
3. AGOTIĆ, Marko	PRO
3. MILOJKOVIĆ, Miroslav	PRO

# Regionalni Šampionat VOJVODINA - S.POLETARCI 2019

Stepanovićevo, 02.02.2019 - Stariji poletarci



**-28kg**

17 takmičara

GRUPA A

1	SABADOŠ, Andrija	OKA	17
9	POPOVIĆ, Aleksa	S18	25
5	BOŠKOVIĆ, Gavrilo	DIN	21
13	MANDRAŠ, Matija	NJK	29

1	SABADOŠ, Andrija	Okami NS, Novi Sad	17
2	POPOVIĆ, Aleksa	Sambo 18, Novi Sad	17
3	BOŠKOVIĆ, Gavrilo	Dinamo, Pančevo	18
4	MANDRAŠ, Matija	Novosadski džudo klub, Novi Sad	18

25	BOŠKOVIĆ, Gavrilo	Dinamo, Pančevo
26	ANĐELOVIĆ, Ilija	Jedinstvo, Kačarevo
37	ANĐELOVIĆ, Ilija	Jedinstvo, Kačarevo

GRUPA B

4	DOLINGA, Nikola	DIN	20
12	MITROVIĆ, Dušan	PRO	28
8	ANĐELOVIĆ, Ilija	JED	24
16	KALAPATI, Dominik	TSK	32

5	DOLINGA, Nikola	Dinamo, Pančevo	19
6	KOKAI, Uroš	Lokomotiva, Vršac	19
7	ANĐELOVIĆ, Ilija	Jedinstvo, Kačarevo	20
8	KALAPATI, Dominik	TSK Temerin, Temerin	20

26	ANĐELOVIĆ, Ilija	Jedinstvo, Kačarevo
43	ANĐELOVIĆ, Ilija	Jedinstvo, Kačarevo

GRUPA C

2	VUKOVIĆ, Mihajlo	PAN	18
10	PRAPORSKI, Nikola	PRO	26
6	LEČEI, Marko	DIN	22
14	NOVAKOVIĆ, Uros	OKA	30

9	VUKOVIĆ, Mihajlo	Pančevo, Pančevo	21
10	PRAPORSKI, Nikola	Proleter MD, Zrenjanin	21
11	LEČEI, Marko	Dinamo, Pančevo	22
12	NOVAKOVIĆ, Uros	Okami NS, Novi Sad	22

27	NOVAKOVIĆ, Uros	Okami NS, Novi Sad
38	BAJUS, Daniel	Partizan KOT Kanjiza, Kanjiza

GRUPA D

3	STOJANOVSKI, Maksim	JED	19
11	BILIĆ, Nikola	KNJ	27
7	BAJUS, Daniel	PKO	23
15	STANKOV, Miloš	LOK	31

13	STOJANOVSKI, Maksim	Jedinstvo, Kačarevo	23
14	BILIĆ, Nikola	Kanjiza, Kanjiza	23
15	BAJUS, Daniel	Partizan KOT Kanjiza, Kanjiza	24
16	STANKOV, Miloš	Lokomotiva, Vršac	24

28	BAJUS, Daniel	Partizan KOT Kanjiza, Kanjiza
42	STOJANOVSKI, Maksim	Jedinstvo, Kačarevo

REZULTAT	
1.	ANĐELOVIĆ, Ilija JED
2.	BAJUS, Daniel PKO
3.	DOLINGA, Nikola DIN
3.	STOJANOVSKI, Maksim JED
5.	NOVAKOVIĆ, Uros OKA
6.	BOŠKOVIĆ, Gavrilo DIN
7.	MANDRAŠ, Matija NJK
7.	VUKOVIĆ, Mihajlo PAN

REPASAŽ

[A1]		[29] MANDRAŠ, Matija	[33] MANDRAŠ, Matija	
[A2]	MANDRAŠ, Matija	NJK	[30] KALAPATI, Dominik	[39] DOLINGA, Nikola
[B1]		[31] LEČEI, Marko	[35] VUKOVIĆ, Mihajlo	
[B2]	KALAPATI, Dominik	TSK	[32] STANKOV, Miloš	[40] STOJANOVSKI, Maksim
[B3]		[32] STANKOV, Miloš	[36] STOJANOVSKI, Maksim	[42] STOJANOVSKI, Maksim
[C1]		[33] MANDRAŠ, Matija	[37] BOŠKOVIĆ, Gavrilo	
[C2]	LEČEI, Marko	DIN		
[D1]		[34] DOLINGA, Nikola		
[D2]	STANKOV, Miloš	LOK		
[D3]		[36] STOJANOVSKI, Maksim		

# Regionalni Šampionat VOJVODINA - S.POLETARCI 2019

Stepanovićevo, 02.02.2019 - Stariji poletarci



**-31kg**

21 takmičar

GRUPA A

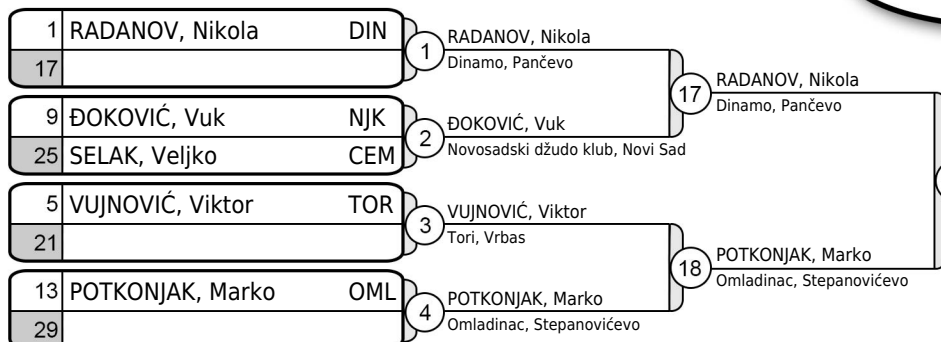

25 RADANOV, Nikola  
Dinamo, Pančevo  
**GRUPA A - Pobjednik**

GRUPA B

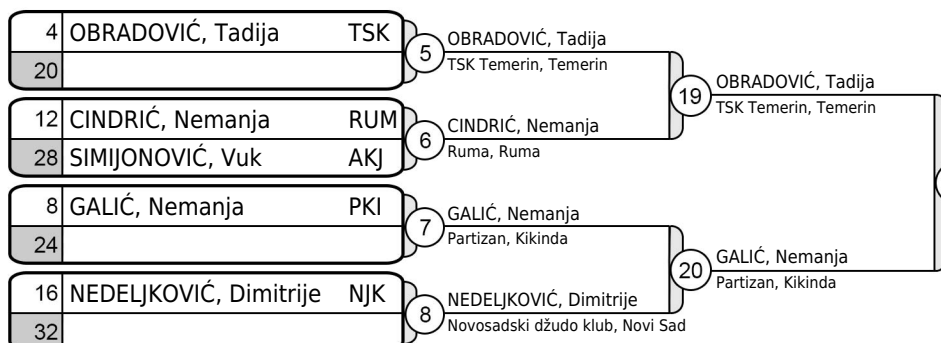

26 GALIĆ, Nemanja  
Partizan, Kikinda  
**GRUPA B - Pobjednik**

GRUPA C

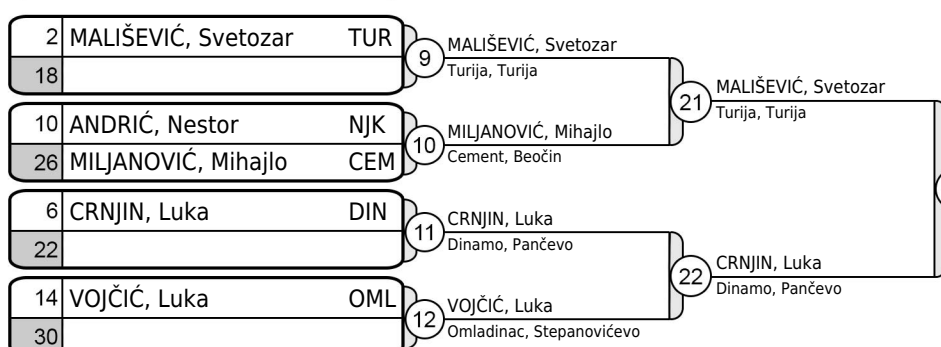

27 MALIŠEVIĆ, Svetozar  
Turija, Turija  
**GRUPA C - Pobjednik**

GRUPA D

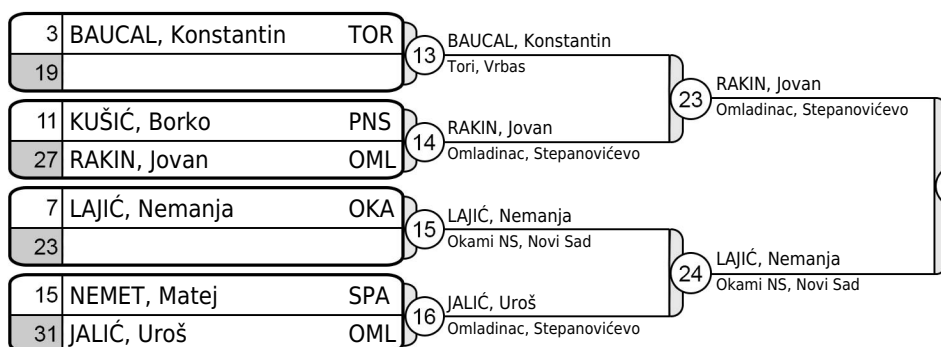

28 RAKIN, Jovan  
Omladinac, Stepanovićevo  
**GRUPA D - Pobjednik**

MALIŠEVIĆ, Svetozar

1.

## REZULTAT

1.	MALIŠEVIĆ, Svetozar	TUR
2.	RADANOV, Nikola	DIN
3.	RAKIN, Jovan	OML
3.	GALIĆ, Nemanja	PKI
5.	OBRADOVIĆ, Tadija	TSK
7.	LAJIĆ, Nemanja	OKA
7.	POTKONJAK, Marko	OML
7.	MILJANOVIĆ, Mihajlo	CEM

REPASAŽ

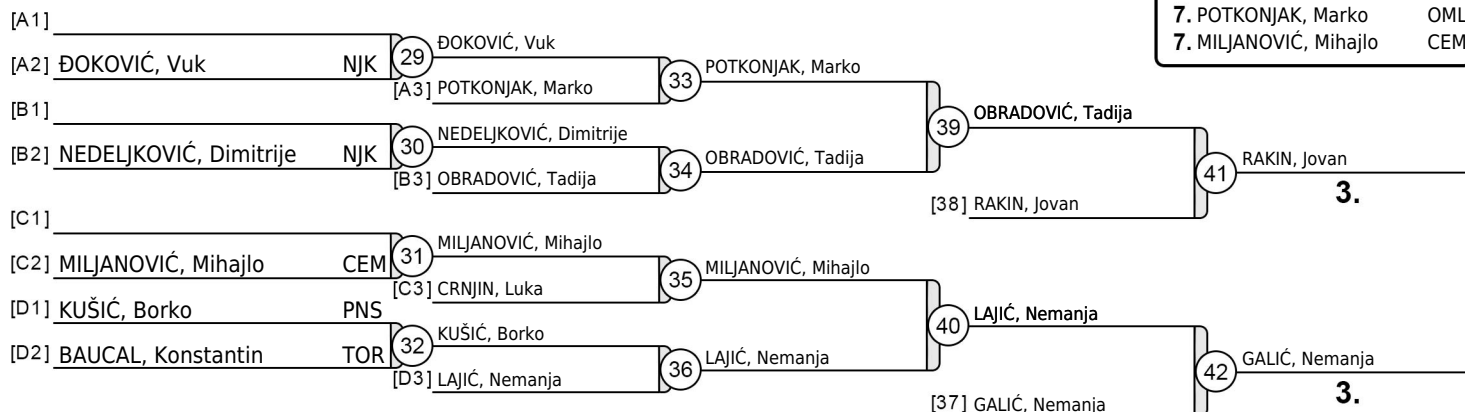

# Regionalni Šampionat VOJVODINA - S.POLETARCI 2019

Stepanovićevo, 02.02.2019 - Stariji poletarci



**-34kg**

9 takmičara

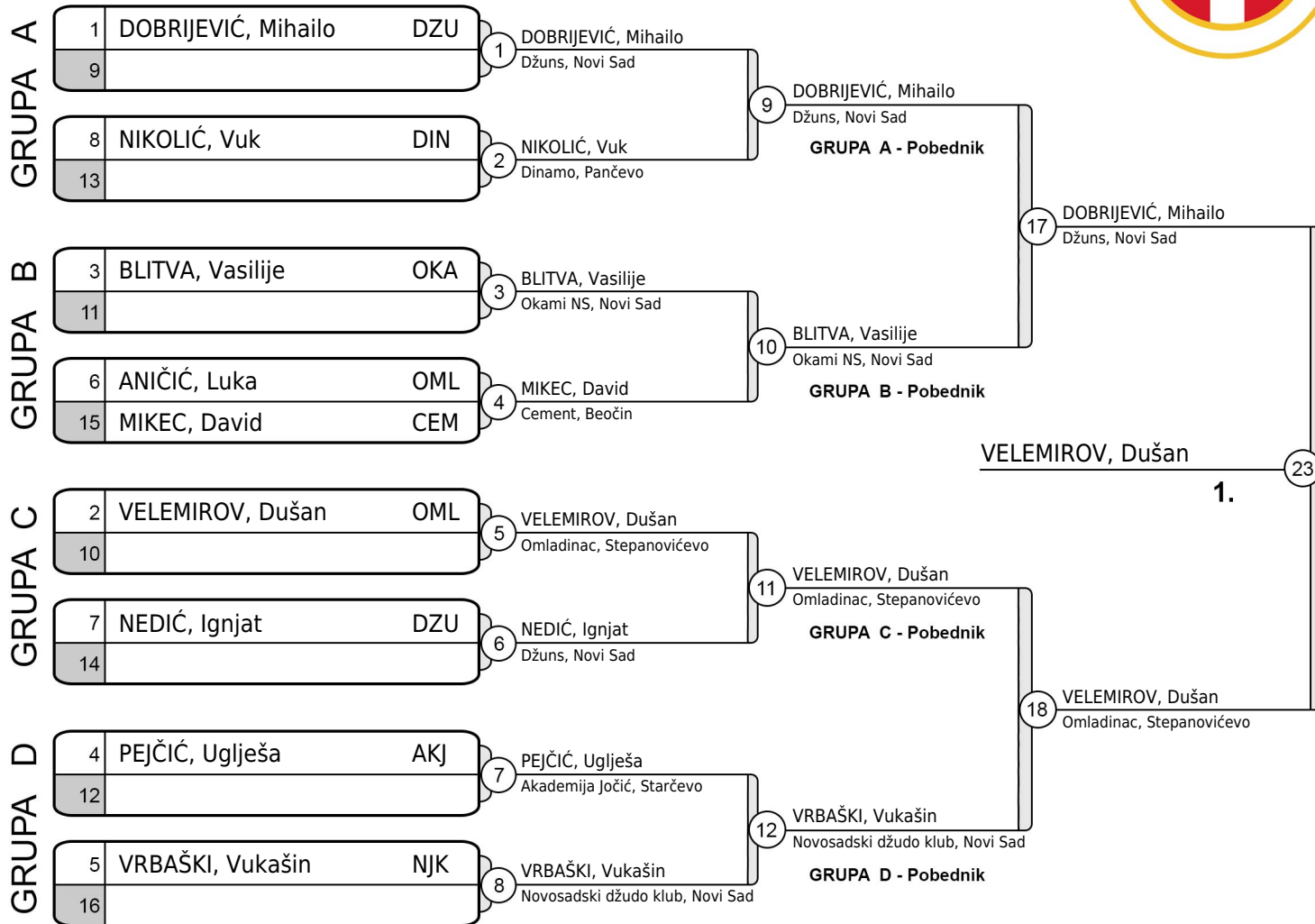

## REZULTAT

1. VELEMIROV, Dušan OML
2. DOBRIJEVIĆ, Mihailo DZU
3. VRBAŠKI, Vukašin NJK
3. BLITVA, Vasilije OKA
5. NIKOLIĆ, Vuk DIN
5. PEJČIĆ, Uglješa AKJ
7. MIKEC, David CEM
7. NEDIĆ, Ignjat DZU

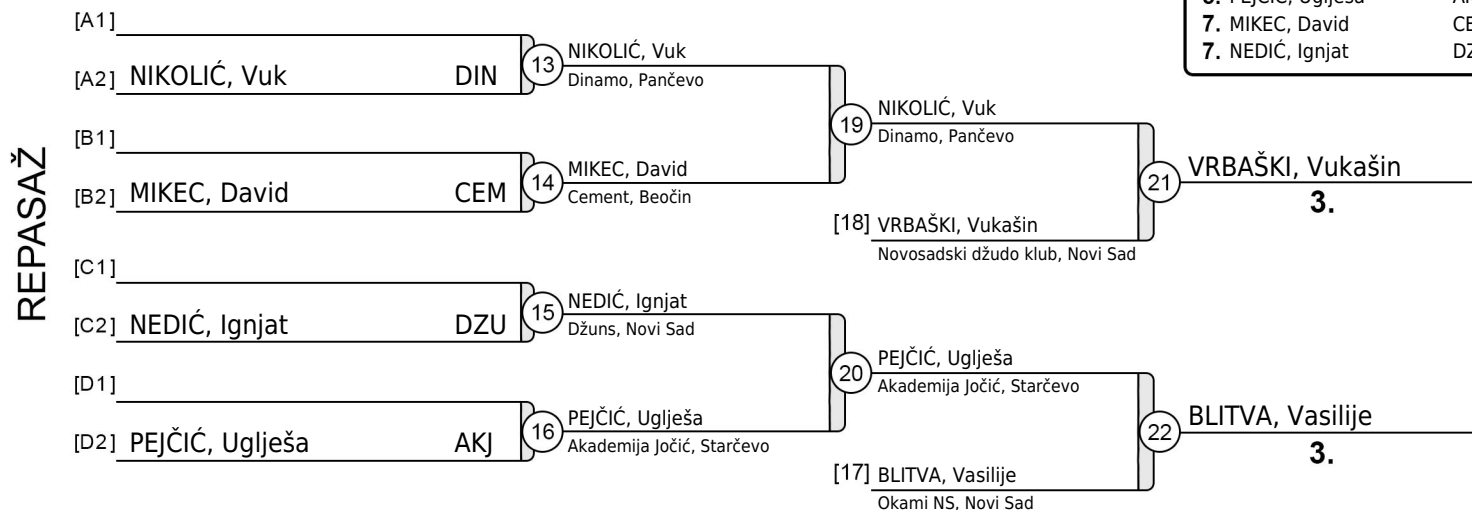

# Regionalni Šampionat VOJVODINA - S.POLETARCI 2019

Stepanovićevo, 02.02.2019 - Stariji poletarci



**-38kg**

9 takmičara

GRUPA A

1 OŽEGOVIĆ, Ognjen LOK  
9

1 OŽEGOVIĆ, Ognjen  
Lokomotiva, Vršac

2 KECOJEVIĆ, Pavle  
Okami NS, Novi Sad

9 OŽEGOVIĆ, Ognjen  
Lokomotiva, Vršac  
**GRUPA A - Pobjednik**

GRUPA B

3 BASTIĆ, Dejan SPA  
11

3 BASTIĆ, Dejan  
Spartak, Subotica

4 ANIČIĆ, Uros  
Omladinac, Stepanovićevo

10 ANIČIĆ, Uros  
Omladinac, Stepanovićevo  
**GRUPA B - Pobjednik**

GRUPA C

2 MILOŠEVIĆ, Ilija DZU  
10

5 MILOŠEVIĆ, Ilija  
Džuns, Novi Sad

6 ŠUŠAK, Uroš  
Okami NS, Novi Sad

11 MILOŠEVIĆ, Ilija  
Džuns, Novi Sad  
**GRUPA C - Pobjednik**

GRUPA D

4 RADANOV, Mihajlo OKA  
12

7 RADANOV, Mihajlo  
Okami NS, Novi Sad

8 CVETKOVIĆ, Željko  
Akademija Jočić, Starčevo

12 RADANOV, Mihajlo  
Okami NS, Novi Sad  
**GRUPA D - Pobjednik**

MILOŠEVIĆ, Ilija

1.



## REZULTAT

- |    |                   |     |
|----|-------------------|-----|
| 1. | MILOŠEVIĆ, Ilija  | DZU |
| 2. | ANIČIĆ, Uros      | OML |
| 3. | MILOVIĆ, Mihajlo  | CEM |
| 3. | ŠUŠAK, Uroš       | OKA |
| 5. | RADANOV, Mihajlo  | OKA |
| 5. | OŽEGOVIĆ, Ognjen  | LOK |
| 7. | KECOJEVIĆ, Pavle  | OKA |
| 7. | CVETKOVIĆ, Željko | AKJ |

REPASAŽ

[A1] \_\_\_\_\_

[A2] KECOJEVIĆ, Pavle OKA  
13

13 KECOJEVIĆ, Pavle  
Okami NS, Novi Sad

19 MILOVIĆ, Mihajlo  
Cement, Beočin

[B1] MILOVIĆ, Mihajlo CEM

[B2] BASTIĆ, Dejan SPA  
14

14 MILOVIĆ, Mihajlo  
Cement, Beočin

[18] RADANOV, Mihajlo  
Okami NS, Novi Sad

21 MILOVIĆ, Mihajlo  
**3.**

[C1] \_\_\_\_\_

[C2] ŠUŠAK, Uroš OKA  
15

15 ŠUŠAK, Uroš  
Okami NS, Novi Sad

20 ŠUŠAK, Uroš  
Okami NS, Novi Sad

[D1] \_\_\_\_\_

[D2] CVETKOVIĆ, Željko AKJ  
16

16 CVETKOVIĆ, Željko  
Akademija Jočić, Starčevo

[17] OŽEGOVIĆ, Ognjen  
Lokomotiva, Vršac

22 ŠUŠAK, Uroš  
**3.**

# Regionalni Šampionat VOJVODINA - S. POLETARCI 2019

Stepanovićevo, 02.02.2019 - Stariji poletarci



**-42kg**

9 takmičara

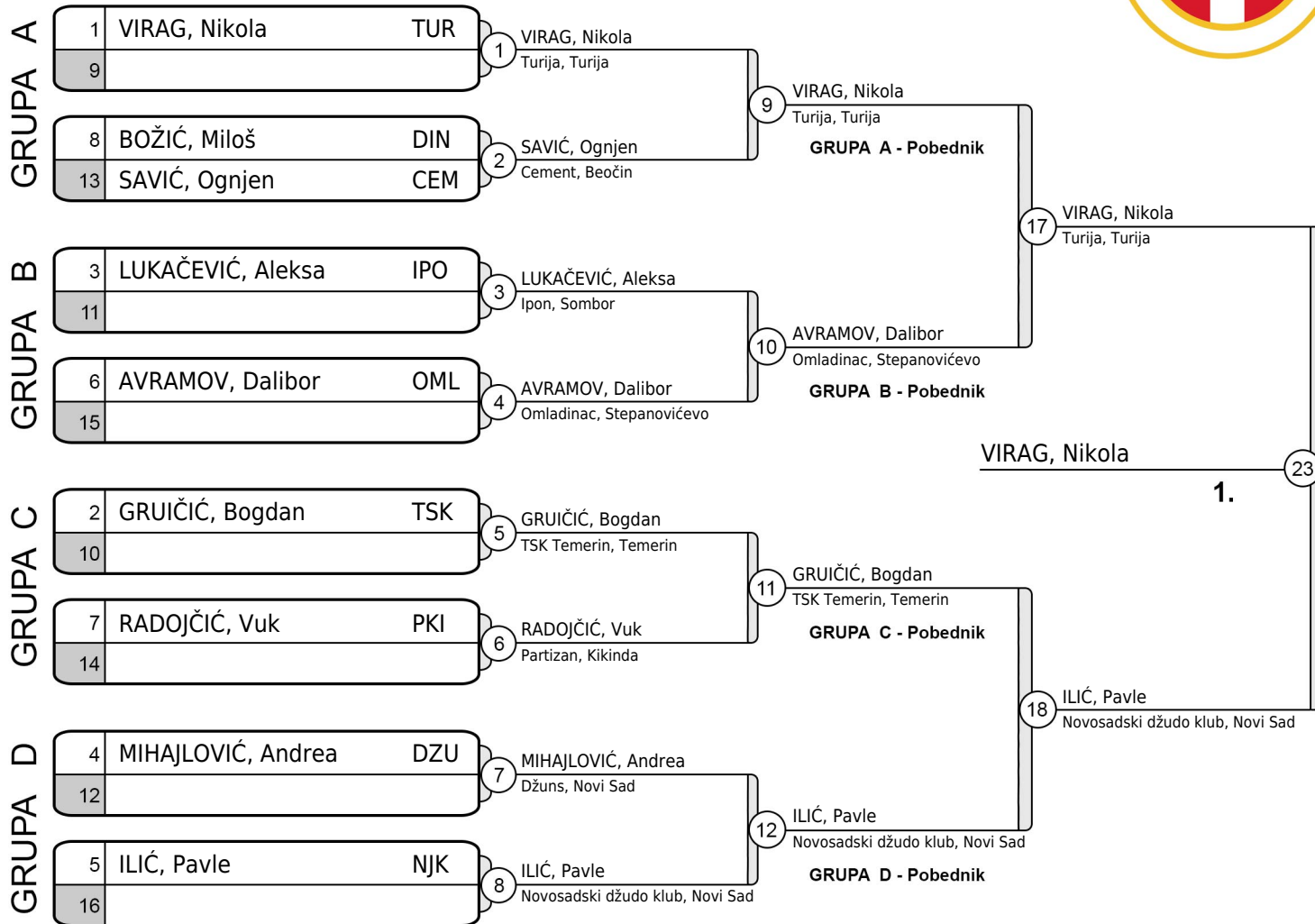

## REZULTAT

1.	VIRAG, Nikola	TUR
2.	ILIĆ, Pavle	NJK
3.	SAVIĆ, Ognjen	CEM
3.	AVRAMOV, Dalibor	OML
5.	GRUIČIĆ, Bogdan	TSK
5.	MIHAJLOVIĆ, Andrea	DZU
7.	LUKAČEVIĆ, Aleksa	IPO
7.	RADOJČIĆ, Vuk	PKI

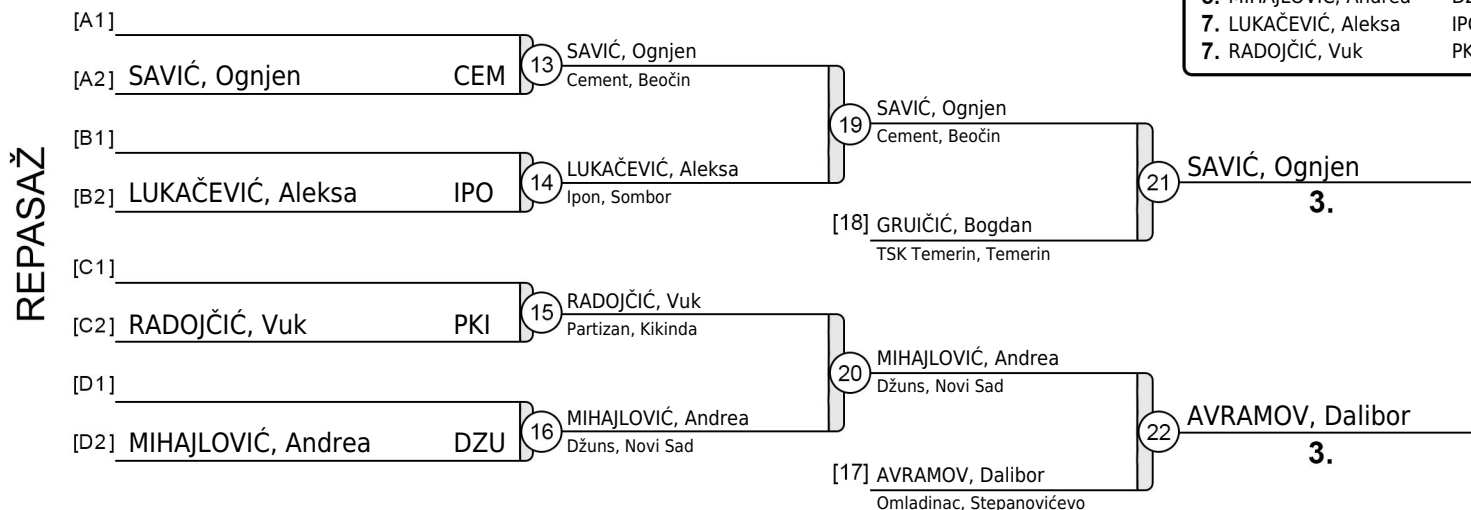

# Regionalni Šampionat VOJVODINA - S.POLETARCI 2019

Stepanovićevo, 02.02.2019 - Stariji poletarci



**-46kg**

10 takmičara

GRUPA A

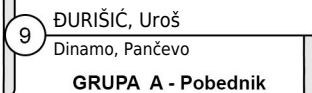
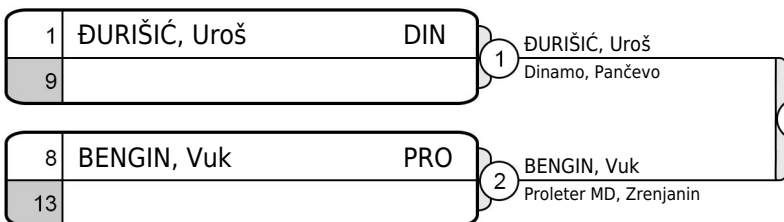

GRUPA B

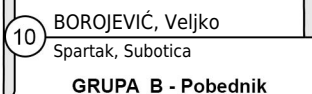
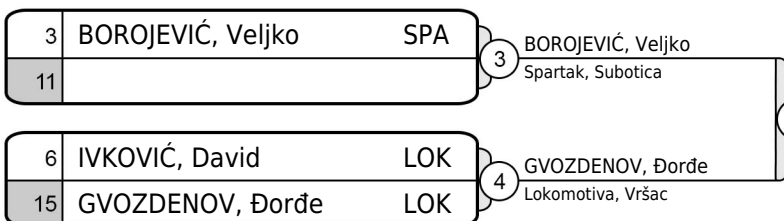

GRUPA C

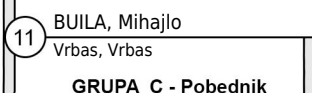
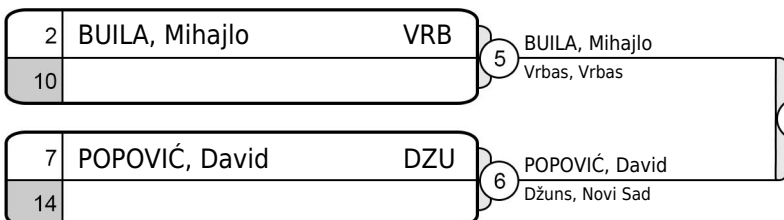

GRUPA D

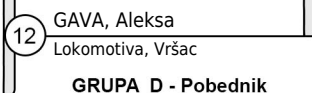
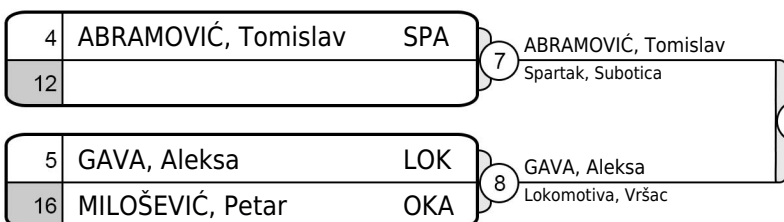

ĐURIŠIĆ, Uroš **1.**

18 GAVA, Aleksa  
Lokomotiva, Vršac

17 ĐURIŠIĆ, Uroš  
Dinamo, Pančevo

9

1

23

## REZULTAT

1.	ĐURIŠIĆ, Uroš	DIN
2.	GAVA, Aleksa	LOK
3.	BENGIN, Vuk	PRO
3.	BOROJEVIĆ, Veljko	SPA
5.	BUILA, Mihajlo	VRB
5.	MILOŠEVIĆ, Petar	OKA
7.	GVOZDENOV, Đorđe	LOK
7.	POPOVIĆ, David	DZU

REPASAŽ

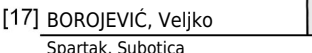
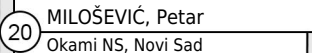
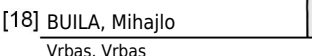
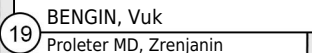
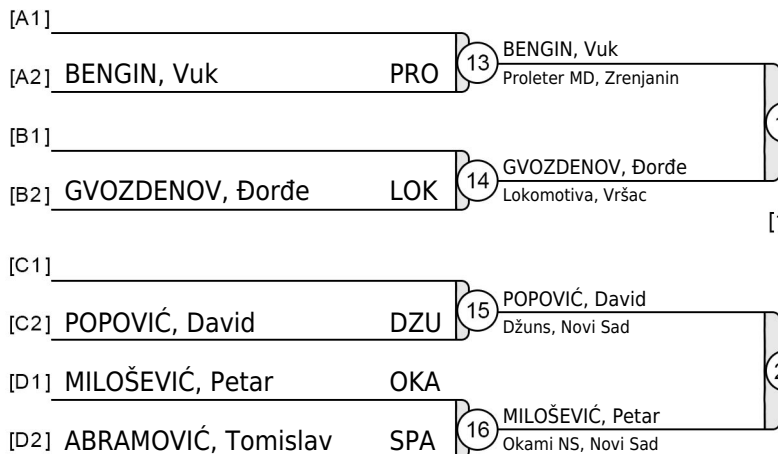

21 BENGIN, Vuk **3.**

22 BOROJEVIĆ, Veljko **3.**



# Regionalni Šampionat VOJVODINA - S.POLETARCI 2019

Stepanovićevo, 02.02.2019 - Stariji poletarci



**-50kg**

5 takmičara

	TAKMIČAR	POBEDNIČKI BODOVI					POBEDA	BODOVA	MESTO
		1	2	3	4	5			
1	MILOŠEVIĆ, Danilo Okami NS, Novi Sad		100	0	100	0	2	200	3
2	MARTINOVIĆ, Dušan Tori, Vrbas	0		0	100	0	1	100	3
3	VUKOBRAT, Ognjen Proleter MD, Zrenjanin	10	100		100	100	4	310	1
4	MAJSTOROVIĆ, Stefan Novosadski džudo klub, Novi Sad	0	0	0		0	0	0	5
5	PANIĆ, Veljko Omladinac, Stepanovićevo	100	100	0	100		3	300	2

**Bodovi:** Ippon 100 / Wazaari 10 / Kazna 0.5

**Redosled borbi:** 1 - 2, 3 - 4 / 1 - 5, 2 - 3 / 4 - 5, 1 - 3 / 2 - 4, 3 - 5 / 1 - 4, 2 - 5

BORBE	TAKMIČAR	BODOVA	BODOVA	TAKMIČAR	VREME
1 - 2	MILOŠEVIĆ, Danilo Okami NS, Novi Sad	<b>100</b>	<b>0</b>	MARTINOVIĆ, Dušan Tori, Vrbas	0:30
3 - 4	VUKOBRAT, Ognjen Proleter MD, Zrenjanin	<b>100</b>	<b>0</b>	MAJSTOROVIĆ, Stefan Novosadski džudo klub, Novi Sad	0:14
1 - 5	MILOŠEVIĆ, Danilo Okami NS, Novi Sad	<b>0</b>	<b>100</b>	PANIĆ, Veljko Omladinac, Stepanovićevo	1:05
2 - 3	MARTINOVIĆ, Dušan Tori, Vrbas	<b>0</b>	<b>100</b>	VUKOBRAT, Ognjen Proleter MD, Zrenjanin	0:28
4 - 5	MAJSTOROVIĆ, Stefan Novosadski džudo klub, Novi Sad	<b>0</b>	<b>100</b>	PANIĆ, Veljko Omladinac, Stepanovićevo	0:00
1 - 3	MILOŠEVIĆ, Danilo Okami NS, Novi Sad	<b>0</b>	<b>10</b>	VUKOBRAT, Ognjen Proleter MD, Zrenjanin	1:59
2 - 4	MARTINOVIĆ, Dušan Tori, Vrbas	<b>100</b>	<b>0</b>	MAJSTOROVIĆ, Stefan Novosadski džudo klub, Novi Sad	0:00
3 - 5	VUKOBRAT, Ognjen Proleter MD, Zrenjanin	<b>100</b>	<b>0</b>	PANIĆ, Veljko Omladinac, Stepanovićevo	0:17
1 - 4	MILOŠEVIĆ, Danilo Okami NS, Novi Sad	<b>100</b>	<b>0</b>	MAJSTOROVIĆ, Stefan Novosadski džudo klub, Novi Sad	0:15
2 - 5	MARTINOVIĆ, Dušan Tori, Vrbas	<b>0</b>	<b>100</b>	PANIĆ, Veljko Omladinac, Stepanovićevo	0:12

## REZULTAT

1. VUKOBRAT, Ognjen PRO
2. PANIĆ, Veljko OML
3. MILOŠEVIĆ, Danilo OKA
3. MARTINOVIĆ, Dušan TOR
5. MAJSTOROVIĆ, Stefan NJK

# Regionalni Šampionat VOJVODINA - S.POLETARCI 2019

Stepanovićevo, 02.02.2019 - Stariji poletarci

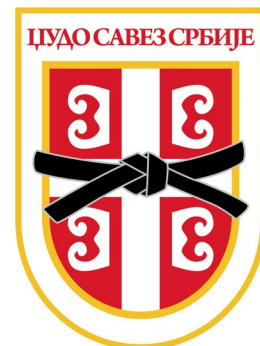

**+50kg**

6 takmičara

BORBE	TAKMIČAR	BODOVA	BODOVA	TAKMIČAR	VREME
1 - 2	ILIĆ, Mateja Akademija Jočić, Starčevo	100	0	JADŽIĆ, David Borac, Novi Sad	1:01
1 - 3	ILIĆ, Mateja Akademija Jočić, Starčevo	100	0	MALEŠEV, Lazar Proleter MD, Zrenjanin	0:43
2 - 3	JADŽIĆ, David Borac, Novi Sad	100	0	MALEŠEV, Lazar Proleter MD, Zrenjanin	1:30

[A1] ILIĆ, Mateja	AKJ	7	ILIĆ, Mateja Akademija Jočić, Starčevo
[B2] DESPOT, Stefan	IPO		
[B1] BALOG, Kristian	PAN	8	BALOG, Kristian Pančevo, Pančevo
[A2] JADŽIĆ, David	BNS		
		9	ILIĆ, Mateja Akademija Jočić, Starčevo

BORBE	TAKMIČAR	BODOVA	BODOVA	TAKMIČAR	VREME
4 - 5	JAĆIMOVIĆ, Petar Borac, Novi Sad	0	100	BALOG, Kristian Pančevo, Pančevo	0:18
4 - 6	JAĆIMOVIĆ, Petar Borac, Novi Sad	0	100	DESPOT, Stefan Ipon, Sombor	1:43
5 - 6	BALOG, Kristian Pančevo, Pančevo	100	0	DESPOT, Stefan Ipon, Sombor	0:22

**BODOVI:** Ippon 100 / Wazaari 10 / Kazna 0.5

**Redosled borbi:** 1 - 2 / 4 - 5 / 1 - 3 / 4 - 6 / 2 - 3 / 5 - 6

## REZULTAT

1.	ILIĆ, Mateja	AKJ
2.	BALOG, Kristian	PAN
3.	DESPOT, Stefan	IPO
3.	JADŽIĆ, David	BNS
5.	MALEŠEV, Lazar	PRO
5.	JAĆIMOVIĆ, Petar	BNS

# Regionalni Šampionat VOJVODINA - S.POLETARCI 2019

Stepanovićevo, 02.02.2019 - Starije poletarke



**-22kg**  
0 takmičarki

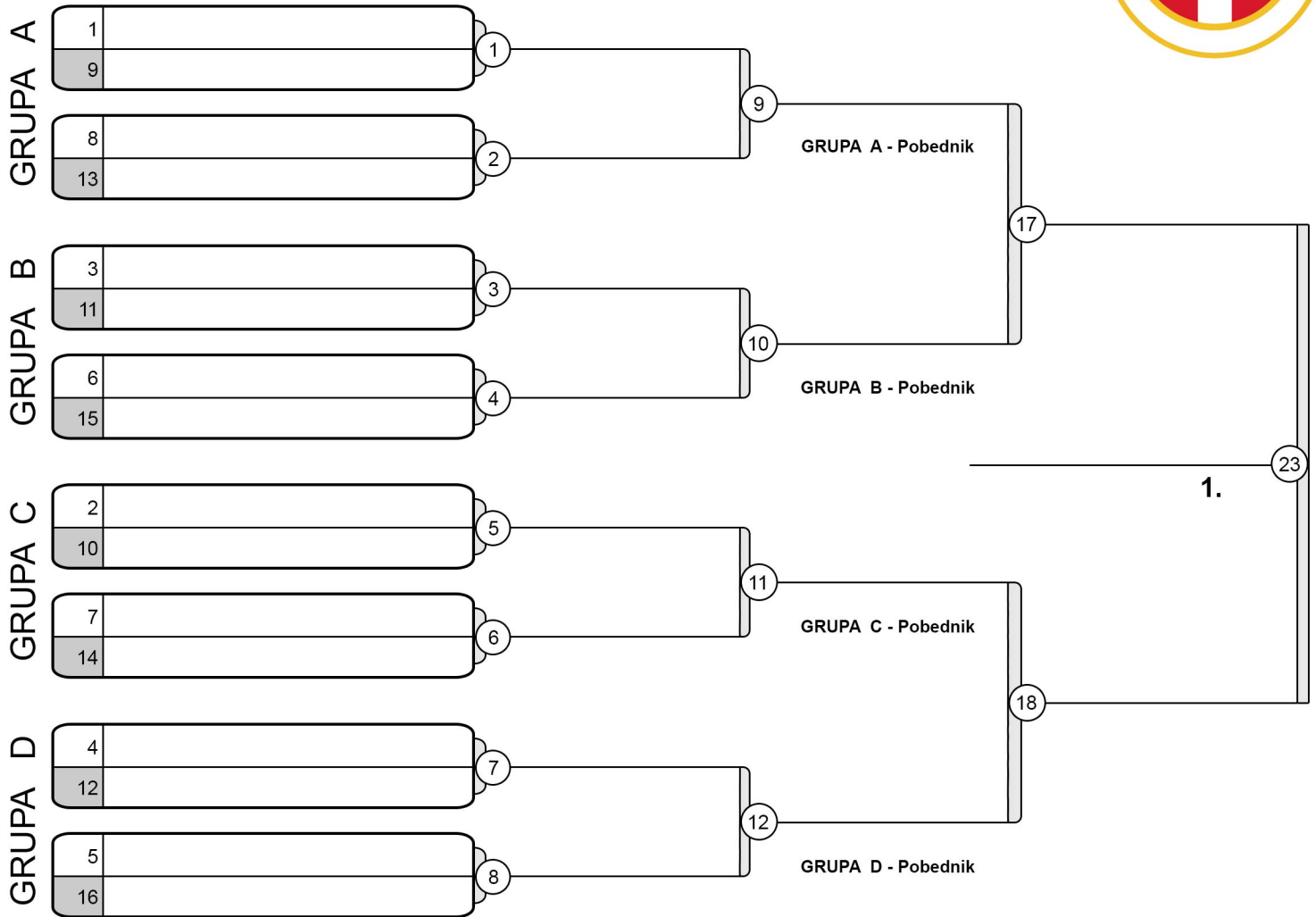

**REZULTAT**

- 1.
- 2.
- 3.
- 3.
- 5.
- 7.
- 7.

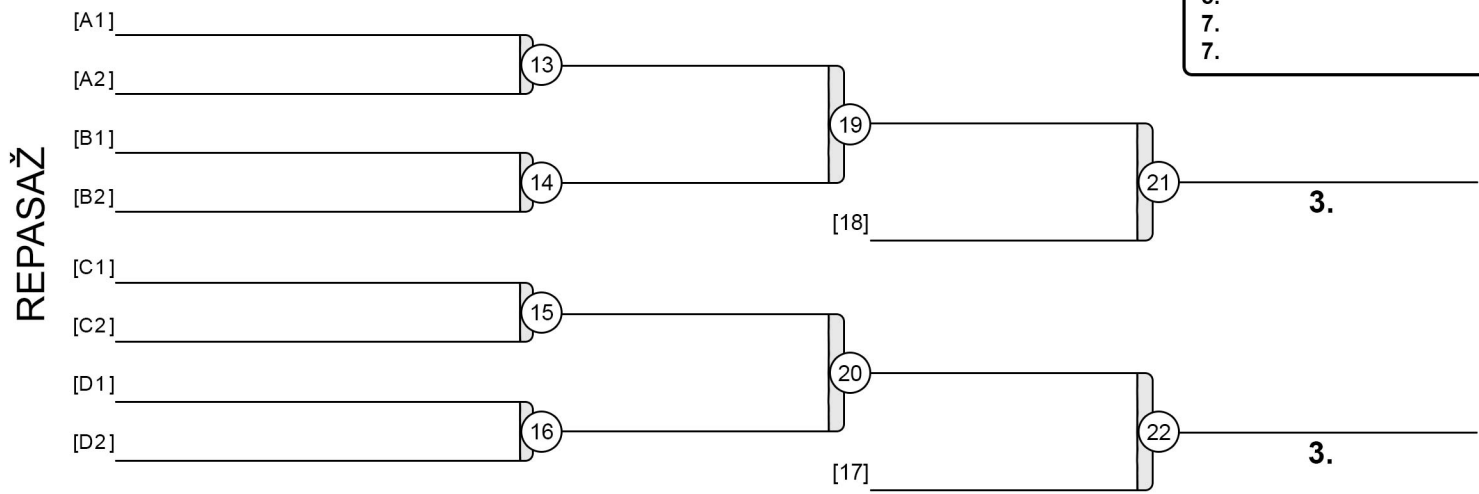

# Regionalni Šampionat VOJVODINA - S.POLETARCI 2019

Stepanovićevo, 02.02.2019 - Starije poletarke



**-25kg**

4 takmičarki

	TAKMIČAR	POBEDNIČKI BODOVI				POBEDA	BODOVA	MESTO
		1	2	3	4			
1	KUPREŠAK, Lana Novosadski džudo klub, Novi Sad		10	100	100	3	210	1
2	ARVAI, Andrea Omladinac, Stepanovićevo	0		0	100	1	100	3
3	JOVANOVIĆ, Božana Turija, Turija	0	100		100	2	200	2
4	MIRIĆ, Ivana Cement, Beočin	0	0	0		0	0	3

**Bodovi:** Ippon 100 / Wazaari 10 / Kazna 0.5

**Redosled borbi:** 1 - 2, 3 - 4 / 1 - 3, 2 - 4 / 1 - 4, 2 - 3

BORBE	TAKMIČAR	BODOVA	BODOVA	TAKMIČAR	VREME
1 - 2	KUPREŠAK, Lana Novosadski džudo klub, Novi Sad	<b>10</b>	<b>0</b>	ARVAI, Andrea Omladinac, Stepanovićevo	2:00
3 - 4	JOVANOVIĆ, Božana Turija, Turija	<b>100</b>	<b>0</b>	MIRIĆ, Ivana Cement, Beočin	1:24
1 - 3	KUPREŠAK, Lana Novosadski džudo klub, Novi Sad	<b>100</b>	<b>0</b>	JOVANOVIĆ, Božana Turija, Turija	0:38
2 - 4	ARVAI, Andrea Omladinac, Stepanovićevo	<b>100</b>	<b>0</b>	MIRIĆ, Ivana Cement, Beočin	1:17
1 - 4	KUPREŠAK, Lana Novosadski džudo klub, Novi Sad	<b>100</b>	<b>0</b>	MIRIĆ, Ivana Cement, Beočin	0:41
2 - 3	ARVAI, Andrea Omladinac, Stepanovićevo	<b>0</b>	<b>100</b>	JOVANOVIĆ, Božana Turija, Turija	1:52

## REZULTAT

1. KUPREŠAK, Lana	NJK
2. JOVANOVIĆ, Božana	TUR
3. ARVAI, Andrea	OML
3. MIRIĆ, Ivana	CEM

# Regionalni Šampionat VOJVODINA - S.POLETARCI 2019

Stepanovićevo, 02.02.2019 - Starije poletarke



**-28kg**

8 takmičarki

GRUPA A

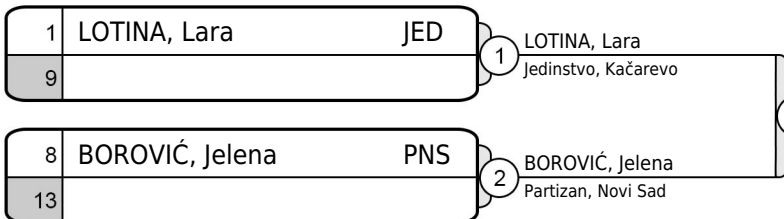

GRUPA B

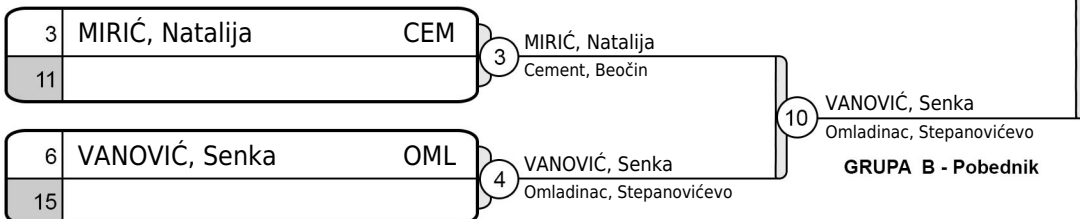

GRUPA C

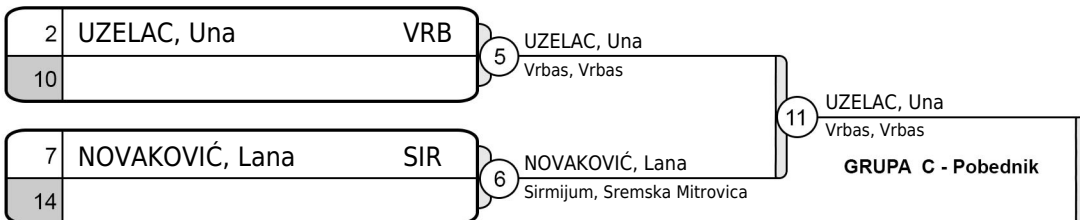

GRUPA D

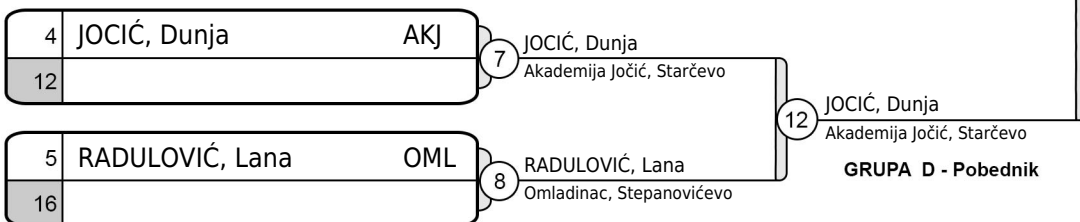

17 VANOVIĆ, Senka  
Omladinac, Stepanovićevo

23 UZELAC, Una  
**1.**

## REZULTAT

1. UZELAC, Una	VRB
2. VANOVIĆ, Senka	OML
3. JOCIĆ, Dunja	AKJ
3. RADULOVIĆ, Lana	OML
5. MIRIĆ, Natalija	CEM
5. BOROVIĆ, Jelena	PNS
7. LOTINA, Lara	JED
7. NOVAKOVIĆ, Lana	SIR

REPASAŽ

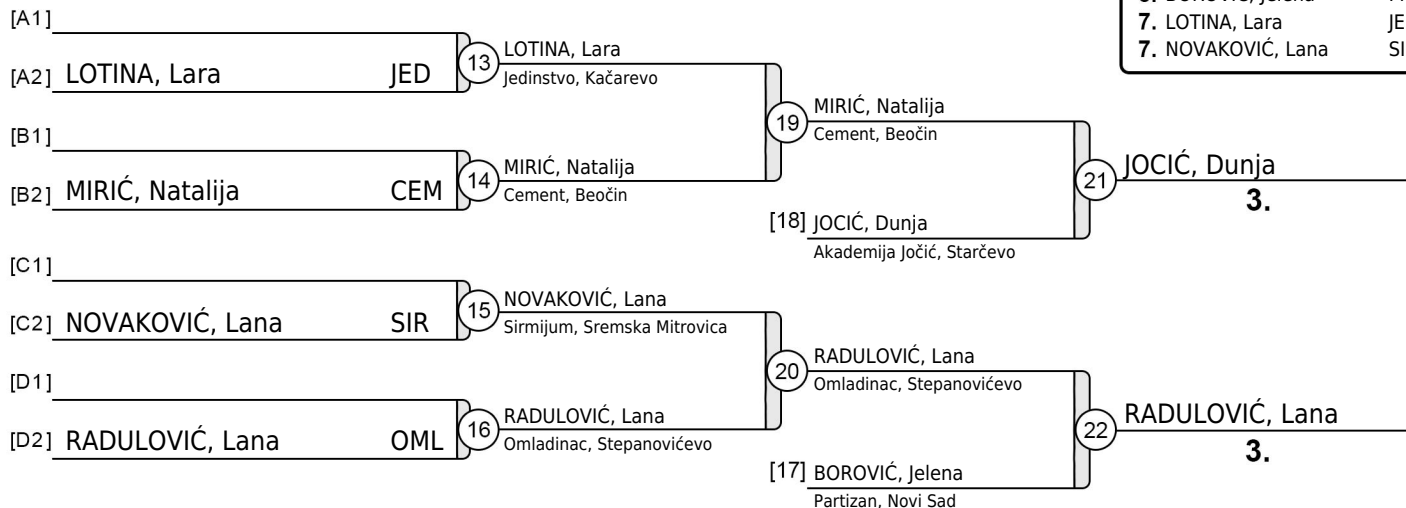

# Regionalni Šampionat VOJVODINA - S.POLETARCI 2019

Stepanovićevo, 02.02.2019 - Starije poletarke



**-31kg**

8 takmičarki

GRUPA A

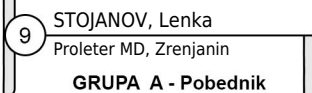
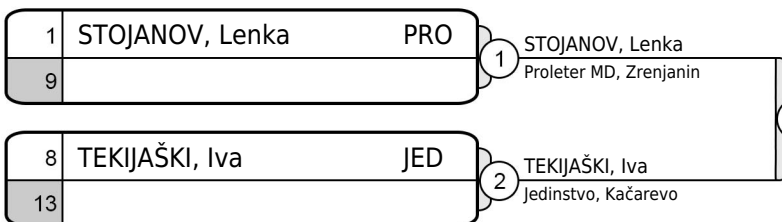

GRUPA B

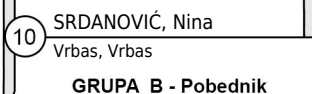
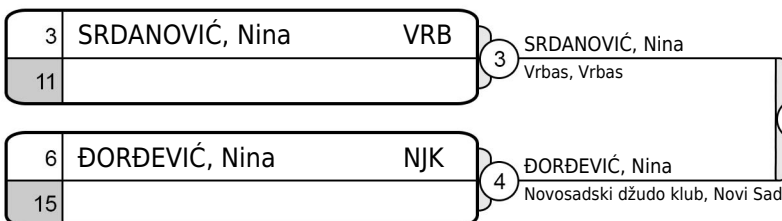

GRUPA C

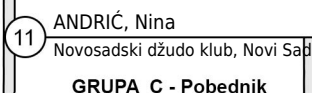
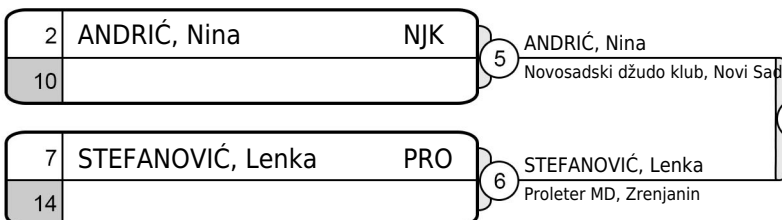

GRUPA D

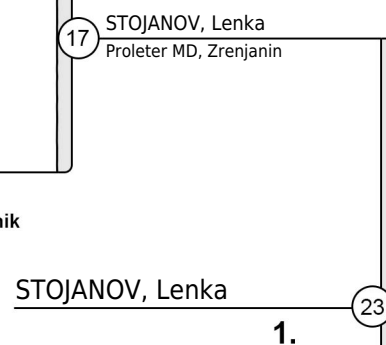
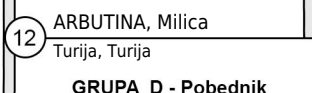
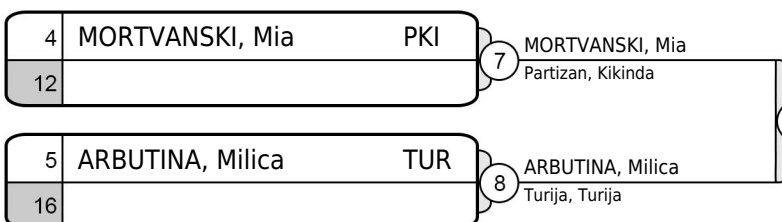

## REZULTAT

- |    |                   |     |
|----|-------------------|-----|
| 1. | STOJANOV, Lenka   | PRO |
| 2. | ANDRIĆ, Nina      | NJK |
| 3. | ĐORĐEVIĆ, Nina    | NJK |
| 4. | MORTVANSKI, Mia   | PKI |
| 5. | ARBUTINA, Milica  | TUR |
| 6. | SRDANOVIĆ, Nina   | VRB |
| 7. | TEKIJASKI, Iva    | JED |
| 8. | STEFANOVIĆ, Lenka | PRO |

REPASAŽ

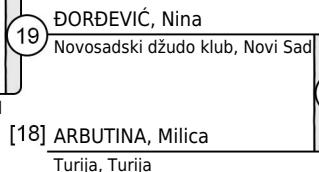

# Regionalni Šampionat VOJVODINA - S.POLETARCI 2019

Stepanovićevo, 02.02.2019 - Starije poletarke



## -34kg

5 takmičarki

	TAKMIČAR	POBEDNIČKI BODOVI					POBEDA	BODOVA	MESTO
		1	2	3	4	5			
1	BANIKA, Marija Jugović, Kać		100	100	100	100	4	400	1
2	MALEŠ, Mia TSK Temerin, Temerin	0		100	10	100	3	210	2
3	FORGO, Andrea Spartak, Subotica	0	0		0	100	1	100	3
4	RADOVIĆ, Tatjana Sirig, Sirig	0	0	100		100	2	200	3
5	JOVANOVIĆ, Jovana Turija, Turija	0	0	0	0		0	0	5

**Bodovi:** Ippon 100 / Wazaari 10 / Kazna 0.5

**Redosled borbi:** 1 - 2, 3 - 4 / 1 - 5, 2 - 3 / 4 - 5, 1 - 3 / 2 - 4, 3 - 5 / 1 - 4, 2 - 5

BORBE	TAKMIČAR	BODOVA	BODOVA	TAKMIČAR	VREME
1 - 2	BANIKA, Marija Jugović, Kać	<b>100</b>	<b>0</b>	MALEŠ, Mia TSK Temerin, Temerin	0:41
3 - 4	FORGO, Andrea Spartak, Subotica	<b>0</b>	<b>100</b>	RADOVIĆ, Tatjana Sirig, Sirig	0:05
1 - 5	BANIKA, Marija Jugović, Kać	<b>100</b>	<b>0</b>	JOVANOVIĆ, Jovana Turija, Turija	0:13
2 - 3	MALEŠ, Mia TSK Temerin, Temerin	<b>100</b>	<b>0</b>	FORGO, Andrea Spartak, Subotica	0:03
4 - 5	RADOVIĆ, Tatjana Sirig, Sirig	<b>100</b>	<b>0</b>	JOVANOVIĆ, Jovana Turija, Turija	0:52
1 - 3	BANIKA, Marija Jugović, Kać	<b>100</b>	<b>0</b>	FORGO, Andrea Spartak, Subotica	0:10
2 - 4	MALEŠ, Mia TSK Temerin, Temerin	<b>10</b>	<b>0</b>	RADOVIĆ, Tatjana Sirig, Sirig	2:45
3 - 5	FORGO, Andrea Spartak, Subotica	<b>100</b>	<b>0</b>	JOVANOVIĆ, Jovana Turija, Turija	0:57
1 - 4	BANIKA, Marija Jugović, Kać	<b>100</b>	<b>0</b>	RADOVIĆ, Tatjana Sirig, Sirig	3:58
2 - 5	MALEŠ, Mia TSK Temerin, Temerin	<b>100</b>	<b>0</b>	JOVANOVIĆ, Jovana Turija, Turija	0:05

### REZULTAT

- |                      |     |
|----------------------|-----|
| 1. BANIKA, Marija    | JUG |
| 2. MALEŠ, Mia        | TSK |
| 3. RADOVIĆ, Tatjana  | SIR |
| 3. FORGO, Andrea     | SPA |
| 5. JOVANOVIĆ, Jovana | TUR |

# Regionalni Šampionat VOJVODINA - S.POLETARCI 2019

Stepanovićevo, 02.02.2019 - Starije poletarke

**-38kg**

4 takmičarki

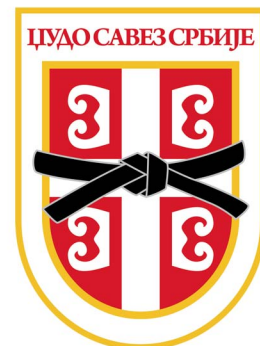

	TAKMIČAR	POBEDNIČKI BODOVI				POBEDA	BODOVA	MESTO
		1	2	3	4			
1	KARABAŠEVIĆ, Kalina Okami NS, Novi Sad		100	100	100	3	300	1
2	TERZIN, Jana Proleter MD, Zrenjanin	0		100	10	2	110	2
3	BUHA, Lena Džuns, Novi Sad	0	0		0	0	0	3
4	VARGA ŠOMOĐI, Ines TSK Temerin, Temerin	100	0	0		1	100	3

**Bodovi:** Ippon 100 / Wazaari 10 / Kazna 0.5

**Redosled borbi:** 1 - 2, 3 - 4 / 1 - 3, 2 - 4 / 1 - 4, 2 - 3

BORBE	TAKMIČAR	BODOVA	BODOVA	TAKMIČAR	VREME
1 - 2	KARABAŠEVIĆ, Kalina Okami NS, Novi Sad	<b>100</b>	<b>0</b>	TERZIN, Jana Proleter MD, Zrenjanin	1:40
3 - 4	BUHA, Lena Džuns, Novi Sad	<b>0</b>	<b>100</b>	VARGA ŠOMOĐI, Ines TSK Temerin, Temerin	0:54
1 - 3	KARABAŠEVIĆ, Kalina Okami NS, Novi Sad	<b>100</b>	<b>0</b>	BUHA, Lena Džuns, Novi Sad	0:08
2 - 4	TERZIN, Jana Proleter MD, Zrenjanin	<b>10</b>	<b>0</b>	VARGA ŠOMOĐI, Ines TSK Temerin, Temerin	1:59
1 - 4	KARABAŠEVIĆ, Kalina Okami NS, Novi Sad	<b>100</b>	<b>0</b>	VARGA ŠOMOĐI, Ines TSK Temerin, Temerin	0:06
2 - 3	TERZIN, Jana Proleter MD, Zrenjanin	<b>100</b>	<b>0</b>	BUHA, Lena Džuns, Novi Sad	1:12

## REZULTAT

1. KARABAŠEVIĆ, Kalina OKA  
 2. TERZIN, Jana PRO  
 3. VARGA ŠOMOĐI, Ines TSK  
 3. BUHA, Lena DZU



# Regionalni Šampionat VOJVODINA - S.POLETARCI 2019

Stepanovićevo, 02.02.2019 - Starije poletarke

**-43kg**

3 takmičarke



	TAKMIČAR	POBEDNIČKI BODOVI			POBEDA	BODOVA	MESTO
		1	2	3			
1	JOKIĆ, Dunja TSK Temerin, Temerin		100	100	2	200	1
2	PROTIĆ, Elena Borac, Novi Sad	0		100	1	100	2
3	MEZEI, Emina Spartak, Subotica	0	0		0	0	3

**BODOVI:** Ippon 100 / Wazaari 10 / Kazna 0.5

**Redosled borbi:** 1 - 2 / 1 - 3 / 2 - 3

BORBE	TAKMIČAR	BODOVA	BODOVA	TAKMIČAR	VREME
1 - 2	JOKIĆ, Dunja TSK Temerin, Temerin	100	0	PROTIĆ, Elena Borac, Novi Sad	0:15
1 - 3	JOKIĆ, Dunja TSK Temerin, Temerin	100	0	MEZEI, Emina Spartak, Subotica	0:49
2 - 3	PROTIĆ, Elena Borac, Novi Sad	100	0	MEZEI, Emina Spartak, Subotica	0:42

## REZULTAT

1. JOKIĆ, Dunja TSK  
2. PROTIĆ, Elena BNS  
3. MEZEI, Emina SPA

# Regionalni Šampionat VOJVODINA - S.POLETARCI 2019

Stepanovićevo, 02.02.2019 - Starije poletarke

**+43kg**

2 takmičarke

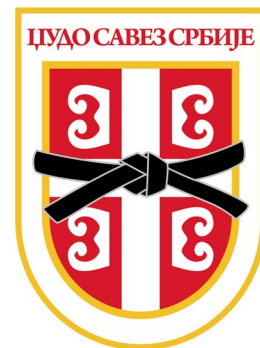

BORBE	TAKMIČAR	BODOVA	BODOVA	TAKMIČAR	VREME
1 - 2	ROMELIĆ, Iva TSK Temerin, Temerin	100	0	ĆELBABIN, Mirjana Turija, Turija	0:38
1 - 2	ROMELIĆ, Iva TSK Temerin, Temerin	100	0	ĆELBABIN, Mirjana Turija, Turija	0:48
<del>1 - 2</del>	<del>ROMELIĆ, Iva TSK Temerin, Temerin</del>			<del>ĆELBABIN, Mirjana Turija, Turija</del>	

Bodovi: Ippon 100 / Wazaari 10 / Kazna 0.5

Kriterijum za određivanje pobednika: Dve pobjede

## REZULTAT

1. ROMELIĆ, Iva TSK  
2. ĆELBABIN, Mirjana TUR