

Regionalni Šampionat BEOGRAD - KADETI 2019

Beograd, 09.02.2019 - Kadeti



-50kg

6 takmičara

| BORBE | TAKMIČAR | BODOVA | BODOVA | TAKMIČAR | VREME |
|-------|--|------------|------------|--|-------|
| 1 - 2 | POPOVIĆ, Mateja Vinča, Beograd | 100 | 0 | TRAILOVIĆ, Filip Institut za džudo, Beograd | 1:39 |
| 1 - 3 | POPOVIĆ, Mateja Vinča, Beograd | 0 | 10 | PAUNOVIĆ, Nikola ODŽK Beograd, Beograd | 3:59 |
| 2 - 3 | TRAILOVIĆ, Filip Institut za džudo, Beograd | 0 | 100 | PAUNOVIĆ, Nikola ODŽK Beograd, Beograd | 1:47 |

| | | | | | |
|-----------------------|-----|---|-----------------------|---|-------------|
| [A1] PAUNOVIĆ, Nikola | OJK | 7 | PAUNOVIĆ, Nikola | 9 | NAĐ, Nikola |
| [B2] LOJANIČIĆ, Marko | RAK | | ODŽK Beograd, Beograd | | |
| [B1] NAĐ, Nikola | MZE | 8 | NAĐ, Nikola | | |
| [A2] POPOVIĆ, Mateja | VIN | | | | |

| BORBE | TAKMIČAR | BODOVA | BODOVA | TAKMIČAR | VREME |
|-------|--|-----------|------------|---------------------------------------|-------|
| 4 - 5 | JORDANOV, Luka Trudbenik KORTEGA, Beograd | 0 | 100 | LOJANIČIĆ, Marko Rakovica, Beograd | 3:43 |
| 4 - 6 | JORDANOV, Luka Trudbenik KORTEGA, Beograd | 10 | 0 | NAĐ, Nikola Mladost Zemun, Beograd | 4:44 |
| 5 - 6 | LOJANIČIĆ, Marko Rakovica, Beograd | 0 | 100 | NAĐ, Nikola Mladost Zemun, Beograd | 2:02 |

BODOVI: Ippon 100 / Wazaari 10 / Kazna 0.5

Redosled borbi: 1 - 2 / 4 - 5 / 1 - 3 / 4 - 6 / 2 - 3 / 5 - 6

REZULTAT

| | |
|---------------------|-----|
| 1. NAĐ, Nikola | MZE |
| 2. PAUNOVIĆ, Nikola | OJK |
| 3. LOJANIČIĆ, Marko | RAK |
| 3. POPOVIĆ, Mateja | VIN |
| 5. TRAILOVIĆ, Filip | IZJ |
| 5. JORDANOV, Luka | TKS |

Regionalni Šampionat BEOGRAD - KADETI 2019

Beograd, 09.02.2019 - Kadeti



-55kg

5 takmičara

| | TAKMIČAR | POBEDNIČKI BODOVI | | | | | POBEDA | BODOVA | MESTO |
|---|--|-------------------|----|-----|-----|-----|--------|--------|-------|
| | | 1 | 2 | 3 | 4 | 5 | | | |
| 1 | POPOVIĆ, Luka Makikomi, Beograd | | 10 | 100 | 100 | 100 | 4 | 310 | 1 |
| 2 | ILIC, Vuk ODŽK Beograd, Beograd | 0 | | 100 | 100 | 100 | 3 | 300 | 2 |
| 3 | JOVANOVIĆ, Nemanja Rakovica, Beograd | 0 | 0 | | 0 | 100 | 1 | 100 | 3 |
| 4 | GAČIĆ, Vukašin Crvena Zvezda, Beograd | 0 | 0 | 100 | | 100 | 2 | 200 | 3 |
| 5 | MILANOVIĆ, Marko Sveti Đorđe, Beograd | 0 | 0 | 0 | 0 | | 0 | 0 | 5 |

Bodovi: Ippon 100 / Wazaari 10 / Kazna 0.5

Redosled borbi: 1 - 2, 3 - 4 / 1 - 5, 2 - 3 / 4 - 5, 1 - 3 / 2 - 4, 3 - 5 / 1 - 4, 2 - 5

| BORBE | TAKMIČAR | BODOVA | BODOVA | TAKMIČAR | VREME |
|-------|--|------------|------------|--|-------|
| 1 - 2 | POPOVIĆ, Luka Makikomi, Beograd | 10 | 0 | ILIC, Vuk ODŽK Beograd, Beograd | 3:59 |
| 3 - 4 | JOVANOVIĆ, Nemanja Rakovica, Beograd | 0 | 100 | GAČIĆ, Vukašin Crvena Zvezda, Beograd | 1:21 |
| 1 - 5 | POPOVIĆ, Luka Makikomi, Beograd | 100 | 0 | MILANOVIĆ, Marko Sveti Đorđe, Beograd | 0:56 |
| 2 - 3 | ILIC, Vuk ODŽK Beograd, Beograd | 100 | 0 | JOVANOVIĆ, Nemanja Rakovica, Beograd | 0:36 |
| 4 - 5 | GAČIĆ, Vukašin Crvena Zvezda, Beograd | 100 | 0 | MILANOVIĆ, Marko Sveti Đorđe, Beograd | 1:22 |
| 1 - 3 | POPOVIĆ, Luka Makikomi, Beograd | 100 | 0 | JOVANOVIĆ, Nemanja Rakovica, Beograd | 0:35 |
| 2 - 4 | ILIC, Vuk ODŽK Beograd, Beograd | 100 | 0 | GAČIĆ, Vukašin Crvena Zvezda, Beograd | 1:44 |
| 3 - 5 | JOVANOVIĆ, Nemanja Rakovica, Beograd | 100 | 0 | MILANOVIĆ, Marko Sveti Đorđe, Beograd | 1:53 |
| 1 - 4 | POPOVIĆ, Luka Makikomi, Beograd | 100 | 0 | GAČIĆ, Vukašin Crvena Zvezda, Beograd | 5:33 |
| 2 - 5 | ILIC, Vuk ODŽK Beograd, Beograd | 100 | 0 | MILANOVIĆ, Marko Sveti Đorđe, Beograd | 0:53 |

REZULTAT

| | |
|-----------------------|-----|
| 1. POPOVIĆ, Luka | MAK |
| 2. ILIC, Vuk | OJK |
| 3. GAČIĆ, Vukašin | CZB |
| 3. JOVANOVIĆ, Nemanja | RAK |
| 5. MILANOVIĆ, Marko | SVD |

Regionalni Šampionat BEOGRAD - KADETI 2019

Beograd, 09.02.2019 - Kadeti



-60kg

15 takmičara

GRUPA A

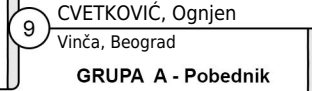
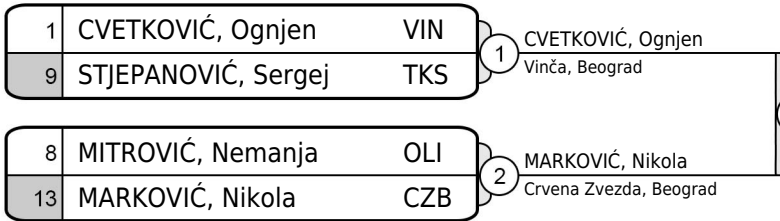

GRUPA B

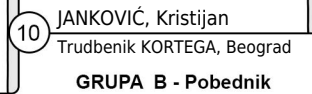
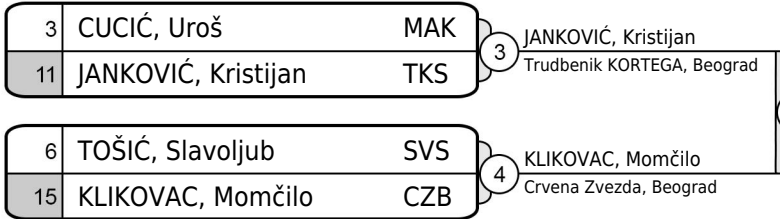

GRUPA C

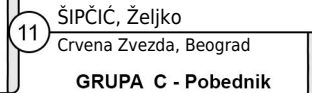
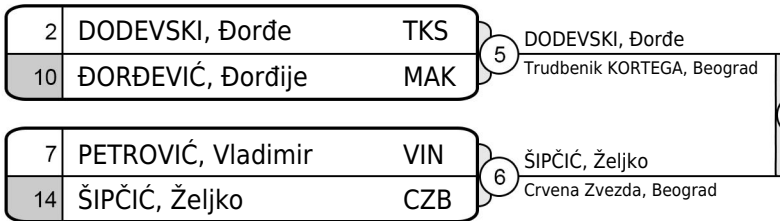

GRUPA D

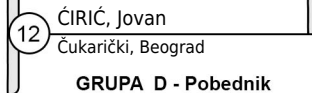
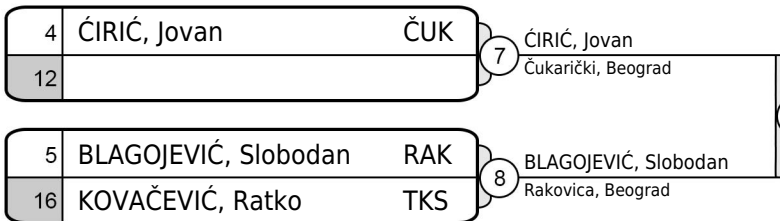

ĆIRIĆ, Jovan

1.

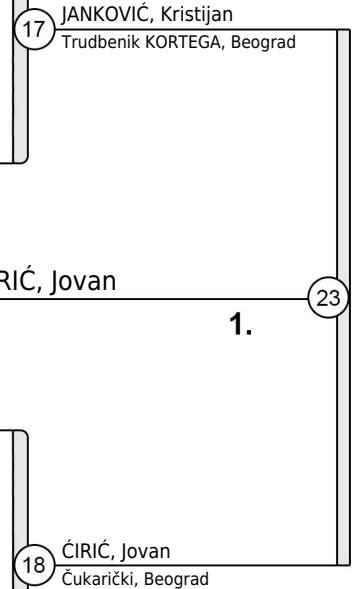

REZULTAT

| | | |
|----|----------------------|-----|
| 1. | ĆIRIĆ, Jovan | ČUK |
| 2. | JANKOVIĆ, Kristijan | TKS |
| 3. | ŠIPČIĆ, Željko | CZB |
| 4. | CVETKOVIĆ, Ognjen | VIN |
| 5. | MARKOVIĆ, Nikola | CZB |
| 6. | DODEVSKI, Đorđe | TKS |
| 7. | CUCIĆ, Uroš | MAK |
| 8. | BLAGOJEVIĆ, Slobodan | RAK |

REPASAŽ

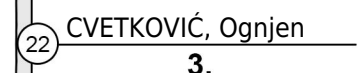
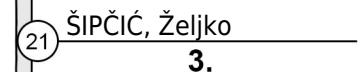
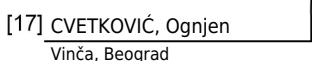
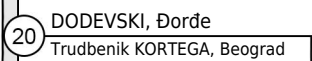
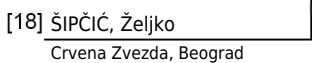
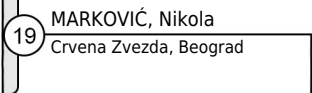
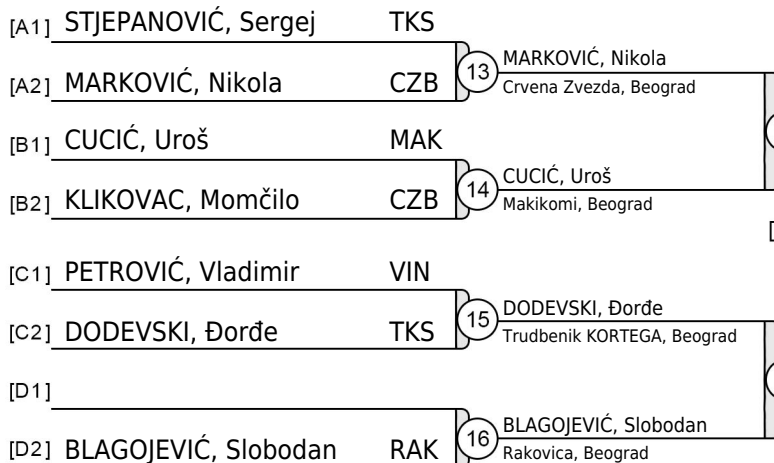

Regionalni Šampionat BEOGRAD - KADETI 2019

Beograd, 09.02.2019 - Kadeti



-66kg

15 takmičara

GRUPA A

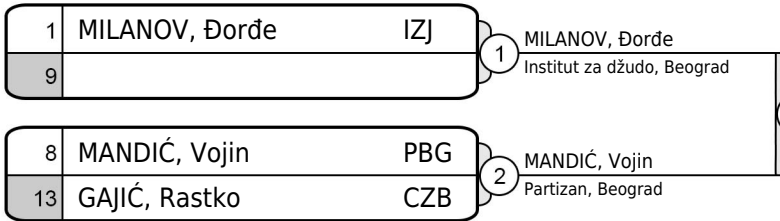

9 MILANOV, Đorđe
Institut za džudo, Beograd
GRUPA A - Pobjednik

GRUPA B

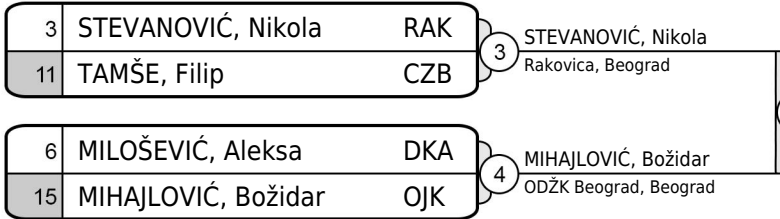

10 STEVANOVIĆ, Nikola
Rakovica, Beograd
GRUPA B - Pobjednik

GRUPA C

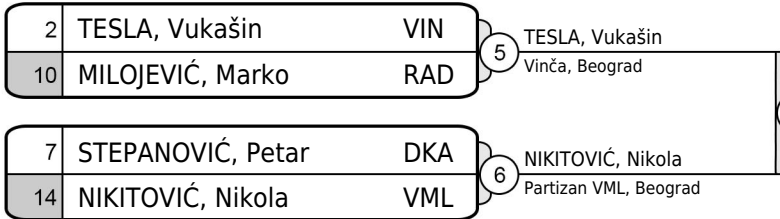

11 TESLA, Vukašin
Vinča, Beograd
GRUPA C - Pobjednik

GRUPA D

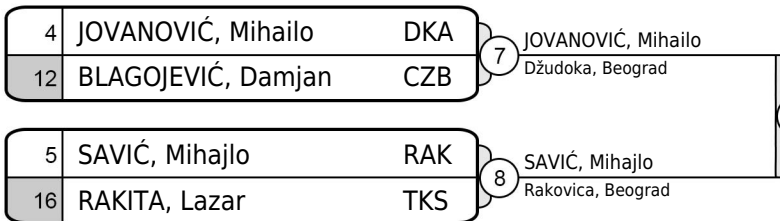

12 SAVIĆ, Mihajlo
Rakovica, Beograd
GRUPA D - Pobjednik

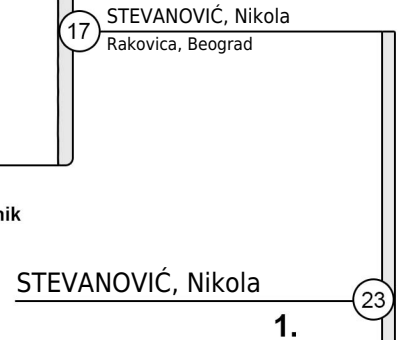

REZULTAT

| | | |
|----|---------------------|-----|
| 1. | STEVANOVIĆ, Nikola | RAK |
| 2. | SAVIĆ, Mihajlo | RAK |
| 3. | TESLA, Vukašin | VIN |
| 4. | MILANOV, Đorđe | IZJ |
| 5. | MIHAJLOVIĆ, Božidar | OJK |
| 6. | NIKITTOVIĆ, Nikola | VML |
| 7. | MANDIĆ, Vojin | PBG |
| 8. | JOVANOVIĆ, Mihailo | DKA |

REPASAŽ

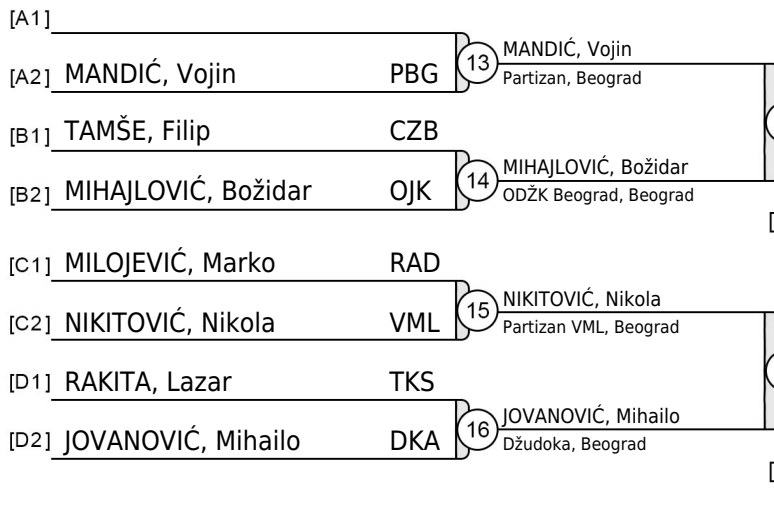

19 MIHAJLOVIĆ, Božidar
ODŽK Beograd, Beograd

21 TESLA, Vukašin
Vinča, Beograd

18 TESLA, Vukašin
Vinča, Beograd

20 NIKITTOVIĆ, Nikola
Partizan VML, Beograd

22 MILANOV, Đorđe
Institut za džudo, Beograd

17 MILANOV, Đorđe
Institut za džudo, Beograd

21 TESLA, Vukašin
3.

22 MILANOV, Đorđe
3.

Regionalni Šampionat BEOGRAD - KADETI 2019

Beograd, 09.02.2019 - Kadeti



-73kg

17 takmičara

GRUPA A

| | | |
|----|--------------------|-----|
| 1 | RAJČIĆ, Aleksandar | PBG |
| 17 | | |
| 9 | IVANIĆ, Aleksa | CZB |
| 25 | | |
| 5 | LOJANIČIĆ, Stefan | RAK |
| 21 | | |
| 13 | PEJIĆ, Mihailo | MAK |
| 29 | | |

| | | |
|----|--------------------|------------------------|
| 1 | RAJČIĆ, Aleksandar | Partizan, Beograd |
| 2 | IVANIĆ, Aleksa | Crvena Zvezda, Beograd |
| 3 | LOJANIČIĆ, Stefan | Rakovica, Beograd |
| 4 | PEJIĆ, Mihailo | Makikomi, Beograd |
| 17 | RAJČIĆ, Aleksandar | Partizan, Beograd |
| 18 | LOJANIČIĆ, Stefan | Rakovica, Beograd |
| 25 | RAJČIĆ, Aleksandar | Partizan, Beograd |

GRUPA A - Pobjednik

GRUPA B

| | | |
|----|--------------------|-----|
| 4 | ŠAPIĆ, Nikola | IZJ |
| 20 | | |
| 12 | JOVANOVIĆ, Stefan | RAK |
| 28 | | |
| 8 | ČEVIZOVIĆ, Uroš | OJK |
| 24 | | |
| 16 | NOVOVIĆ, Vukašin | CZB |
| 32 | VESELINOVIĆ, Lazar | RAK |

| | | |
|----|--------------------|----------------------------|
| 5 | ŠAPIĆ, Nikola | Institut za džudo, Beograd |
| 6 | JOVANOVIĆ, Stefan | Rakovica, Beograd |
| 7 | ČEVIZOVIĆ, Uroš | ODŽK Beograd, Beograd |
| 8 | VESELINOVIĆ, Lazar | Rakovica, Beograd |
| 19 | JOVANOVIĆ, Stefan | Rakovica, Beograd |
| 20 | ČEVIZOVIĆ, Uroš | ODŽK Beograd, Beograd |
| 26 | JOVANOVIĆ, Stefan | Rakovica, Beograd |

GRUPA B - Pobjednik

GRUPA C

| | | |
|----|------------------|-----|
| 2 | BANJAC, Đorđe | VIN |
| 18 | | |
| 10 | POČUČA, Miloš | RAK |
| 26 | | |
| 6 | DRAKULIĆ, Ilija | ČUK |
| 22 | | |
| 14 | KOPRIVICA, Marko | OLI |
| 30 | | |

| | | |
|----|------------------|--------------------|
| 9 | BANJAC, Đorđe | Vinča, Beograd |
| 10 | POČUČA, Miloš | Rakovica, Beograd |
| 11 | DRAKULIĆ, Ilija | Čukarički, Beograd |
| 12 | KOPRIVICA, Marko | Olimp, Beograd |
| 21 | POČUČA, Miloš | Rakovica, Beograd |
| 22 | DRAKULIĆ, Ilija | Čukarički, Beograd |
| 27 | DRAKULIĆ, Ilija | Čukarički, Beograd |

GRUPA C - Pobjednik

GRUPA D

| | | |
|----|----------------------|-----|
| 3 | JOVANOVIĆ, Dimitrije | IZJ |
| 19 | | |
| 11 | DAMNJANOVIĆ, Đorđe | SVS |
| 27 | | |
| 7 | PAVLOVIĆ, Ognjen | RAK |
| 23 | | |
| 15 | PROKOPIJEVIĆ, Luka | CZB |
| 31 | | |

| | | |
|----|----------------------|----------------------------|
| 13 | JOVANOVIĆ, Dimitrije | Institut za džudo, Beograd |
| 14 | DAMNJANOVIĆ, Đorđe | Sveta Srbija, Beograd |
| 15 | PAVLOVIĆ, Ognjen | Rakovica, Beograd |
| 16 | PROKOPIJEVIĆ, Luka | Crvena Zvezda, Beograd |
| 23 | JOVANOVIĆ, Dimitrije | Institut za džudo, Beograd |
| 24 | PROKOPIJEVIĆ, Luka | Crvena Zvezda, Beograd |
| 28 | PROKOPIJEVIĆ, Luka | Crvena Zvezda, Beograd |

GRUPA D - Pobjednik

RAJČIĆ, Aleksandar

1.

43

PROKOPIJEVIĆ, Luka
Crvena Zvezda, Beograd

| REZULTAT | |
|----------|------------------------|
| 1. | RAJČIĆ, Aleksandar PBG |
| 2. | PROKOPIJEVIĆ, Luka CZB |
| 3. | LOJANIČIĆ, Stefan RAK |
| 3. | JOVANOVIĆ, Stefan RAK |
| 5. | DRAKULIĆ, Ilija ČUK |
| 7. | PAVLOVIĆ, Ognjen RAK |
| 7. | ČEVIZOVIĆ, Uroš OJK |
| 7. | POČUČA, Miloš RAK |

REPASAŽ

| | | | | | |
|------|----------------------|-----|----|-------------------|----|
| [A1] | | | | | |
| [A2] | IVANIĆ, Aleksa | CZB | 29 | LOJANIČIĆ, Stefan | 33 |
| [B1] | | | | | |
| [B2] | ŠAPIĆ, Nikola | IZJ | 30 | ČEVIZOVIĆ, Uroš | 34 |
| [C1] | | | | | |
| [C2] | KOPRIVICA, Marko | OLI | 31 | POČUČA, Miloš | 35 |
| [D1] | | | | | |
| [D2] | PAVLOVIĆ, Ognjen | RAK | 32 | PAVLOVIĆ, Ognjen | 40 |
| [D3] | JOVANOVIĆ, Dimitrije | | 36 | JOVANOVIĆ, Stefan | 42 |

3.

3.

Regionalni Šampionat BEOGRAD - KADETI 2019

Beograd, 09.02.2019 - Kadeti



-81kg

10 takmičara

GRUPA A

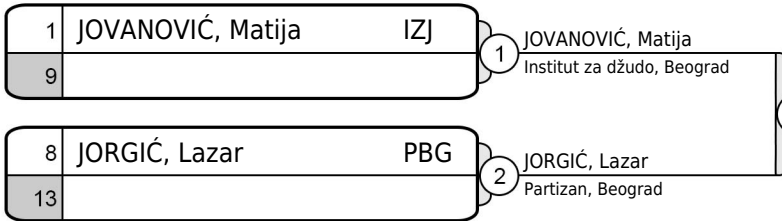

9 JORGIĆ, Lazar
Partizan, Beograd
GRUPA A - Pobjednik

GRUPA B

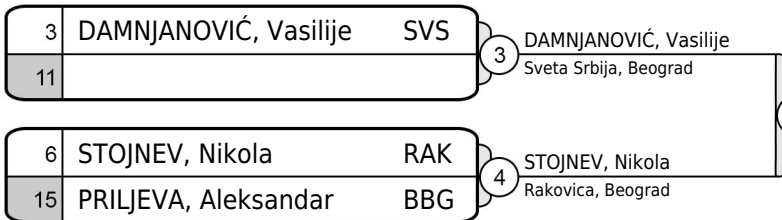

10 STOJNEV, Nikola
Rakovica, Beograd
GRUPA B - Pobjednik

GRUPA C

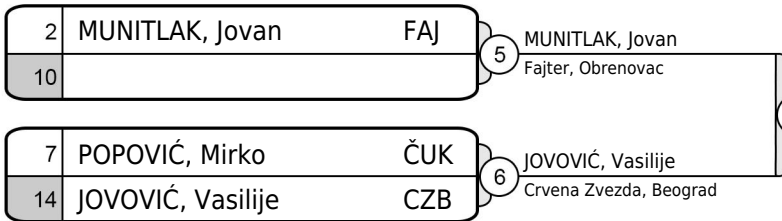

11 JOVOVIĆ, Vasilije
Crvena Zvezda, Beograd
GRUPA C - Pobjednik

GRUPA D

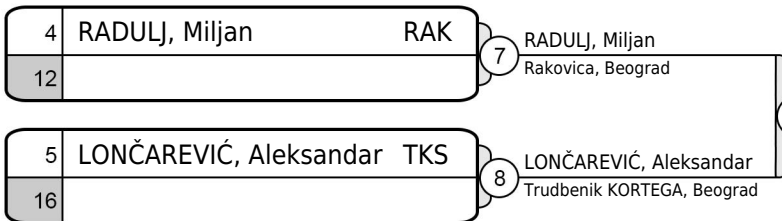

12 RADULJ, Miljan
Rakovica, Beograd
GRUPA D - Pobjednik

RADULJ, Miljan

1.

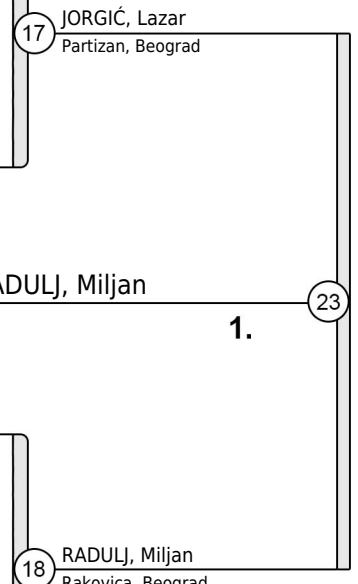

REZULTAT

- | | | |
|----|------------------------|-----|
| 1. | RADULJ, Miljan | RAK |
| 2. | JORGIĆ, Lazar | PBG |
| 3. | JOVOVIĆ, Vasilije | CZB |
| 3. | STOJNEV, Nikola | RAK |
| 5. | JOVANOVIĆ, Matija | IZJ |
| 5. | MUNITLAK, Jovan | FAJ |
| 7. | PRILJEVA, Aleksandar | BBG |
| 7. | LONČAREVIĆ, Aleksandar | TKS |

REPASAŽ



19 JOVANOVIĆ, Matija
Institut za džudo, Beograd

21 JOVOVIĆ, Vasilije
Crvena Zvezda, Beograd

18 JOVOVIĆ, Vasilije
Crvena Zvezda, Beograd

20 MUNITLAK, Jovan
Fajter, Obrenovac

22 STOJNEV, Nikola
Rakovica, Beograd

17 STOJNEV, Nikola
Rakovica, Beograd

Regionalni Šampionat BEOGRAD - KADETI 2019

Beograd, 09.02.2019 - Kadeti

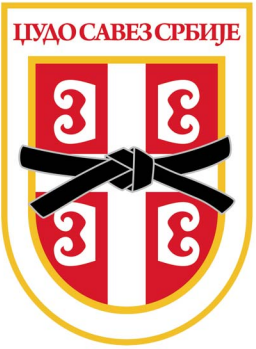

-90kg

8 takmičara

GRUPA A

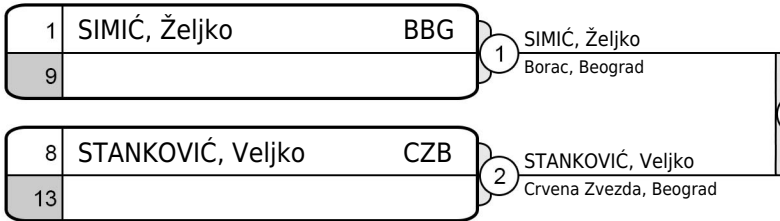

GRUPA B

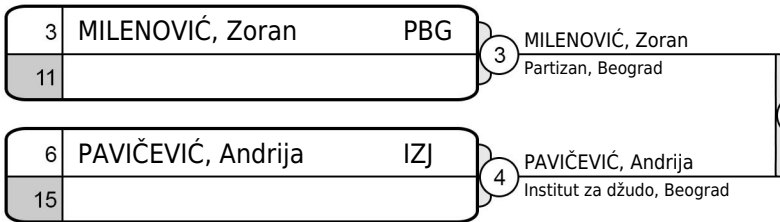

GRUPA C

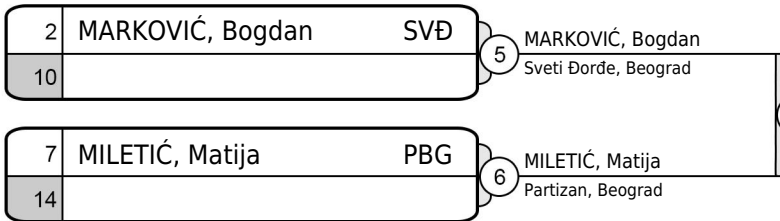

GRUPA D

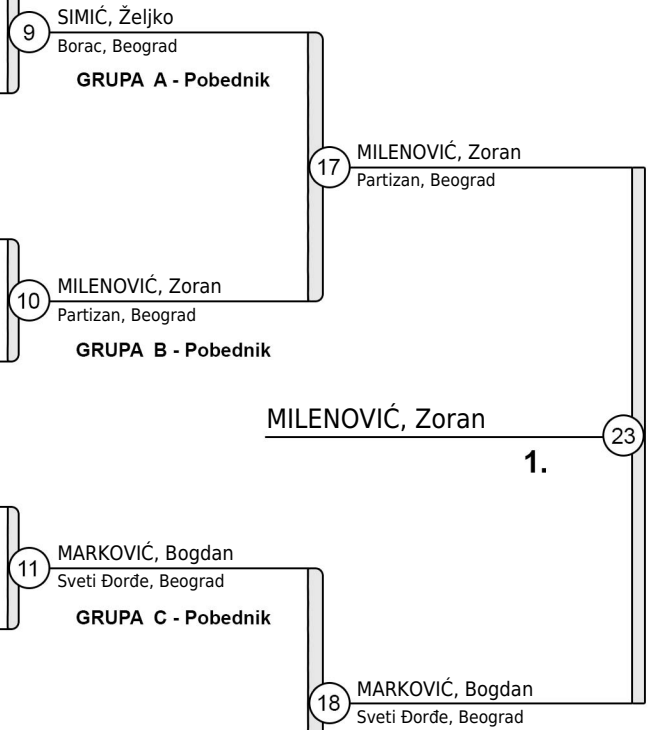
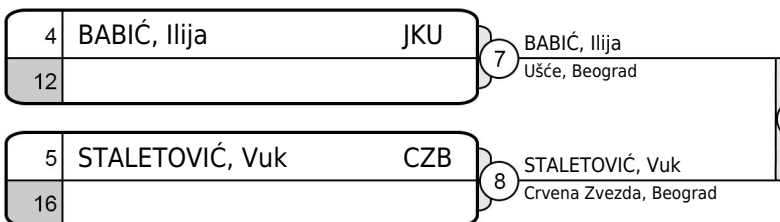

MILENOVIĆ, Zoran

1.

REZULTAT

| | | |
|----|--------------------|-----|
| 1. | MILENOVIĆ, Zoran | PBG |
| 2. | MARKOVIĆ, Bogdan | SVĐ |
| 3. | STANKOVIĆ, Veljko | CZB |
| 3. | SIMIĆ, Željko | BBG |
| 5. | BABIĆ, Ilija | JKU |
| 5. | MILETIĆ, Matija | PBG |
| 7. | PAVIČEVIĆ, Andrija | IZJ |
| 7. | STALETOVIĆ, Vuk | CZB |

REPASAŽ

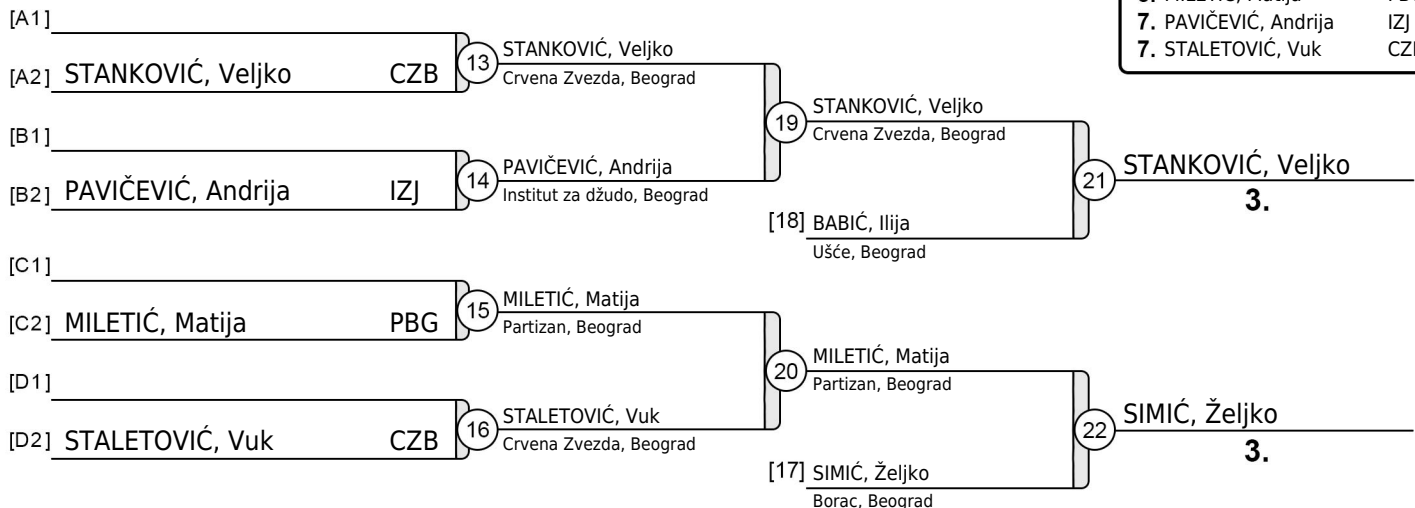

Regionalni Šampionat BEOGRAD - KADETI 2019

Beograd, 09.02.2019 - Kadeti



+90kg

6 takmičara

| BORBE | TAKMIČAR | BODOVA | BODOVA | TAKMIČAR | VREME |
|-------|---|------------|----------|---|-------|
| 1 - 2 | HADZOVIĆ, Ognjen ODŽK Beograd, Beograd | 100 | 0 | MARIČIĆ, Nikola Crvena Zvezda, Beograd | 2:55 |
| 1 - 3 | HADZOVIĆ, Ognjen ODŽK Beograd, Beograd | 100 | 0 | MRDAKOVIĆ, Miloš Rakovica, Beograd | 0:39 |
| 2 - 3 | MARIČIĆ, Nikola Crvena Zvezda, Beograd | 100 | 0 | MRDAKOVIĆ, Miloš Rakovica, Beograd | 2:30 |

| | | | | | | |
|------|------------------|-----|---|------------------------|---|--|
| [A1] | HADZOVIĆ, Ognjen | OJK | 7 | HADZOVIĆ, Ognjen | 9 | BOGOVAC, Vuk Crvena Zvezda, Beograd |
| [B2] | NEKVASIL, Stefan | MAK | | ODŽK Beograd, Beograd | | |
| [B1] | BOGOVAC, Vuk | CZB | 8 | BOGOVAC, Vuk | 9 | BOGOVAC, Vuk Crvena Zvezda, Beograd |
| [A2] | MARIČIĆ, Nikola | CZB | | Crvena Zvezda, Beograd | | |

| BORBE | TAKMIČAR | BODOVA | BODOVA | TAKMIČAR | VREME |
|-------|--|------------|----------|--|-------|
| 4 - 5 | BOGOVAC, Vuk Crvena Zvezda, Beograd | 100 | 0 | NEKVASIL, Stefan Makikomi, Beograd | 1:42 |
| 4 - 6 | BOGOVAC, Vuk Crvena Zvezda, Beograd | 100 | 0 | ANDJELOVIĆ, Luka Trudbenik KORTEGA, Beograd | 0:36 |
| 5 - 6 | NEKVASIL, Stefan Makikomi, Beograd | 100 | 0 | ANDJELOVIĆ, Luka Trudbenik KORTEGA, Beograd | 7:16 |

BODOVI: Ippon 100 / Wazaari 10 / Kazna 0.5

Redosled borbi: 1 - 2 / 4 - 5 / 1 - 3 / 4 - 6 / 2 - 3 / 5 - 6

REZULTAT

| | | |
|----|------------------|-----|
| 1. | BOGOVAC, Vuk | CZB |
| 2. | HADZOVIĆ, Ognjen | OJK |
| 3. | NEKVASIL, Stefan | MAK |
| 3. | MARIČIĆ, Nikola | CZB |
| 5. | MRDAKOVIĆ, Miloš | RAK |
| 5. | ANDJELOVIĆ, Luka | TKS |

Regionalni Šampionat BEOGRAD - KADETI 2019

Beograd, 09.02.2019 - Kadetkinje



-40kg
0 takmičarki

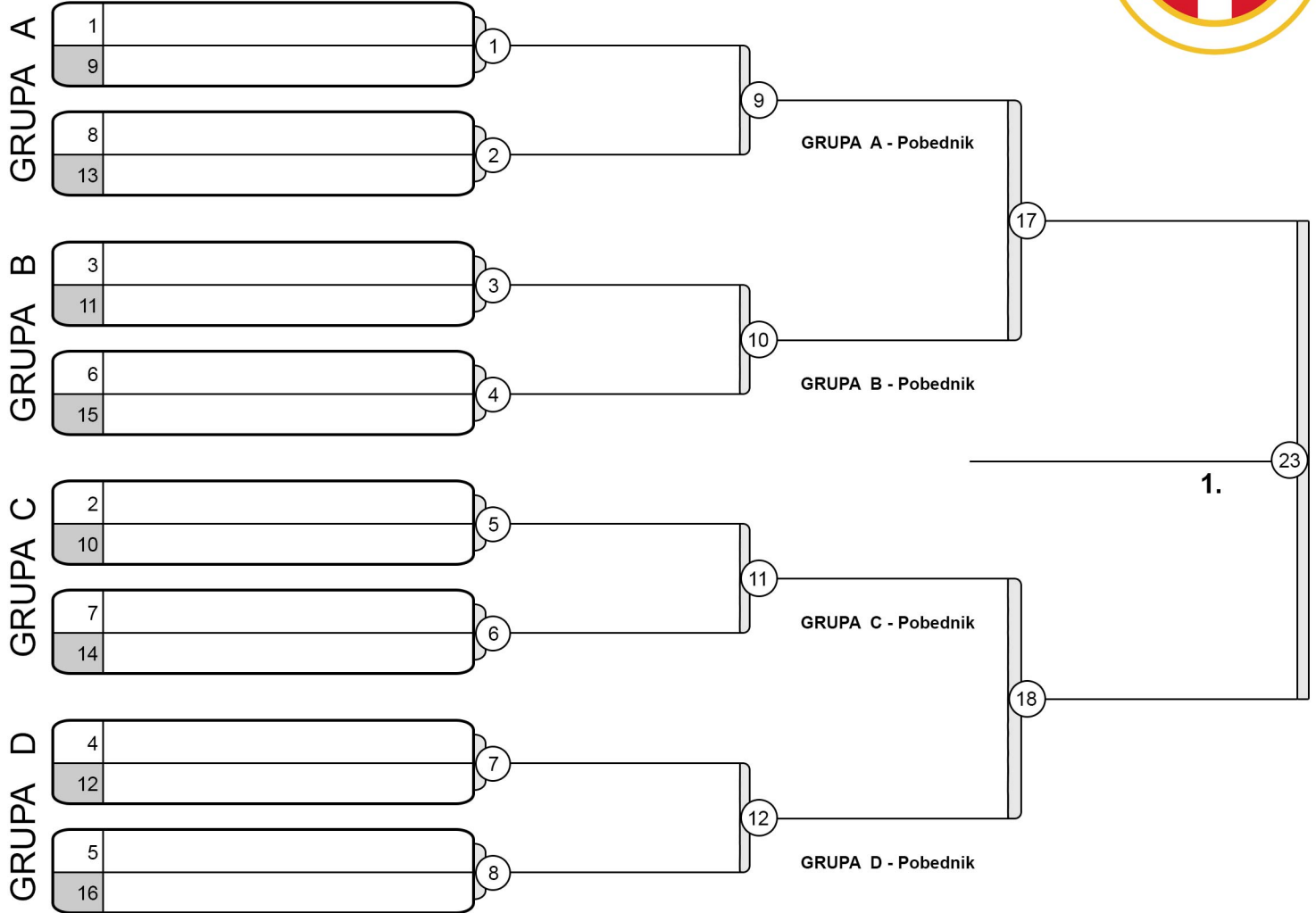

REZULTAT

- 1.
- 2.
- 3.
- 3.
- 5.
- 7.
- 7.

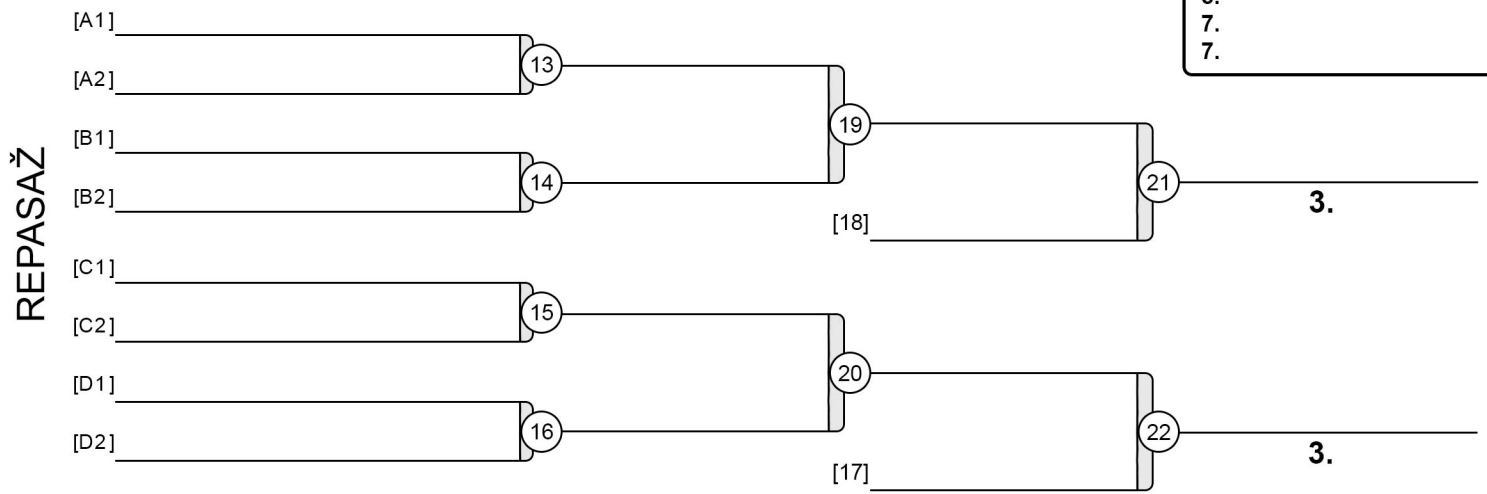

Regionalni Šampionat BEOGRAD - KADETI 2019

Beograd, 09.02.2019 - Kadetkinje

-44kg

1 takmičarka



REZULTAT

1. MAJSTORVIĆ, Anica VOŽ

Regionalni Šampionat BEOGRAD - KADETI 2019

Beograd, 09.02.2019 - Kadetkinje

-48kg

3 takmičarke



| | TAKMIČAR | POBEDNIČKI BODOVI | | | POBEDA | BODOVA | MESTO |
|----------|--|-------------------|-----|-----|--------|--------|-------|
| | | 1 | 2 | 3 | | | |
| 1 | MILANOVIĆ, Milica Rakovica, Beograd | | 100 | 100 | 2 | 200 | 1 |
| 2 | MARKOVIĆ, Kristina ODŽK Beograd, Beograd | 0 | | 100 | 1 | 100 | 2 |
| 3 | BOGOJEVIĆ, Natalija ODŽK Beograd, Beograd | 0 | 0 | | 0 | 0 | 3 |

BODOVI: Ippon 100 / Wazaari 10 / Kazna 0.5

Redosled borbi: 1 - 2 / 1 - 3 / 2 - 3

| BORBE | TAKMIČAR | BODOVA | BODOVA | TAKMIČAR | VREME |
|-------|---|------------|----------|--|-------|
| 1 - 2 | MILANOVIĆ, Milica Rakovica, Beograd | 100 | 0 | MARKOVIĆ, Kristina ODŽK Beograd, Beograd | 1:59 |
| 1 - 3 | MILANOVIĆ, Milica Rakovica, Beograd | 100 | 0 | BOGOJEVIĆ, Natalija ODŽK Beograd, Beograd | 0:08 |
| 2 - 3 | MARKOVIĆ, Kristina ODŽK Beograd, Beograd | 100 | 0 | BOGOJEVIĆ, Natalija ODŽK Beograd, Beograd | 1:02 |

REZULTAT

- | | |
|-------------------------------|-----|
| 1. MILANOVIĆ, Milica | RAK |
| 2. MARKOVIĆ, Kristina | OJK |
| 3. BOGOJEVIĆ, Natalija | OJK |

Regionalni Šampionat BEOGRAD - KADETI 2019

Beograd, 09.02.2019 - Kadetkinje



-52kg

7 takmičarki

GRUPA A

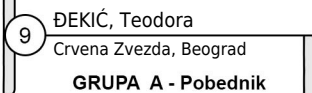
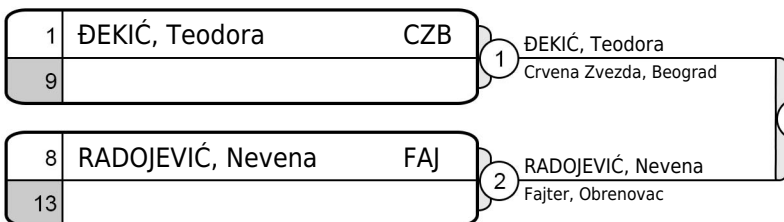

GRUPA B

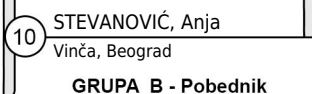
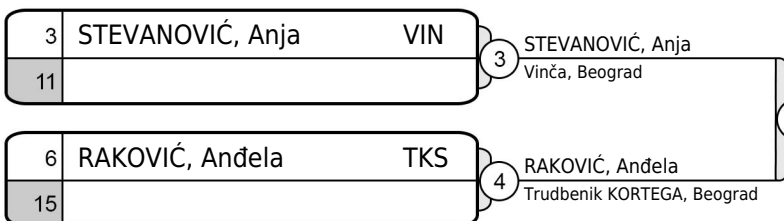

GRUPA C

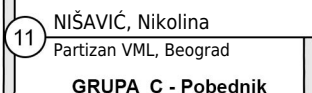
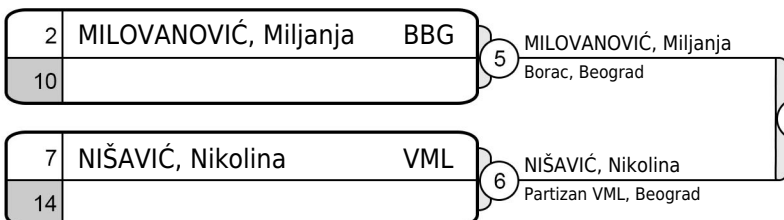

GRUPA D

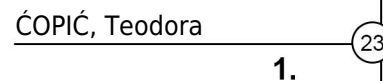
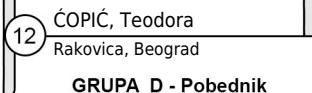
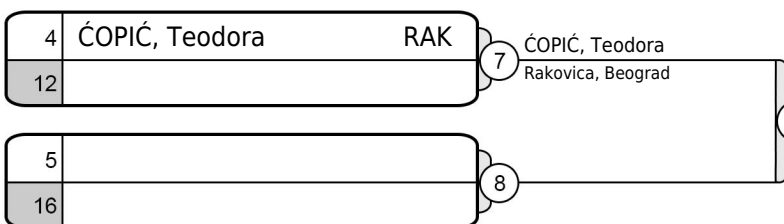

| REZULTAT | |
|----------|---------------------------|
| 1. | ĆOPIĆ, Teodora RAK |
| 2. | STEVANOVIĆ, Anja VIN |
| 3. | NIŠAVIĆ, Nikolina VML |
| 3. | MILOVANOVIĆ, Miljanja BBG |
| 5. | RAKOVIĆ, Anđela TKS |
| 5. | ĐEKIĆ, Teodora CZB |
| 7. | RADOJEVIĆ, Nevena FAJ |
| 7. | |

REPASAŽ

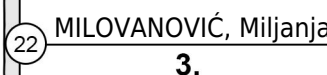
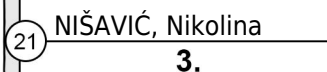
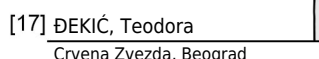
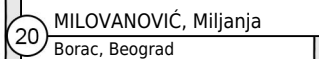
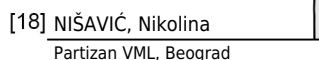
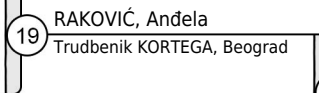
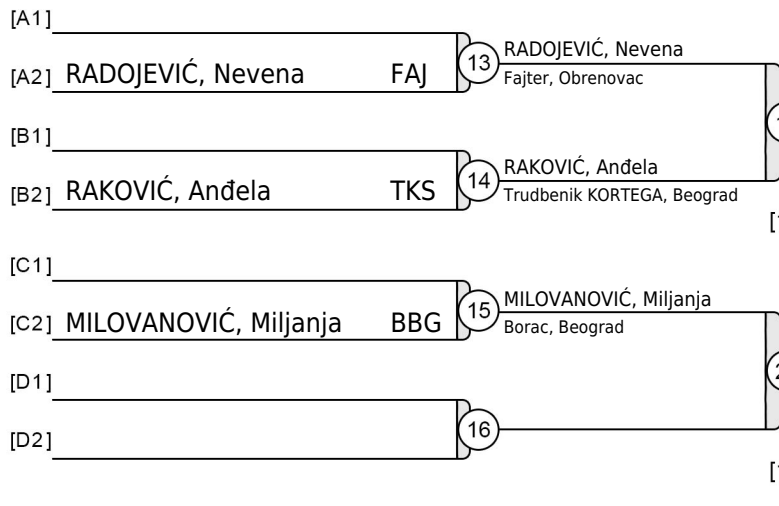

Regionalni Šampionat BEOGRAD - KADETI 2019

Beograd, 09.02.2019 - Kadetkinje

ДЖУДО САВЕЗ СРБИЈЕ



-57kg

5 takmičarki

| | TAKMIČAR | POBEDNIČKI BODOVI | | | | | POBEDA | BODOVA | MESTO |
|---|---|-------------------|-----|-----|-----|-----|--------|--------|-------|
| | | 1 | 2 | 3 | 4 | 5 | | | |
| 1 | MIRKOV, Dunja Voždovac, Beograd | | 100 | 100 | 100 | 100 | 4 | 400 | 1 |
| 2 | BOŽANOVIĆ, Emilija ODŽK Beograd, Beograd | 0 | | 100 | 0 | 100 | 2 | 200 | 3 |
| 3 | TOŠIĆ, Slađana Sveta Srbija, Beograd | 0 | 0 | | 0 | 0 | 0 | 0 | 5 |
| 4 | DOMAZET, Tamara Partizan VML, Beograd | 0 | 100 | 100 | | 100 | 3 | 300 | 2 |
| 5 | MARIĆ, Katarina Crvena Zvezda, Beograd | 0 | 0 | 100 | 0 | | 1 | 100 | 3 |

Bodovi: Ippon 100 / Wazaari 10 / Kazna 0.5

Redosled borbi: 1 - 2, 3 - 4 / 1 - 5, 2 - 3 / 4 - 5, 1 - 3 / 2 - 4, 3 - 5 / 1 - 4, 2 - 5

| BORBE | TAKMIČAR | BODOVA | BODOVA | TAKMIČAR | VREME |
|-------|---|------------|------------|---|-------|
| 1 - 2 | MIRKOV, Dunja Voždovac, Beograd | 100 | 0 | BOŽANOVIĆ, Emilija ODŽK Beograd, Beograd | 0:59 |
| 3 - 4 | TOŠIĆ, Slađana Sveta Srbija, Beograd | 0 | 100 | DOMAZET, Tamara Partizan VML, Beograd | 1:59 |
| 1 - 5 | MIRKOV, Dunja Voždovac, Beograd | 100 | 0 | MARIĆ, Katarina Crvena Zvezda, Beograd | 1:59 |
| 2 - 3 | BOŽANOVIĆ, Emilija ODŽK Beograd, Beograd | 100 | 0 | TOŠIĆ, Slađana Sveta Srbija, Beograd | 2:02 |
| 4 - 5 | DOMAZET, Tamara Partizan VML, Beograd | 100 | 0 | MARIĆ, Katarina Crvena Zvezda, Beograd | 0:59 |
| 1 - 3 | MIRKOV, Dunja Voždovac, Beograd | 100 | 0 | TOŠIĆ, Slađana Sveta Srbija, Beograd | 0:43 |
| 2 - 4 | BOŽANOVIĆ, Emilija ODŽK Beograd, Beograd | 0 | 100 | DOMAZET, Tamara Partizan VML, Beograd | 3:40 |
| 3 - 5 | TOŠIĆ, Slađana Sveta Srbija, Beograd | 0 | 100 | MARIĆ, Katarina Crvena Zvezda, Beograd | 1:58 |
| 1 - 4 | MIRKOV, Dunja Voždovac, Beograd | 100 | 0 | DOMAZET, Tamara Partizan VML, Beograd | 0:56 |
| 2 - 5 | BOŽANOVIĆ, Emilija ODŽK Beograd, Beograd | 100 | 0 | MARIĆ, Katarina Crvena Zvezda, Beograd | 1:37 |

REZULTAT

| | |
|-----------------------|-----|
| 1. MIRKOV, Dunja | VOŽ |
| 2. DOMAZET, Tamara | VML |
| 3. BOŽANOVIĆ, Emilija | OJK |
| 3. MARIĆ, Katarina | CZB |
| 5. TOŠIĆ, Slađana | SVS |

Regionalni Šampionat BEOGRAD - KADETI 2019

Beograd, 09.02.2019 - Kadetkinje



-63kg

5 takmičarki

| | TAKMIČAR | POBEDNIČKI BODOVI | | | | | POBEDA | BODOVA | MESTO |
|---|--|-------------------|-----|-----|-----|---|--------|--------|-------|
| | | 1 | 2 | 3 | 4 | 5 | | | |
| 1 | DUGONJIĆ, Jana Partizan, Beograd | | 0 | 100 | 100 | 0 | 2 | 200 | 2 |
| 2 | ČAKAREVIĆ, Jovana Voždovac, Beograd | 10 | | 100 | 0 | 0 | 2 | 110 | 3 |
| 3 | ŽIVKOVIĆ, Irina Olimp, Beograd | 0 | 0 | | 0 | 0 | 0 | 0 | 5 |
| 4 | NEDELJKOVIĆ, Katarina Vinča, Beograd | 0 | 10 | 100 | | 0 | 2 | 110 | 3 |
| 5 | NIŠAVIĆ, Kristina Partizan VML, Beograd | 100 | 100 | 100 | 100 | | 4 | 400 | 1 |

Bodovi: Ippon 100 / Wazaari 10 / Kazna 0.5

Redosled borbi: 1 - 2, 3 - 4 / 1 - 5, 2 - 3 / 4 - 5, 1 - 3 / 2 - 4, 3 - 5 / 1 - 4, 2 - 5

| BORBE | TAKMIČAR | BODOVA | BODOVA | TAKMIČAR | VREME |
|-------|---|--------|--------|--|-------|
| 1 - 2 | DUGONJIĆ, Jana Partizan, Beograd | 0 | 10 | ČAKAREVIĆ, Jovana Voždovac, Beograd | 3:59 |
| 3 - 4 | ŽIVKOVIĆ, Irina Olimp, Beograd | 0 | 100 | NEDELJKOVIĆ, Katarina Vinča, Beograd | 1:48 |
| 1 - 5 | DUGONJIĆ, Jana Partizan, Beograd | 0 | 100 | NIŠAVIĆ, Kristina Partizan VML, Beograd | 2:33 |
| 2 - 3 | ČAKAREVIĆ, Jovana Voždovac, Beograd | 100 | 0 | ŽIVKOVIĆ, Irina Olimp, Beograd | 1:24 |
| 4 - 5 | NEDELJKOVIĆ, Katarina Vinča, Beograd | 0 | 100 | NIŠAVIĆ, Kristina Partizan VML, Beograd | 0:19 |
| 1 - 3 | DUGONJIĆ, Jana Partizan, Beograd | 100 | 0 | ŽIVKOVIĆ, Irina Olimp, Beograd | 2:19 |
| 2 - 4 | ČAKAREVIĆ, Jovana Voždovac, Beograd | 0 | 10 | NEDELJKOVIĆ, Katarina Vinča, Beograd | 3:59 |
| 3 - 5 | ŽIVKOVIĆ, Irina Olimp, Beograd | 0 | 100 | NIŠAVIĆ, Kristina Partizan VML, Beograd | 2:50 |
| 1 - 4 | DUGONJIĆ, Jana Partizan, Beograd | 100 | 0 | NEDELJKOVIĆ, Katarina Vinča, Beograd | 4:03 |
| 2 - 5 | ČAKAREVIĆ, Jovana Voždovac, Beograd | 0 | 100 | NIŠAVIĆ, Kristina Partizan VML, Beograd | 1:06 |

REZULTAT

| | |
|--------------------------|-----|
| 1. NIŠAVIĆ, Kristina | VML |
| 2. DUGONJIĆ, Jana | PBG |
| 3. ČAKAREVIĆ, Jovana | VOŽ |
| 3. NEDELJKOVIĆ, Katarina | VIN |
| 5. ŽIVKOVIĆ, Irina | OLI |

Regionalni Šampionat BEOGRAD - KADETI 2019

Beograd, 09.02.2019 - Kadetkinje

-70kg

1 takmičarka

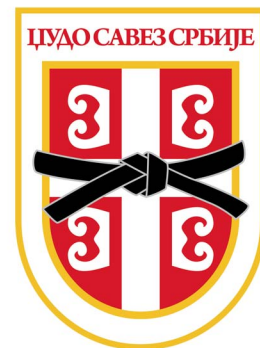

REZULTAT

1. POKRAJAC, Bojana MAK

Regionalni Šampionat BEOGRAD - KADETI 2019

Beograd, 09.02.2019 - Kadetkinje

+70kg

3 takmičarke



| | TAKMIČAR | POBEDNIČKI BODOVI | | | POBEDA | BODOVA | MESTO |
|----------|---|-------------------|-----|-----|--------|--------|-------|
| | | 1 | 2 | 3 | | | |
| 1 | MILANOVIĆ, Maša Knjaz Miloš, Beograd | | 100 | 0 | 1 | 100 | 2 |
| 2 | RUŽIČIĆ, Sara Crvena Zvezda, Beograd | 0 | | 100 | 1 | 100 | 3 |
| 3 | BOGDANOVIĆ, Anastasija Partizan VML, Beograd | 100 | 0 | | 1 | 100 | 1 |

BODOVI: Ippon 100 / Wazaari 10 / Kazna 0.5

Redosled borbi: 1 - 2 / 1 - 3 / 2 - 3

| BORBE | TAKMIČAR | BODOVA | BODOVA | TAKMIČAR | VREME |
|--------------|---|------------|------------|---|-------|
| 1 - 2 | MILANOVIĆ, Maša Knjaz Miloš, Beograd | 100 | 0 | RUŽIČIĆ, Sara Crvena Zvezda, Beograd | 2:18 |
| 1 - 3 | MILANOVIĆ, Maša Knjaz Miloš, Beograd | 0 | 100 | BOGDANOVIĆ, Anastasija Partizan VML, Beograd | 0:23 |
| 2 - 3 | RUŽIČIĆ, Sara Crvena Zvezda, Beograd | 100 | 0 | BOGDANOVIĆ, Anastasija Partizan VML, Beograd | 3:37 |

REZULTAT

1. BOGDANOVIĆ, Anastasija VML
2. MILANOVIĆ, Maša KNJ
3. RUŽIČIĆ, Sara CZB