

# Regionalni Šampionat VOJVODINA - KADETI 2018

Kač, 21.01.2018 - Kadeti



**-50kg**

13 takmičara

GRUPA A

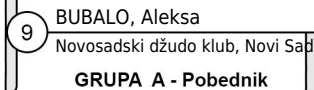
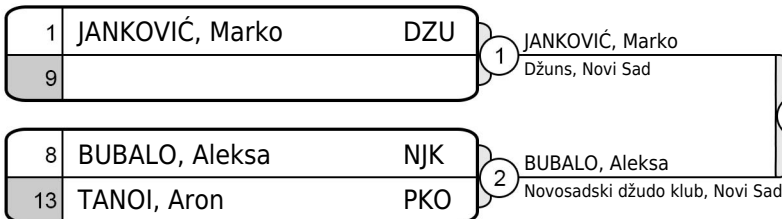

GRUPA B

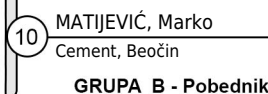
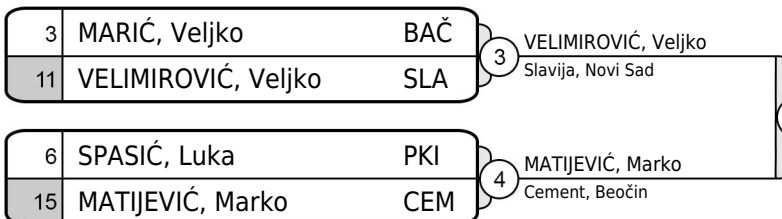

GRUPA C

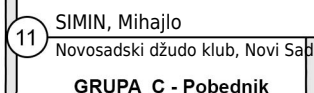
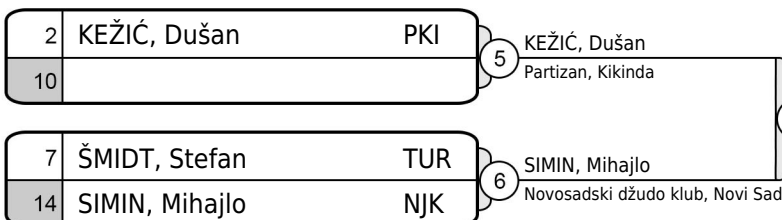

GRUPA D

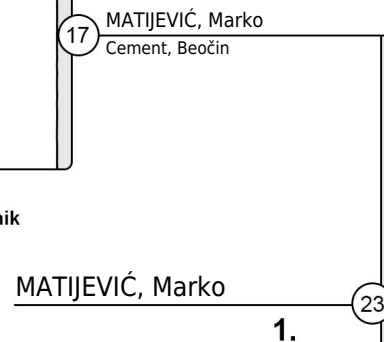
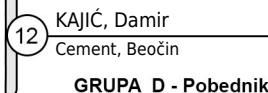
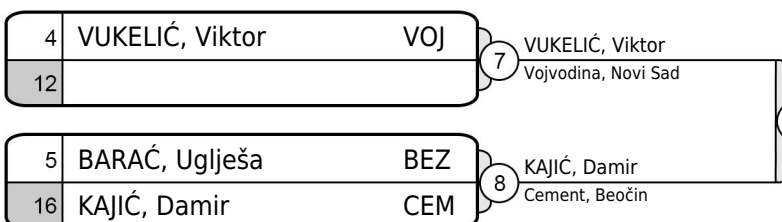

REZULTAT	
1.	MATIJEVIĆ, Marko CEM
2.	SIMIN, Mihajlo NJK
3.	VELIMIROVIĆ, Veljko SLA
4.	BUBALO, Aleksa NJK
5.	KAJIĆ, Damir CEM
6.	KEŽIĆ, Dušan PKI
7.	TANOI, Aron PKO
8.	BARAĆ, Uglješa BEZ

REPASAŽ

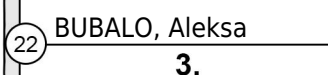
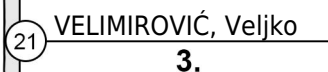
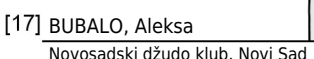
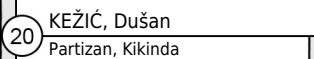
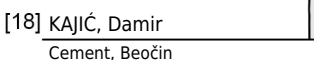
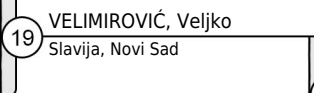

# Regionalni Šampionat VOJVODINA - KADETI 2018

Kač, 21.01.2018 - Kadeti



**-55kg**

8 takmičara

GRUPA A

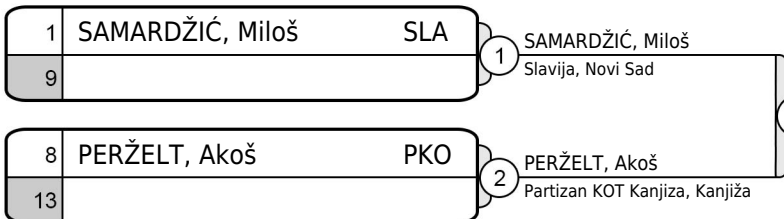

GRUPA B

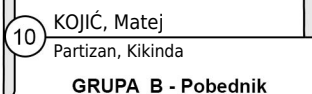
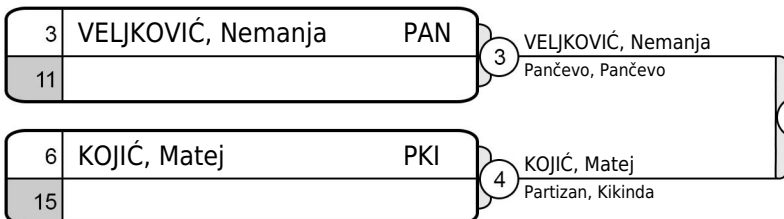

GRUPA C

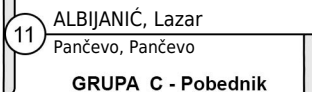
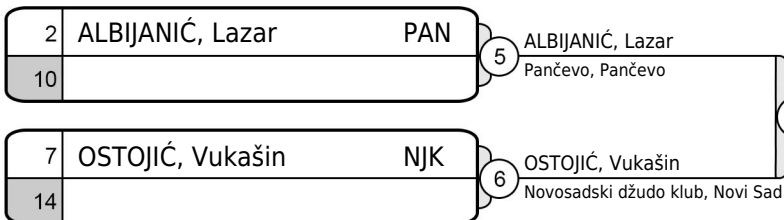

GRUPA D

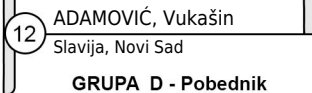
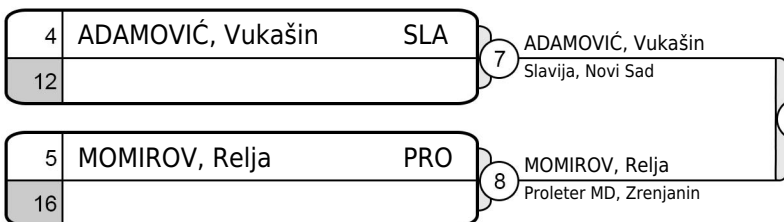

SAMARDŽIĆ, Miloš **1.**

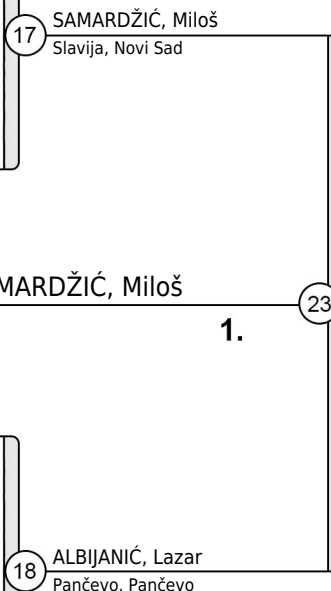

## REZULTAT

1.	SAMARDŽIĆ, Miloš	SLA
2.	ALBIJANIĆ, Lazar	PAN
3.	ADAMOVIĆ, Vukašin	SLA
4.	OSTOJIĆ, Vukašin	NJK
5.	PERŽELT, Akoš	PKO
6.	KOJIĆ, Matej	PKI
7.	VELJKOVIĆ, Nemanja	PAN
8.	MOMIROV, Relja	PRO

REPASAŽ

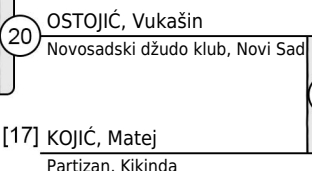
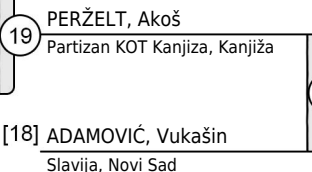
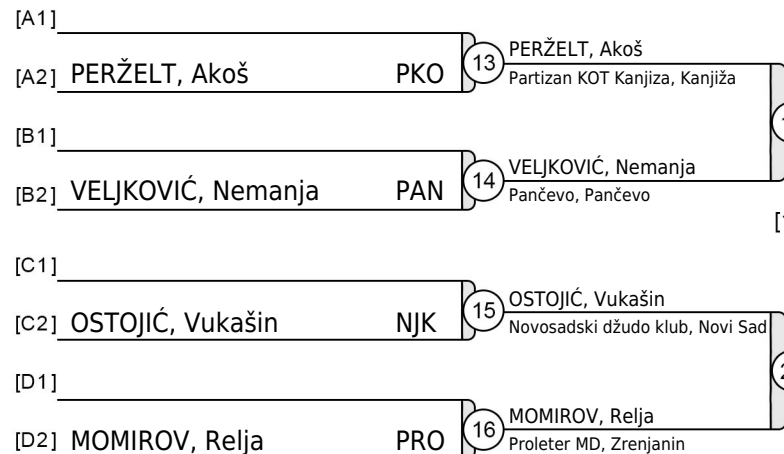

# Regionalni Šampionat VOJVODINA - KADETI 2018

Kač, 21.01.2018 - Kadeti



**-60kg**

9 takmičara

GRUPA A

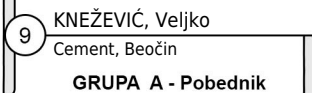
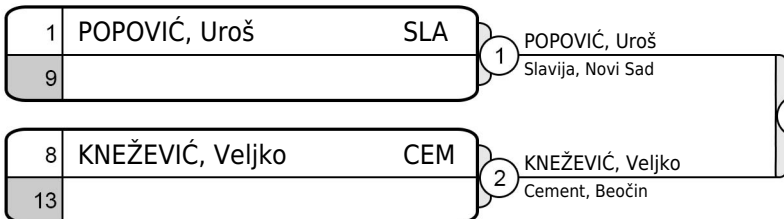

GRUPA B

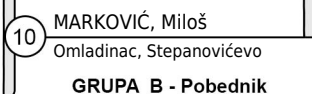
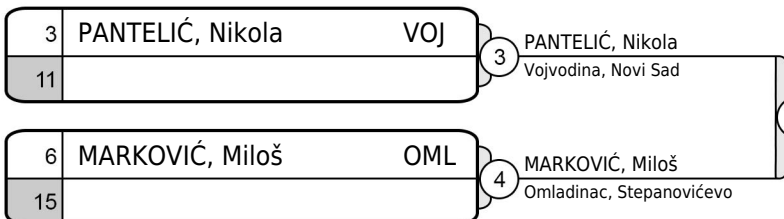

GRUPA C

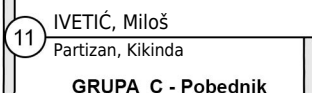
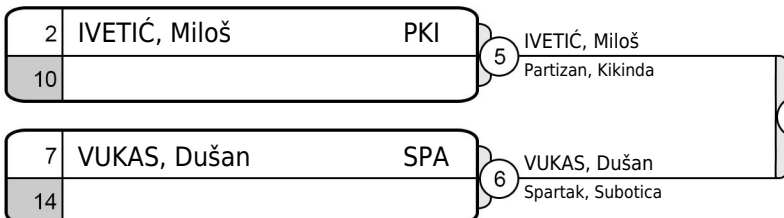

GRUPA D

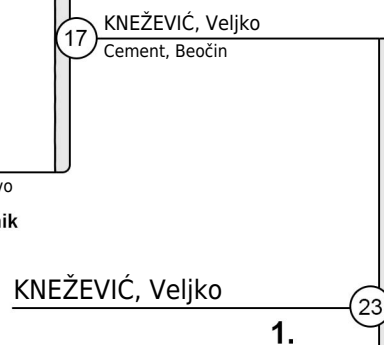
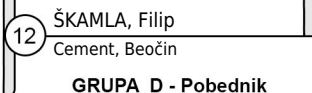
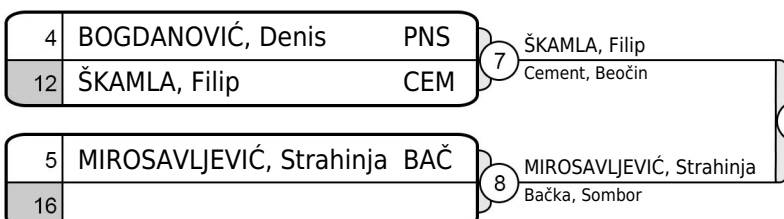

KNEŽEVIĆ, Veljko

1.

## REZULTAT

1.	KNEŽEVIĆ, Veljko	CEM
2.	ŠKAMLA, Filip	CEM
3.	IVETIĆ, Miloš	PKI
4.	BOGDANOVIĆ, Denis	PNS
5.	PANTELIĆ, Nikola	VOJ
6.	MARKOVIĆ, Miloš	OML
7.	POPOVIĆ, Uroš	SLA
8.	VUKAS, Dušan	SPA

REPASAŽ

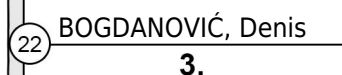
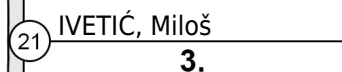
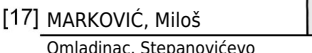
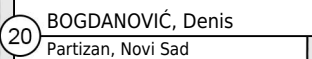
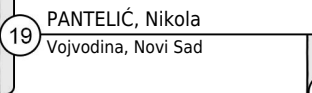
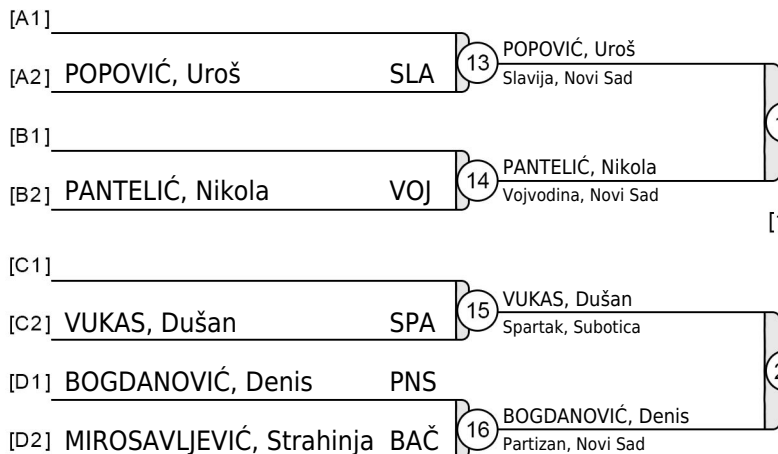

# Regionalni Šampionat VOJVODINA - KADETI 2018

Kač, 21.01.2018 - Kadeti



## -66kg

20 takmičara

GRUPA A

1	OTIĆ, Marko	SLA
17		
9	JEGDIĆ, Veljko	SPA
25	ARSIĆ, Željko	PNS
5	NIKOLIĆ, Nemanja	CEM
21		
13		
29	KOJČIĆ, Nemanja	PRO

1	OTIĆ, Marko	Slavija, Novi Sad
2	ARSIĆ, Željko	Partizan, Novi Sad
3	NIKOLIĆ, Nemanja	Cement, Beočin
4	KOJČIĆ, Nemanja	Proleter MD, Zrenjanin
17	OTIĆ, Marko	Slavija, Novi Sad
18	KOJČIĆ, Nemanja	Proleter MD, Zrenjanin
25	OTIĆ, Marko	Slavija, Novi Sad

**GRUPA A - Pobjednik**

GRUPA B

4	CVIJIĆ, Milan	SLA
20		
12	JEKIĆ, Nikola	PRO
28	KAJIĆ, Alen	CEM
8	TABANDŽELIĆ, Nikola	RUM
24		
16		
32	ARSIĆ, Živko	PNS

5	CVIJIĆ, Milan	Slavija, Novi Sad
6	KAJIĆ, Alen	Cement, Beočin
7	TABANDŽELIĆ, Nikola	Ruma, Ruma
8	ARSIĆ, Živko	Partizan, Novi Sad
19	CVIJIĆ, Milan	Slavija, Novi Sad
20	ARSIĆ, Živko	Partizan, Novi Sad
26	ARSIĆ, Živko	Partizan, Novi Sad

**GRUPA B - Pobjednik**

GRUPA C

2	MILEUSNIĆ, Luka	SLA
18		
10	MIKLOŠI, Danijel	PNS
26	KOSOVIC, Velimir	CEM
6	ŽIVKOV, Nemanja	MLA
22		
14		
30	KUKAVICA, Damir	YAM

9	MILEUSNIĆ, Luka	Slavija, Novi Sad
10	KOSOVIC, Velimir	Cement, Beočin
11	ŽIVKOV, Nemanja	Mladost, Bečej
12	KUKAVICA, Damir	Yamarashi, Temerin
21	KOSOVIC, Velimir	Cement, Beočin
22	KUKAVICA, Damir	Yamarashi, Temerin
27	KOSOVIC, Velimir	Cement, Beočin

**GRUPA C - Pobjednik**

GRUPA D

3	JOVIĆ, Stefan	BEZ
19		
11	MILOŠEV, Mihailo	SPA
27	MARČETIĆ, Miloš	RUM
7	PETKOVIĆ, Vuk	CEM
23		
15		
31	KATIĆ, Srđan	PNS

13	JOVIĆ, Stefan	Bezbednost, Novi Sad
14	MILOŠEV, Mihailo	Spartak, Subotica
15	PETKOVIĆ, Vuk	Cement, Beočin
16	KATIĆ, Srđan	Partizan, Novi Sad
23	JOVIĆ, Stefan	Bezbednost, Novi Sad
24	PETKOVIĆ, Vuk	Cement, Beočin
28	PETKOVIĆ, Vuk	Cement, Beočin

**GRUPA D - Pobjednik**

OTIĆ, Marko **1.**

REZULTAT	
1.	OTIĆ, Marko SLA
2.	KOSOVIC, Velimir CEM
3.	CVIJIĆ, Milan SLA
5.	MILEUSNIĆ, Luka SLA
5.	PETKOVIĆ, Vuk CEM
7.	ARSIĆ, Živko PNS
7.	KOJČIĆ, Nemanja PRO
7.	KATIĆ, Srđan PNS

REPASAŽ

[A1]			29	ARSIĆ, Željko
[A2]	ARSIĆ, Željko	PNS	33	KOJČIĆ, Nemanja
[B1]			30	TABANDŽELIĆ, Nikola
[B2]	TABANDŽELIĆ, Nikola	RUM	34	CVIJIĆ, Milan
[C1]	MIKLOŠI, Danijel	PNS	31	MILEUSNIĆ, Luka
[C2]	MILEUSNIĆ, Luka	SLA	35	MILEUSNIĆ, Luka
[D1]			32	KATIĆ, Srđan
[D2]	KATIĆ, Srđan	PNS	36	KATIĆ, Srđan
[D3]	JOVIĆ, Stefan			

39	CVIJIĆ, Milan
41	CVIJIĆ, Milan
38	PETKOVIĆ, Vuk
40	MILEUSNIĆ, Luka
42	MILEUSNIĆ, Luka
37	ARSIĆ, Živko

**3.**

**3.**

# Regionalni Šampionat VOJVODINA - KADETI 2018

Kač, 21.01.2018 - Kadeti



## -73kg

19 takmičara

GRUPA A

1	DESNICA, Strahinja	DZU
17		
9	KOŠIĆ, Vuk	DIN
25		
5	ZELIĆ, Bogdan	SLA
21		
13		
29	DEVIĆ, Slavko	NJK

1	DESNICA, Strahinja	Džuns, Novi Sad
2	KOŠIĆ, Vuk	Dinamo, Pančevo
3	ZELIĆ, Bogdan	Slavija, Novi Sad
4	DEVIĆ, Slavko	Novosadski džudo klub, Novi Sad

17	KOŠIĆ, Vuk	Dinamo, Pančevo
25	KOŠIĆ, Vuk	Dinamo, Pančevo
18	ZELIĆ, Bogdan	Slavija, Novi Sad
37	KOŠIĆ, Vuk	Dinamo, Pančevo

GRUPA A - Pobjednik

GRUPA B

4	VUKOBRATOVIĆ, Uglješa	BAČ
20		
12	JOVIČIĆ, Danilo	BIN
28	DOBANOVAČKI, Sava	VOJ
8	BLEŠIĆ, Nikola	PRO
24		
16		
32	SVONJA, Bogdan	VOJ

5	VUKOBRATOVIĆ, Uglješa	Bačka, Sombor
6	JOVIČIĆ, Danilo	Bezbednost, Inđija
7	BLEŠIĆ, Nikola	Proleter MD, Zrenjanin
8	SVONJA, Bogdan	Vojvodina, Novi Sad

19	VUKOBRATOVIĆ, Uglješa	Bačka, Sombor
20	SVONJA, Bogdan	Vojvodina, Novi Sad
26	VUKOBRATOVIĆ, Uglješa	Bačka, Sombor

GRUPA B - Pobjednik

GRUPA C

2	SANDIĆ, Radovan	PKI
18		
10	KOVČIN, Luka	NJK
26	ADAM, Danilo	TSK
6	ZUBOVIĆ, Stefan	SLR
22		
14		
30	SVONJA, Nikola	VOJ

9	SANDIĆ, Radovan	Partizan, Kikinda
10	ADAM, Danilo	TSK Temerin, Temerin
11	ZUBOVIĆ, Stefan	Sloven Ruma, Ruma
12	SVONJA, Nikola	Vojvodina, Novi Sad

21	ADAM, Danilo	TSK Temerin, Temerin
22	SVONJA, Nikola	Vojvodina, Novi Sad
27	ADAM, Danilo	TSK Temerin, Temerin

GRUPA C - Pobjednik

GRUPA D

3	BEKUT, Uroš	TOR
19		
11	OSTOJIĆ, Dušan	SLA
27	KNEŽEVIĆ, Uroš	BAČ
7	VUJANOVIĆ, Boško	BEZ
23		
15		
31	SUBAŠIĆ, Nemanja	PNS

13	BEKUT, Uroš	Tori, Vrbas
14	OSTOJIĆ, Dušan	Slavija, Novi Sad
15	VUJANOVIĆ, Boško	Bezbednost, Novi Sad
16	SUBAŠIĆ, Nemanja	Partizan, Novi Sad

23	OSTOJIĆ, Dušan	Slavija, Novi Sad
24	SUBAŠIĆ, Nemanja	Partizan, Novi Sad
28	OSTOJIĆ, Dušan	Slavija, Novi Sad

GRUPA D - Pobjednik

KOŠIĆ, Vuk  
**1.**

REZULTAT	
1.	KOŠIĆ, Vuk DIN
2.	ADAM, Danilo TSK
3.	OSTOJIĆ, Dušan SLA
3.	SUBAŠIĆ, Nemanja PNS
5.	ZELIĆ, Bogdan SLA
5.	VUKOBRATOVIĆ, Uglješa BAČ
7.	JOVIČIĆ, Danilo BIN
7.	SANDIĆ, Radovan PKI

REPASAŽ

[A1]		
[A2]	DESNICA, Strahinja	DZU
[B1]		
[B2]	JOVIČIĆ, Danilo	BIN
[C1]	KOVČIN, Luka	NJK
[C2]	SANDIĆ, Radovan	PKI
[D1]	KNEŽEVIĆ, Uroš	BAČ
[D2]	BEKUT, Uroš	TOR

29	DESNICA, Strahinja	
30	JOVIČIĆ, Danilo	
31	SANDIĆ, Radovan	
32	BEKUT, Uroš	

33	ZELIĆ, Bogdan	
34	JOVIČIĆ, Danilo	
35	SANDIĆ, Radovan	
36	SUBAŠIĆ, Nemanja	
39	ZELIĆ, Bogdan	
40	SUBAŠIĆ, Nemanja	
41	OSTOJIĆ, Dušan	
42	SUBAŠIĆ, Nemanja	
43	OSTOJIĆ, Dušan	
44	VUKOBRATOVIĆ, Uglješa	

**3.**

**3.**

# Regionalni Šampionat VOJVODINA - KADETI 2018

Kač, 21.01.2018 - Kadeti

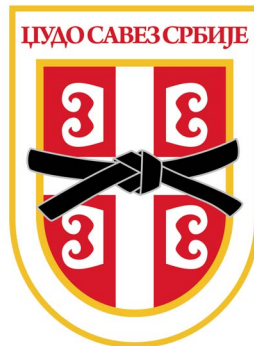

**-81kg**

13 takmičara

GRUPA A

1	SEKULOVIĆ, Miloš	DIN
9		
8	BOŠNJAK, Vuk	SPA
13	ŠAJIN, Sava	SIR

1	SEKULOVIĆ, Miloš	Dinamo, Pančevo
2	BOŠNJAK, Vuk	Spartak, Subotica

9	BOŠNJAK, Vuk	Spartak, Subotica
<b>GRUPA A - Pobjednik</b>		

GRUPA B

3	ERDELJAN, Miloš	DZU
11	ATARAC, Miroslav	
6	UŠLJEVRKA, Vladimir	SLR
15	LUDOŠKI, Dušan	PRO

3	ERDELJAN, Miloš	Džuns, Novi Sad
4	UŠLJEVRKA, Vladimir	Sloven Ruma, Ruma

10	UŠLJEVRKA, Vladimir	Sloven Ruma, Ruma
<b>GRUPA B - Pobjednik</b>		

GRUPA C

2	SABATUŠ, Danilo	OML
10		
7	BRDAR, Stefan	PNS
14	TUPEC, Mihajlo	SIR

5	SABATUŠ, Danilo	Omladinac, Stepanovićevo
6	BRDAR, Stefan	Partizan, Novi Sad

11	BRDAR, Stefan	Partizan, Novi Sad
<b>GRUPA C - Pobjednik</b>		

GRUPA D

4		
12	RATKOVIĆ, Filip	PAN
5	MARAVIĆ, Danijel	DIN
16	DELIĆ, Marko	PRO

7	RATKOVIĆ, Filip	Pančevo, Pančevo
8	MARAVIĆ, Danijel	Dinamo, Pančevo

12	MARAVIĆ, Danijel	Dinamo, Pančevo
<b>GRUPA D - Pobjednik</b>		

17	UŠLJEVRKA, Vladimir	Sloven Ruma, Ruma
23	UŠLJEVRKA, Vladimir	
<b>1.</b>		

REZULTAT		
1.	UŠLJEVRKA, Vladimir	SLR
2.	MARAVIĆ, Danijel	DIN
3.	LUDOŠKI, Dušan	PRO
4.	BOŠNJAK, Vuk	SPA
5.	BRDAR, Stefan	PNS
6.	TUPEC, Mihajlo	SIR
7.	DELIĆ, Marko	PRO

REPASAŽ

[A1] ŠAJIN, Sava SIR

[A2] SEKULOVIĆ, Miloš DIN

13	ŠAJIN, Sava	Sirmijum, Sremska Mitrovica
----	-------------	-----------------------------

[B1] LUDOŠKI, Dušan PRO

[B2] ERDELJAN, Miloš DZU

14	LUDOŠKI, Dušan	Proleter MD, Zrenjanin
----	----------------	------------------------

19	LUDOŠKI, Dušan	Proleter MD, Zrenjanin
----	----------------	------------------------

[18]	BRDAR, Stefan	Partizan, Novi Sad
------	---------------	--------------------

21	LUDOŠKI, Dušan	
<b>3.</b>		

[C1] TUPEC, Mihajlo SIR

[C2] SABATUŠ, Danilo OML

15	TUPEC, Mihajlo	Sirmijum, Sremska Mitrovica
----	----------------	-----------------------------

[D1] DELIĆ, Marko PRO

[D2] RATKOVIĆ, Filip PAN

16	DELIĆ, Marko	Proleter MD, Zrenjanin
----	--------------	------------------------

20	TUPEC, Mihajlo	Sirmijum, Sremska Mitrovica
----	----------------	-----------------------------

[17]	BOŠNJAK, Vuk	Spartak, Subotica
------	--------------	-------------------

22	BOŠNJAK, Vuk	
<b>3.</b>		

# Regionalni Šampionat VOJVODINA - KADETI 2018

Kač, 21.01.2018 - Kadeti



**-90kg**

10 takmičara

GRUPA A

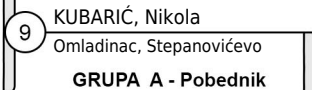
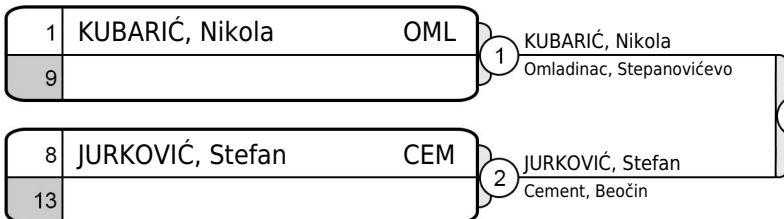

GRUPA B

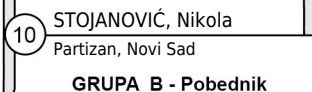
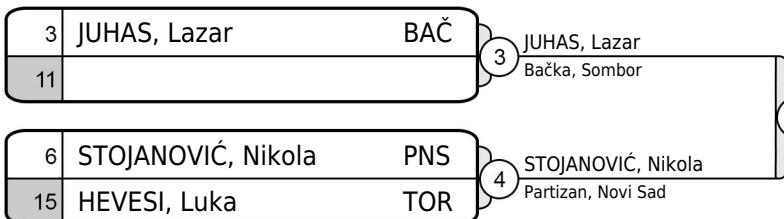

GRUPA C

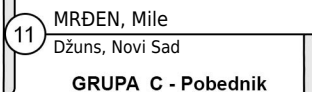
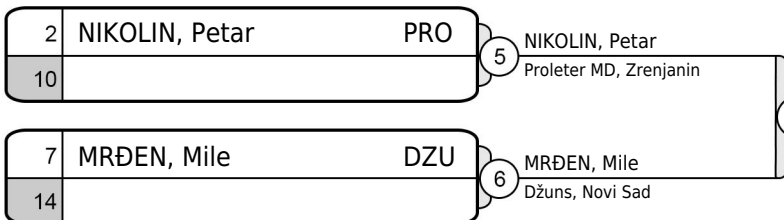

GRUPA D

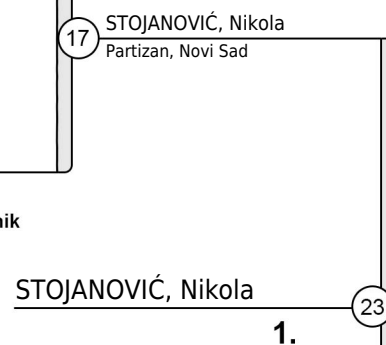
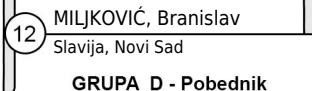
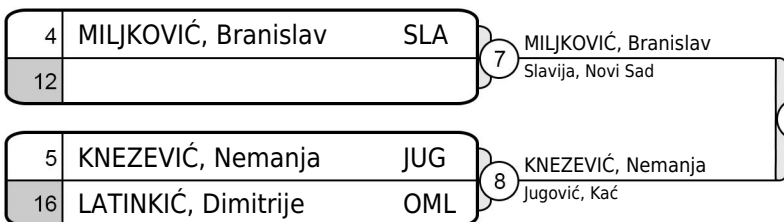

REZULTAT	
1.	STOJANOVIĆ, Nikola PNS
2.	MRĐEN, Mile DZU
3.	MILJKOVIĆ, Branislav SLA
3.	KUBARIĆ, Nikola OML
5.	HEVESI, Luka TOR
5.	NIKOLIN, Petar PRO
7.	JURKOVIĆ, Stefan CEM
7.	KNEZEVIĆ, Nemanja JUG

REPASAŽ

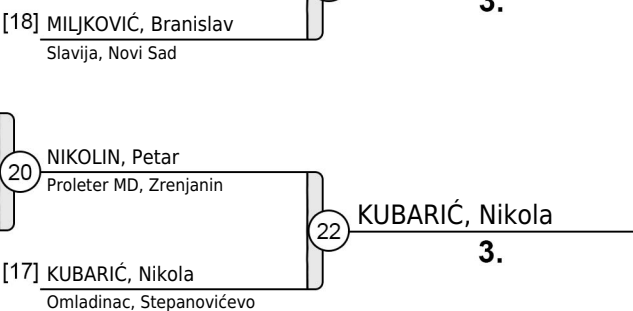
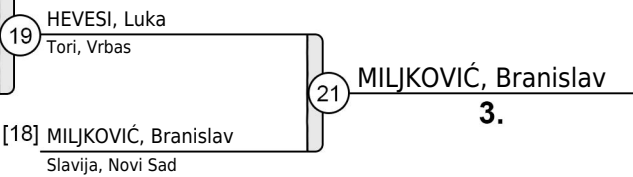
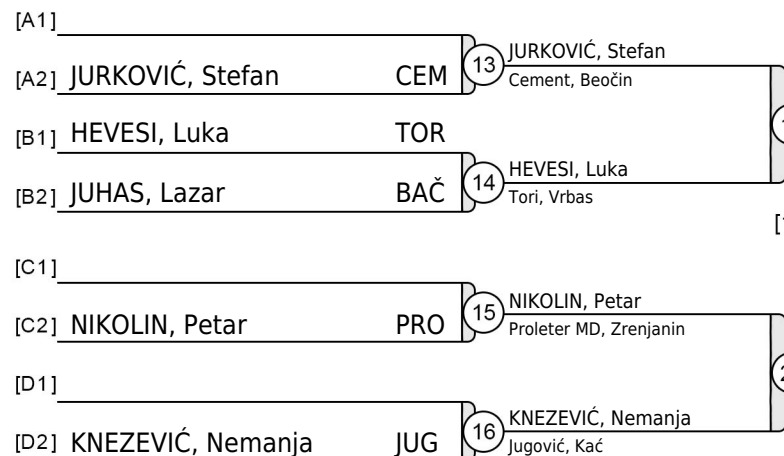

# Regionalni Šampionat VOJVODINA - KADETI 2018

Kać, 21.01.2018 - Kadeti



**+90kg**

6 takmičara

BORBE	TAKMIČAR	BODOVA	BODOVA	TAKMIČAR	VREME
1 - 2	VASIĆ, Marko Partizan, Novi Sad	0	10	STOJKOV, Aleksandar Mladost, Bečej	4:54
1 - 3	VASIĆ, Marko Partizan, Novi Sad	100	0	CRVENI, Đorđe Turija, Turija	0:49
2 - 3	STOJKOV, Aleksandar Mladost, Bečej	100	0	CRVENI, Đorđe Turija, Turija	0:12

[A1]	STOJKOV, Aleksandar	MLA	7	STOJKOV, Aleksandar	9
[B2]	INĐIĆ, Aleksa	DZU		Mladost, Bečej	
[B1]	BAKIĆ, Slobodan	PKI	8	BAKIĆ, Slobodan	9
[A2]	VASIĆ, Marko	PNS		Partizan, Kikinda	

BORBE	TAKMIČAR	BODOVA	BODOVA	TAKMIČAR	VREME
4 - 5	CRVENI, Branislav Turija, Turija	0	100	BAKIĆ, Slobodan Partizan, Kikinda	0:18
4 - 6	CRVENI, Branislav Turija, Turija	0	100	INĐIĆ, Aleksa Džuns, Novi Sad	0:34
5 - 6	BAKIĆ, Slobodan Partizan, Kikinda	100	0	INĐIĆ, Aleksa Džuns, Novi Sad	3:17

**BODOVI:** Ippon 100 / Wazaari 10 / Kazna 0.5

**Redosled borbi:** 1 - 2 / 4 - 5 / 1 - 3 / 4 - 6 / 2 - 3 / 5 - 6

## REZULTAT

1.	STOJKOV, Aleksandar	MLA
2.	BAKIĆ, Slobodan	PKI
3.	INĐIĆ, Aleksa	DZU
3.	VASIĆ, Marko	PNS
5.	CRVENI, Đorđe	TUR
5.	CRVENI, Branislav	TUR



# Regionalni Šampionat VOJVODINA - KADETI 2018

Kač, 21.01.2018 - Kadetkinje

**-40kg**

1 takmičarka



## REZULTAT

1. GERMANAC, Andela CEM

# Regionalni Šampionat VOJVODINA - KADETI 2018

Kač, 21.01.2018 - Kadetkinje



**-44kg**  
0 takmičarki

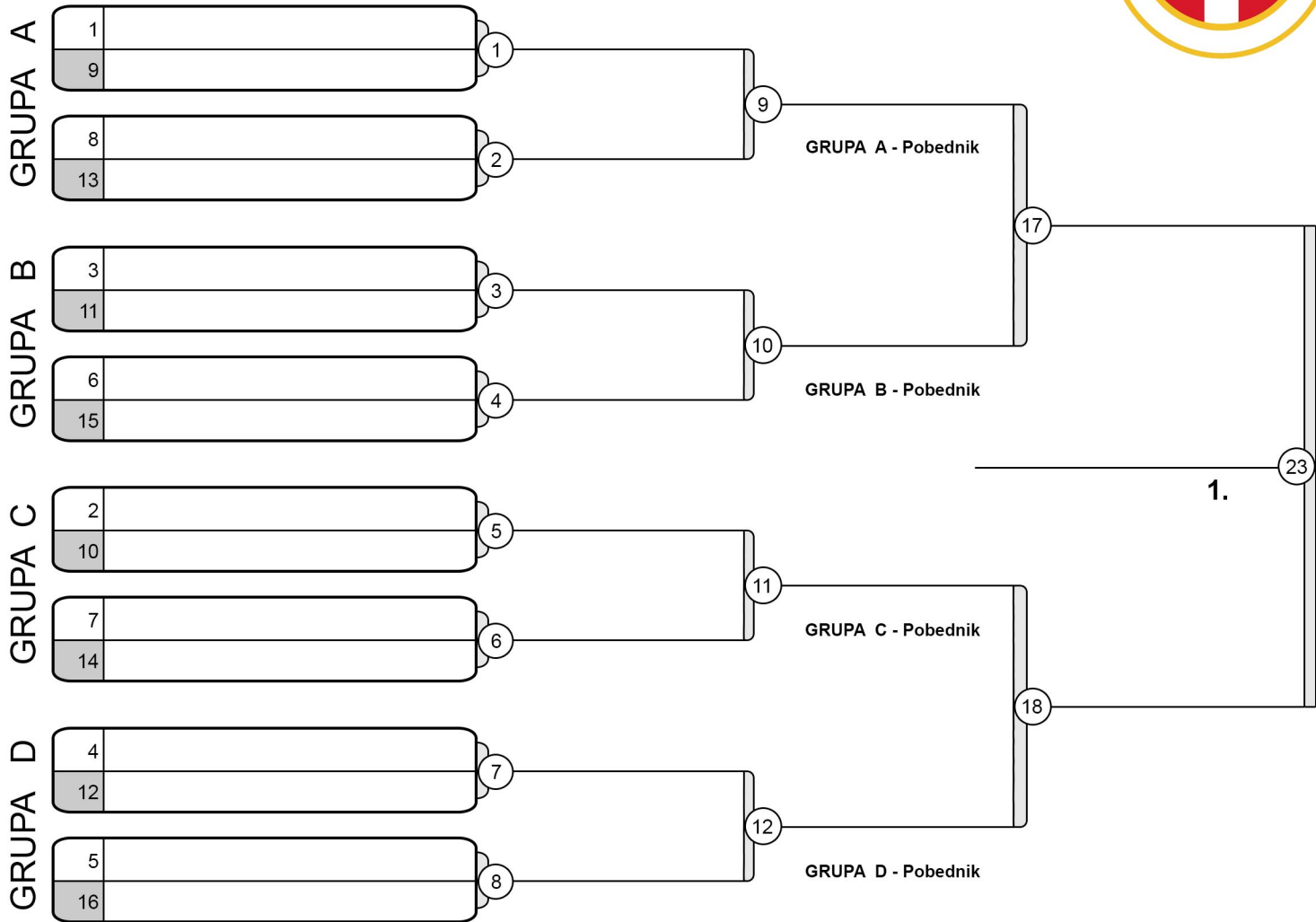

**REZULTAT**

- 1.
- 2.
- 3.
- 3.
- 5.
- 7.
- 7.

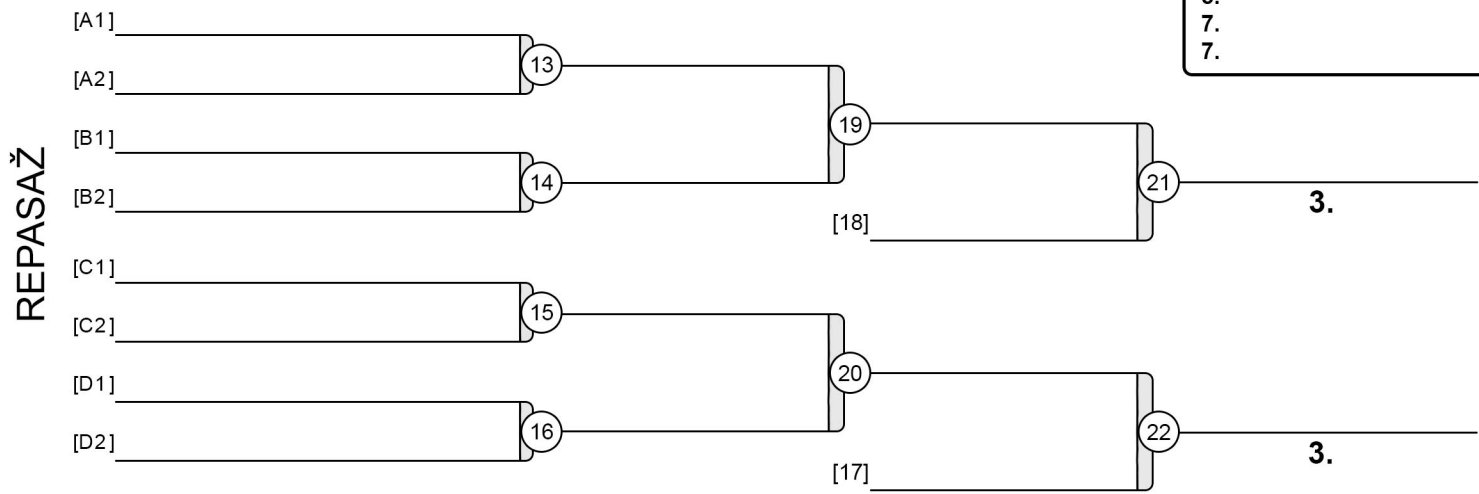

# Regionalni Šampionat VOJVODINA - KADETI 2018

Kač, 21.01.2018 - Kadetkinje



**-48kg**

6 takmičarki

BORBE	TAKMIČAR	BODOVA	BODOVA	TAKMIČAR	VREME
1 - 2	MILIĆ, Nevena Partizan, Kikinda	<b>100</b>	<b>0</b>	MILOŠEV, Jovana Pančevo, Pančevo	1:24
1 - 3	MILIĆ, Nevena Partizan, Kikinda	<b>100</b>	<b>0</b>	LAUŠ, Teodora Spartak, Subotica	0:31
2 - 3	MILOŠEV, Jovana Pančevo, Pančevo	<b>100</b>	<b>0</b>	LAUŠ, Teodora Spartak, Subotica	0:00



BORBE	TAKMIČAR	BODOVA	BODOVA	TAKMIČAR	VREME
4 - 5	MLADENOVIĆ, Anđela Slavija, Novi Sad	<b>100</b>	<b>0</b>	KOJIĆ, Tara Partizan, Kikinda	1:09
4 - 6	MLADENOVIĆ, Anđela Slavija, Novi Sad	<b>100</b>	<b>0</b>	KENYERES, Jazmin Partizan KOT Kanjiza, Kanjiža	0:26
5 - 6	KOJIĆ, Tara Partizan, Kikinda	<b>100</b>	<b>0</b>	KENYERES, Jazmin Partizan KOT Kanjiza, Kanjiža	1:15

**BODOVI:** Ippon 100 / Wazaari 10 / Kazna 0.5

**Redosled borbi:** 1 - 2 / 4 - 5 / 1 - 3 / 4 - 6 / 2 - 3 / 5 - 6

## REZULTAT

- |    |                    |     |
|----|--------------------|-----|
| 1. | MILIĆ, Nevena      | PKI |
| 2. | MLADENOVIĆ, Anđela | SLA |
| 3. | KOJIĆ, Tara        | PKI |
| 3. | MILOŠEV, Jovana    | PAN |
| 5. | LAUŠ, Teodora      | SPA |
| 5. | KENYERES, Jazmin   | PKO |

# Regionalni Šampionat VOJVODINA - KADETI 2018

Kač, 21.01.2018 - Kadetkinje

**-52kg**

3 takmičarke

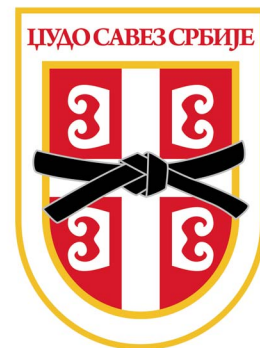

	TAKMIČAR	POBEDNIČKI BODOVI			POBEDA	BODOVA	MESTO
		1	2	3			
<b>1</b>	MRDALJ, Lana TSK Temerin, Temerin		100	100	2	200	1
<b>2</b>	BJELIĆ, Branislava Sloven Ruma, Ruma	0		100	1	100	2
<b>3</b>	KOZIĆ, Mina Partizan, Kikinda	0	0		0	0	3

**BODOVI:** Ippon 100 / Wazaari 10 / Kazna 0.5

**Redosled borbi:** 1 - 2 / 1 - 3 / 2 - 3

BORBE	TAKMIČAR	BODOVA	BODOVA	TAKMIČAR	VREME
1 - 2	MRDALJ, Lana TSK Temerin, Temerin	<b>100</b>	<b>0</b>	BJELIĆ, Branislava Sloven Ruma, Ruma	1:56
1 - 3	MRDALJ, Lana TSK Temerin, Temerin	<b>100</b>	<b>0</b>	KOZIĆ, Mina Partizan, Kikinda	2:51
2 - 3	BJELIĆ, Branislava Sloven Ruma, Ruma	<b>100</b>	<b>0</b>	KOZIĆ, Mina Partizan, Kikinda	0:58

## REZULTAT

1. MRDALJ, Lana TSK  
2. BJELIĆ, Branislava SLR  
3. KOZIĆ, Mina PKI

# Regionalni Šampionat VOJVODINA - KADETI 2018

Kač, 21.01.2018 - Kadetkinje



**-57kg**

7 takmičarki

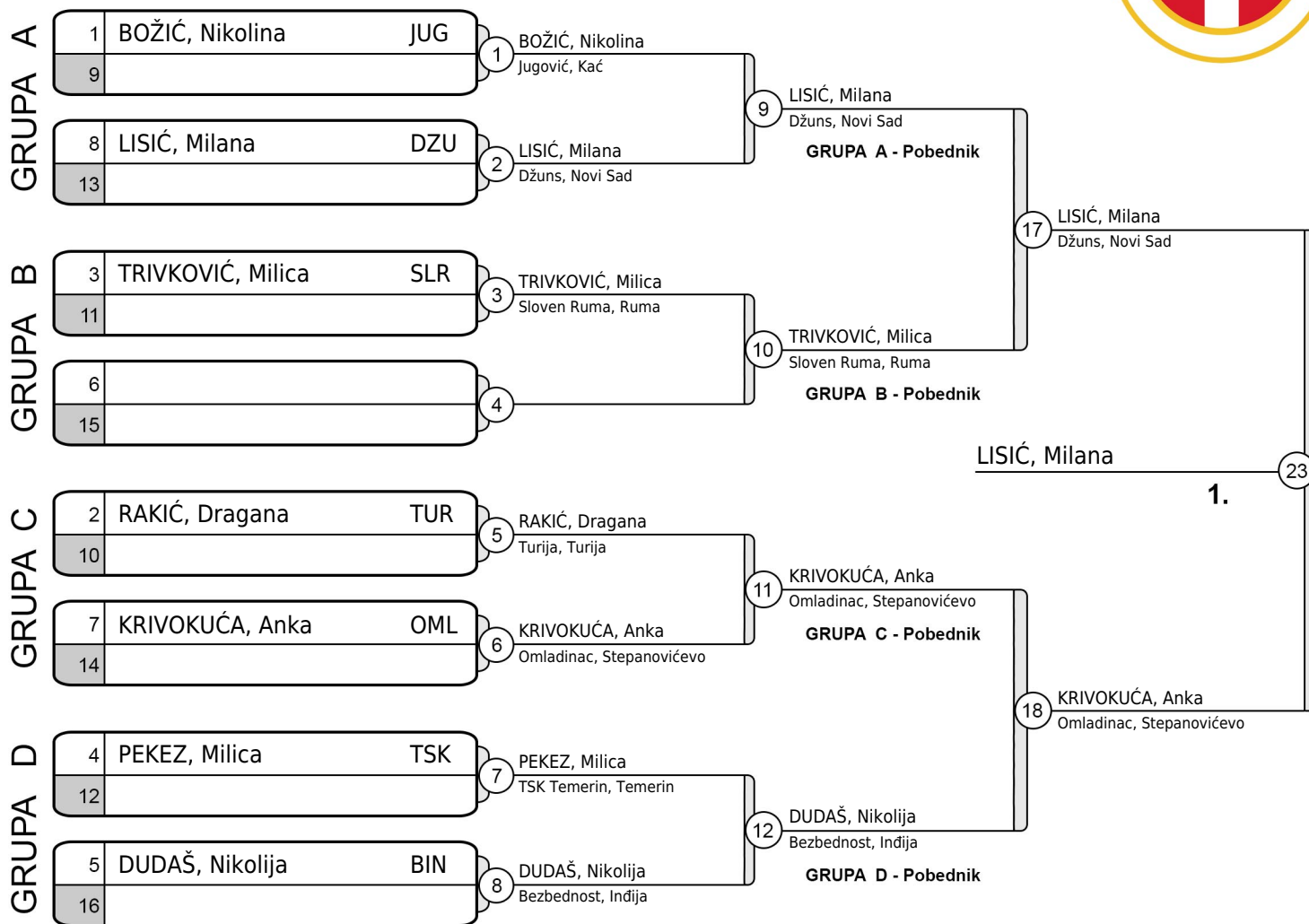

## REZULTAT

- |    |                   |     |
|----|-------------------|-----|
| 1. | LISIĆ, Milana     | DZU |
| 2. | KRIVOKUĆA, Anka   | OML |
| 3. | DUDAŠ, Nikolija   | BIN |
| 3. | TRIVKOVIĆ, Milica | SLR |
| 5. | BOŽIĆ, Nikolina   | JUG |
| 5. | RAKIĆ, Dragana    | TUR |
| 7. |                   |     |
| 7. | PEKEZ, Milica     | TSK |

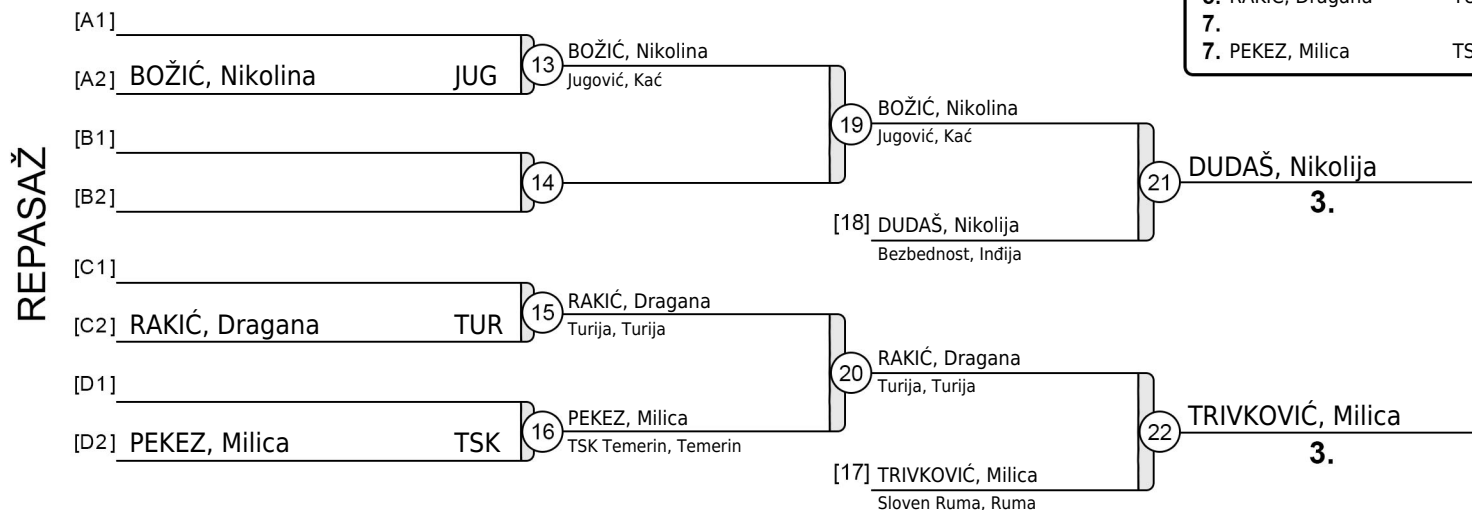

# Regionalni Šampionat VOJVODINA - KADETI 2018

Kač, 21.01.2018 - Kadetkinje



**-63kg**

8 takmičarki

GRUPA A

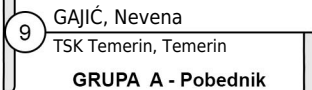
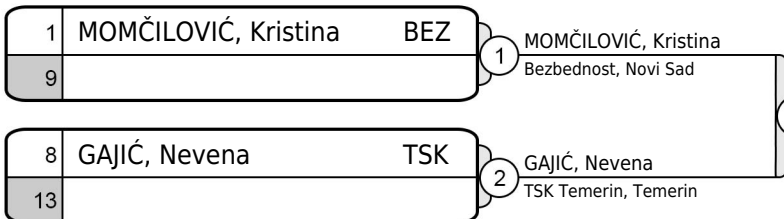

GRUPA B

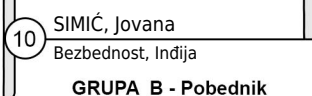
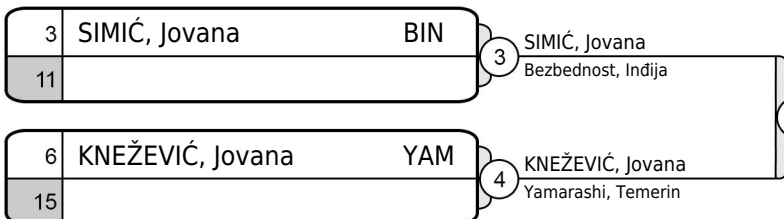

GRUPA C

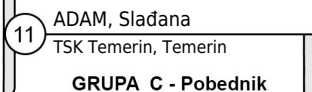
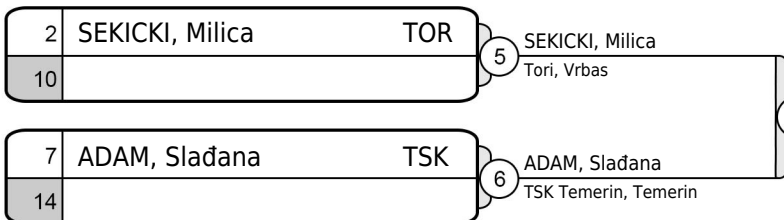

GRUPA D

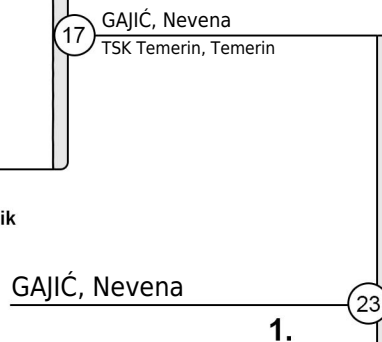
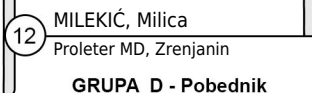
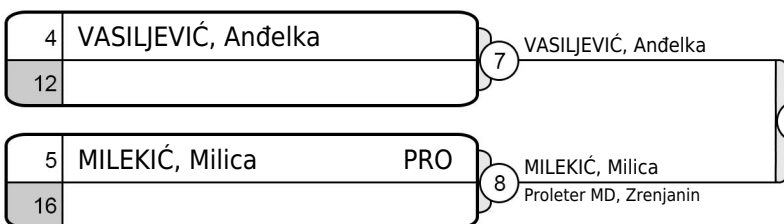

GAJIĆ, Nevena

1.

## REZULTAT

1. GAJIĆ, Nevena TSK
2. ADAM, Slađana TSK
3. MOMČILOVIĆ, Kristina BEZ
3. SIMIĆ, Jovana BIN
5. MILEKIĆ, Milica PRO
5. SEKICKI, Milica TOR
7. KNEŽEVIĆ, Jovana YAM
- 7.

REPASAŽ

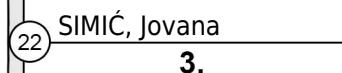
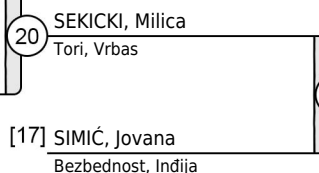
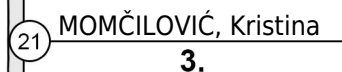
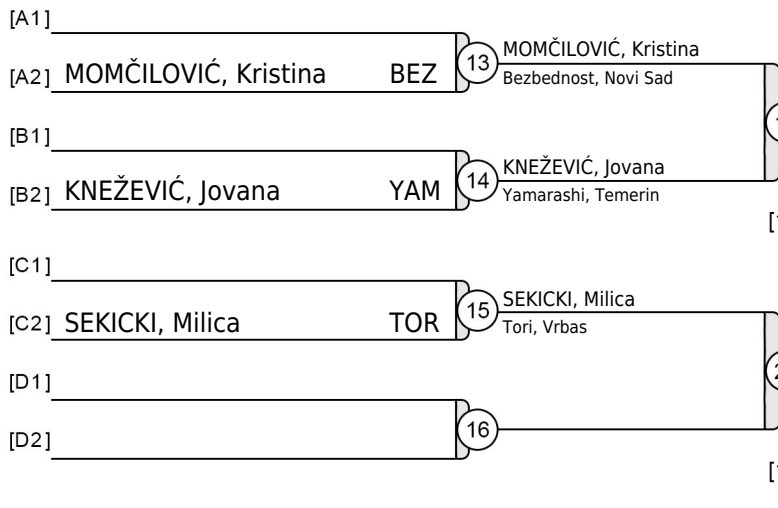

# Regionalni Šampionat VOJVODINA - KADETI 2018

Kač, 21.01.2018 - Kadetkinje



**-70kg**

8 takmičarki

GRUPA A

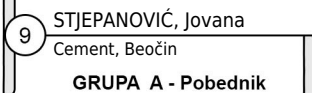
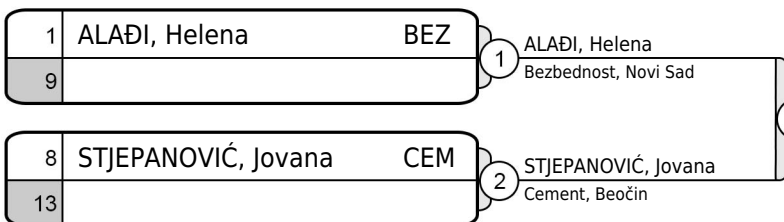

GRUPA B

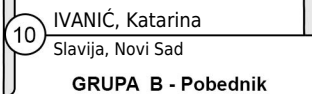
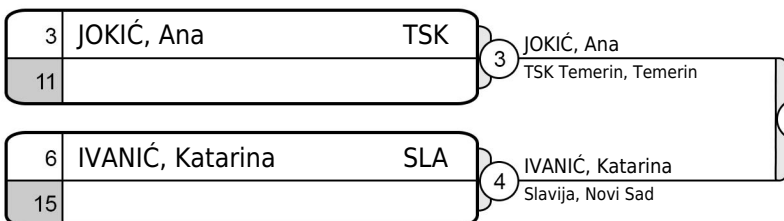

GRUPA C

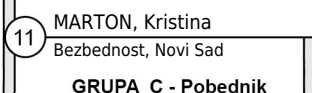
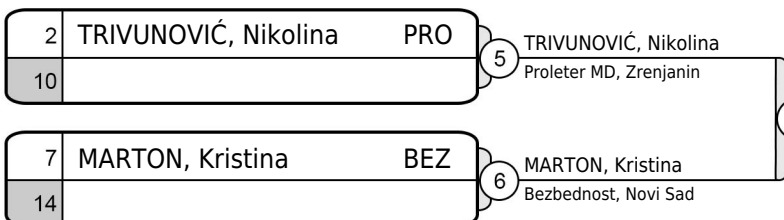

GRUPA D

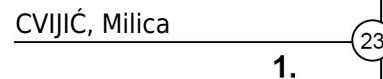
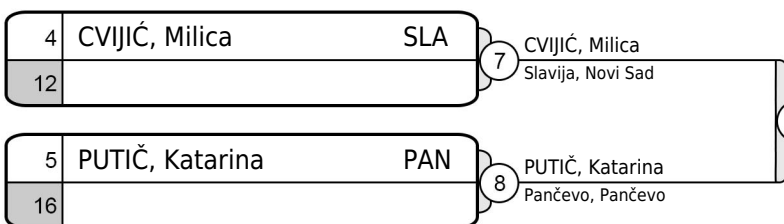

REZULTAT	
1.	CVIJIĆ, Milica SLA
2.	IVANIĆ, Katarina SLA
3.	JOKIĆ, Ana TSK
4.	STJEPANOVIĆ, Jovana CEM
5.	MARTON, Kristina BEZ
6.	PUTIČ, Katarina PAN
7.	ALADI, Helena BEZ
8.	TRIVUNOVIĆ, Nikolina PRO

REPASAŽ

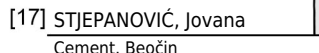
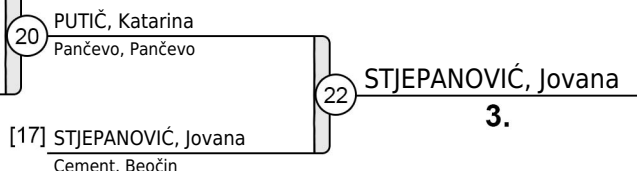
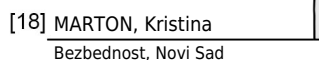
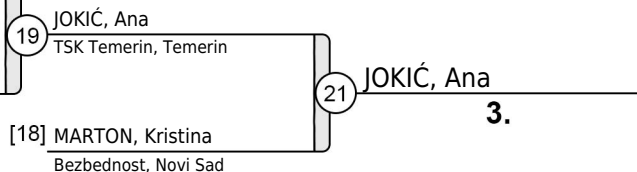
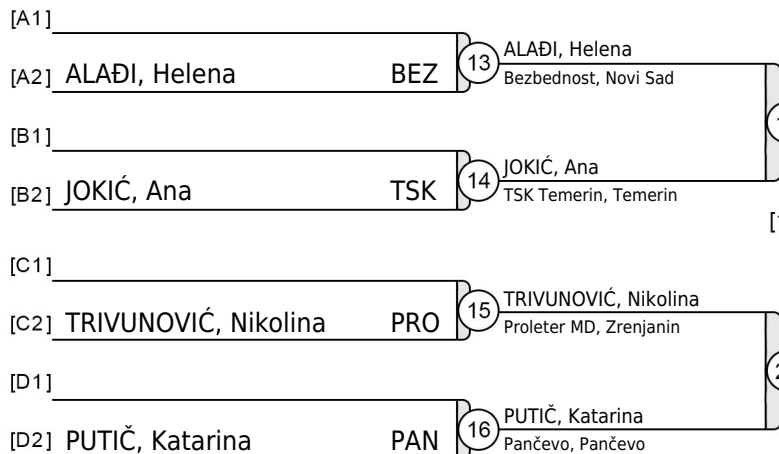

# Regionalni Šampionat VOJVODINA - KADETI 2018

Kač, 21.01.2018 - Kadetkinje



**+70kg**

6 takmičarki

BORBE	TAKMIČAR	BODOVA	BODOVA	TAKMIČAR	VREME
1 - 2	ORLOVIĆ, Katarina Ruma, Ruma	<b>100</b>	<b>0</b>	SIKIMA, Jana Bačka, Sombor	1:53
1 - 3	ORLOVIĆ, Katarina Ruma, Ruma	<b>100</b>	<b>0</b>	GORDIĆ, Ivana Omladinac, Stepanovićevo	2:43
2 - 3	SIKIMA, Jana Bačka, Sombor	<b>0</b>	<b>100</b>	GORDIĆ, Ivana Omladinac, Stepanovićevo	3:01

[A1] ORLOVIĆ, Katarina	RUM	7	ORLOVIĆ, Katarina Ruma, Ruma
[B2] NEŠKOVIĆ, Milica	BEZ		
[B1] JURKOVIĆ, Gordana	CEM	8	GORDIĆ, Ivana Omladinac, Stepanovićevo
[A2] GORDIĆ, Ivana	OML		
		9	ORLOVIĆ, Katarina Ruma, Ruma

BORBE	TAKMIČAR	BODOVA	BODOVA	TAKMIČAR	VREME
4 - 5	JURKOVIĆ, Gordana Cement, Beočin	<b>100</b>	<b>0</b>	NEŠKOVIĆ, Milica Bezbednost, Novi Sad	1:47
4 - 6	JURKOVIĆ, Gordana Cement, Beočin	<b>100</b>	<b>0</b>	BOŠNJAK, Gordana Proleter MD, Zrenjanin	1:11
5 - 6	NEŠKOVIĆ, Milica Bezbednost, Novi Sad	<b>100</b>	<b>0</b>	BOŠNJAK, Gordana Proleter MD, Zrenjanin	0:53

**BODOVI:** Ippon 100 / Wazaari 10 / Kazna 0.5

**Redosled borbi:** 1 - 2 / 4 - 5 / 1 - 3 / 4 - 6 / 2 - 3 / 5 - 6

## REZULTAT

1. ORLOVIĆ, Katarina	RUM
2. GORDIĆ, Ivana	OML
3. NEŠKOVIĆ, Milica	BEZ
3. JURKOVIĆ, Gordana	CEM
5. SIKIMA, Jana	BAČ
5. BOŠNJAK, Gordana	PRO