



# REGIONALNO VOJVODINA S.DEČACI

Novi Sad, 15.05.2021.

STARIJI DEČACI

## -34KG

4 takmičara

TAKMIČAR I KLUB	1	2	3	4	POBEDA	BODOVA	MESTO
1 STOKANOVIĆ, Vukan Spartak, Subotica		0	0	0	0	0	3
2 STOJIC, Petar Dinamo, Pančevo	10		0	0	1	10	3
3 KESANSKI, Nemanja Džuns, Novi Sad	10	10		10	3	30	1
4 MARKOVIĆ, Mateja Kanjiža, Kanjiža	10	10	0		2	20	2

STOKANOVIĆ, Vukan	SPA	1	STOJIC, Petar
STOJIC, Petar	DIN		Dinamo, Pančevo
KESANSKI, Nemanja	DZU	2	KESANSKI, Nemanja
MARKOVIĆ, Mateja	KNJ		Džuns, Novi Sad
STOKANOVIĆ, Vukan	SPA	3	KESANSKI, Nemanja
KESANSKI, Nemanja	DZU		Džuns, Novi Sad
STOJIC, Petar	DIN	4	MARKOVIĆ, Mateja
MARKOVIĆ, Mateja	KNJ		Kanjiža, Kanjiža
STOKANOVIĆ, Vukan	SPA	5	MARKOVIĆ, Mateja
MARKOVIĆ, Mateja	KNJ		Kanjiža, Kanjiža
STOJIC, Petar	DIN	6	KESANSKI, Nemanja
KESANSKI, Nemanja	DZU		Džuns, Novi Sad

### Rezultati

1. KESANSKI, Nemanja DZU
2. MARKOVIĆ, Mateja KNJ
3. STOJIC, Petar DIN
3. STOKANOVIĆ, Vukan SPA



# REGIONALNO VOJVODINA S.DEČACI

Novi Sad, 15.05.2021.

STARIJI DEČACI

# -38KG

4 takmičara

TAKMIČAR I KLUB	1	2	3	4	POBEDA	BODOVA	MESTO
1 KONDIĆ, Dante ODŽK Proleter MD, Zrenjanin		0	0	0	0	0	3
2 ĆIRIĆ, Filip Dinamo, Pančevo	10		10	0	2	20	2
3 BIROVLJEV, Strahinja LSK Lačarak, Lačarak	10	0		0	1	10	3
4 NOVAKOVIĆ, Dejan Bačka, Sombor	10	10	1		3	21	1

KONDIĆ, Dante	PRO	1	ĆIRIĆ, Filip
ĆIRIĆ, Filip	DIN		Dinamo, Pančevo
BIROVLJEV, Strahinja	LAČ	2	NOVAKOVIĆ, Dejan
NOVAKOVIĆ, Dejan	BAČ		Bačka, Sombor
KONDIĆ, Dante	PRO	3	BIROVLJEV, Strahinja
BIROVLJEV, Strahinja	LAČ		LSK Lačarak, Lačarak
ĆIRIĆ, Filip	DIN	4	NOVAKOVIĆ, Dejan
NOVAKOVIĆ, Dejan	BAČ		Bačka, Sombor
KONDIĆ, Dante	PRO	5	NOVAKOVIĆ, Dejan
NOVAKOVIĆ, Dejan	BAČ		Bačka, Sombor
ĆIRIĆ, Filip	DIN	6	ĆIRIĆ, Filip
BIROVLJEV, Strahinja	LAČ		Dinamo, Pančevo

## Rezultati

1. NOVAKOVIĆ, Dejan BAČ
2. ĆIRIĆ, Filip DIN
3. BIROVLJEV, Strahinja LAČ
3. KONDIĆ, Dante PRO



# REGIONALNO VOJVODINA S.DEČACI

Novi Sad, 15.05.2021.

STARIJI DEČACI

# -42KG

12 takmičara

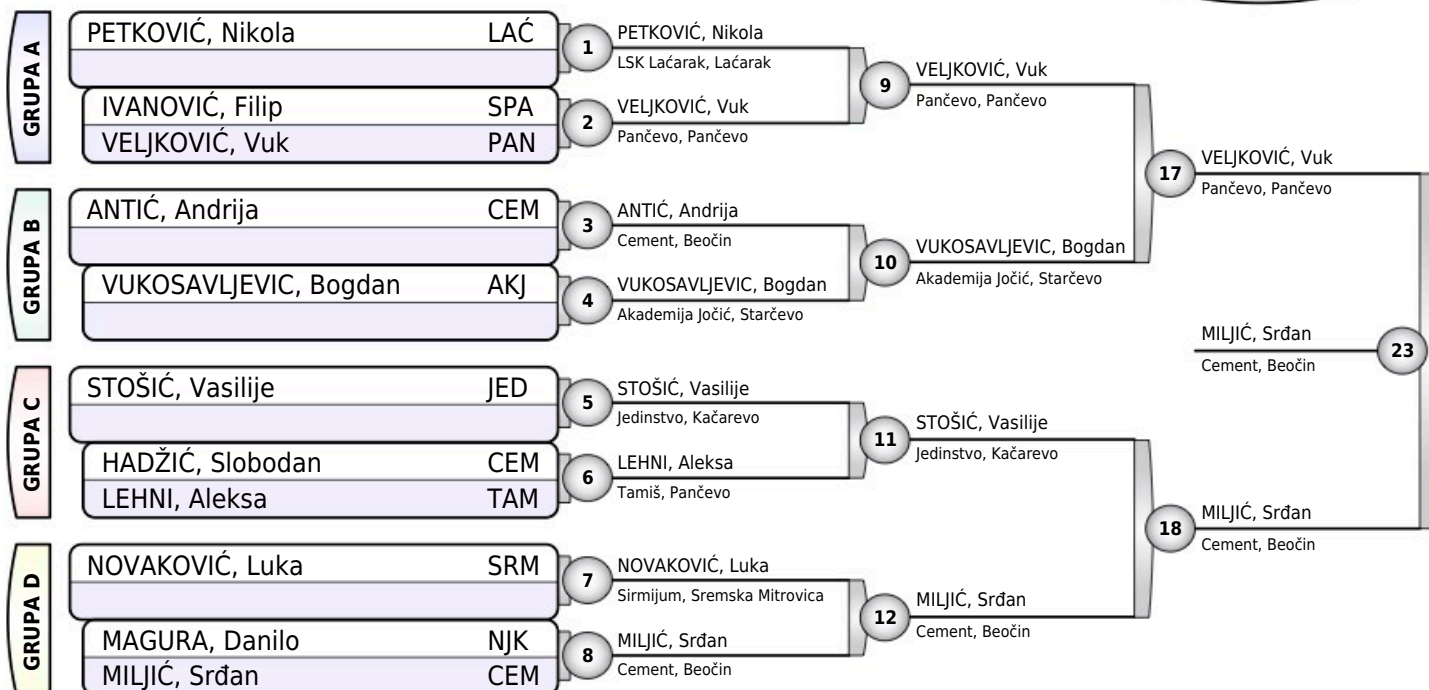

## Rezultati

1. MILJIĆ, Srđan CEM
2. VELJKOVIĆ, Vuk PAN
3. IVANOVIĆ, Filip SPA
3. MAGURA, Danilo NJK
5. STOŠIĆ, Vasilije JED
5. VUKOSAVLJEVIC, Bogdan AKJ
7. ANTIĆ, Andrija CEM
7. LEHNI, Aleksa TAM

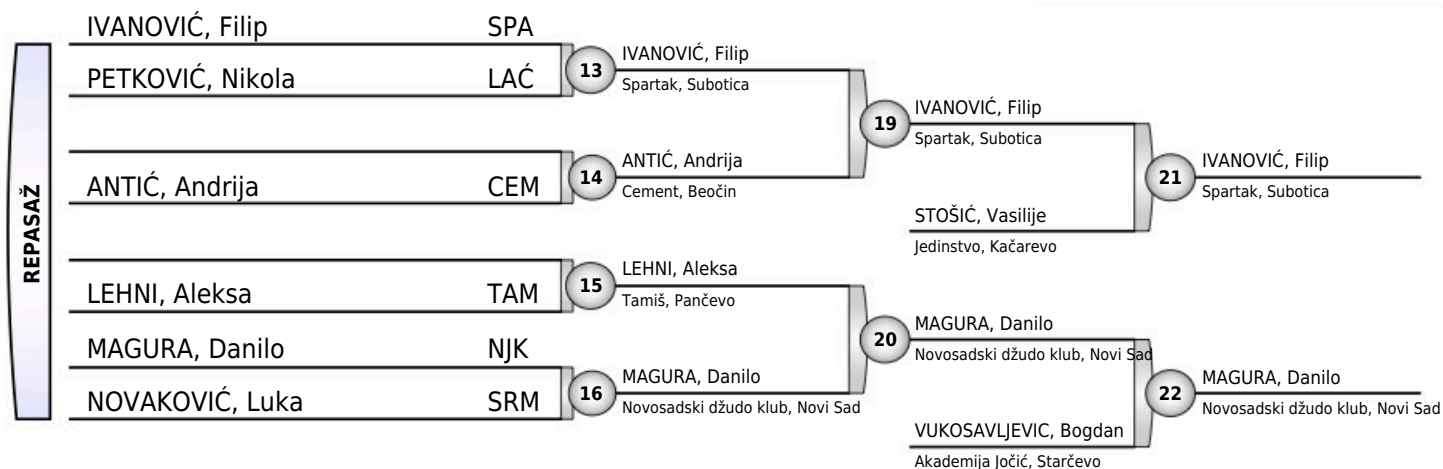



# REGIONALNO VOJVODINA S.DEČACI

Novi Sad, 15.05.2021.

STARIJI DEČACI

# -46KG

12 takmičara

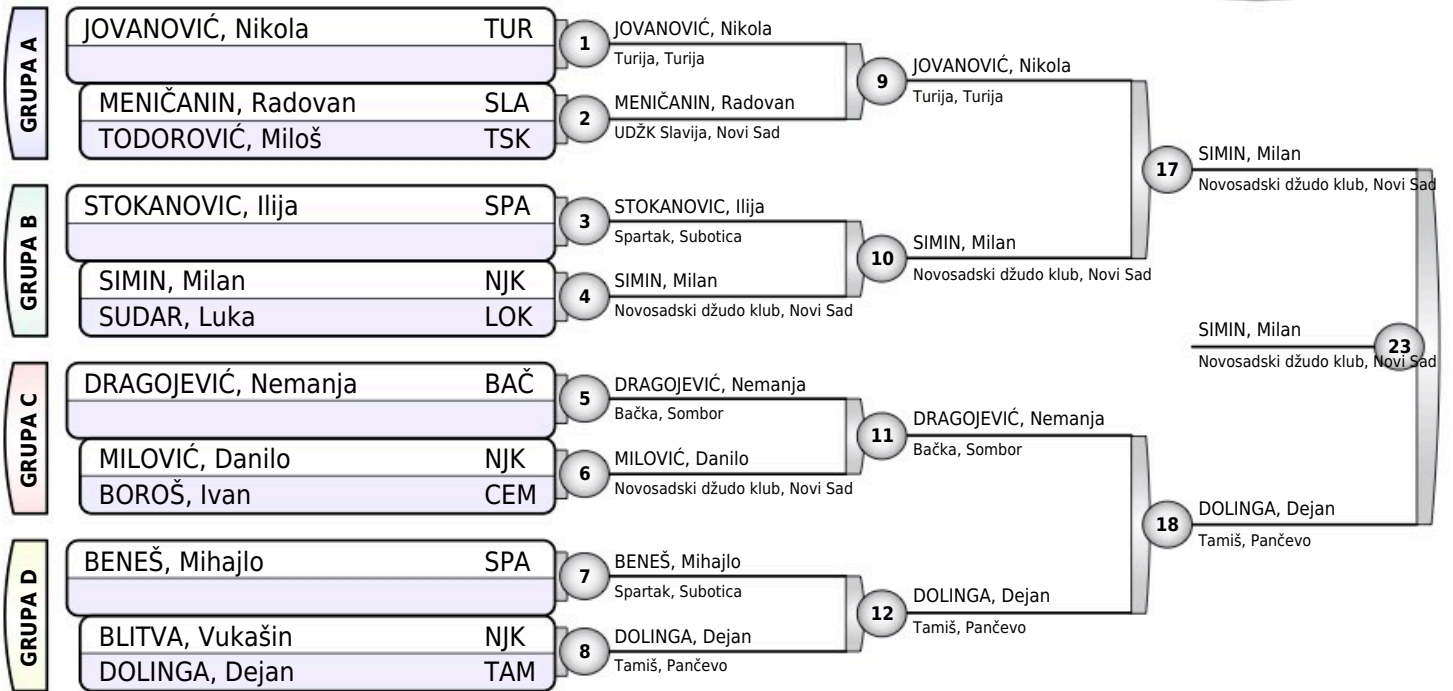

## Rezultati

1. SIMIN, Milan NJK
2. DOLINGA, Dejan TAM
3. DRAGOJEVIĆ, Nemanja BAČ
3. JOVANOVIĆ, Nikola TUR
5. MENIČANIN, Radovan SLA
5. BLITVA, Vukašin NJK
7. SUDAR, Luka LOK
7. MILOVIĆ, Danilo NJK

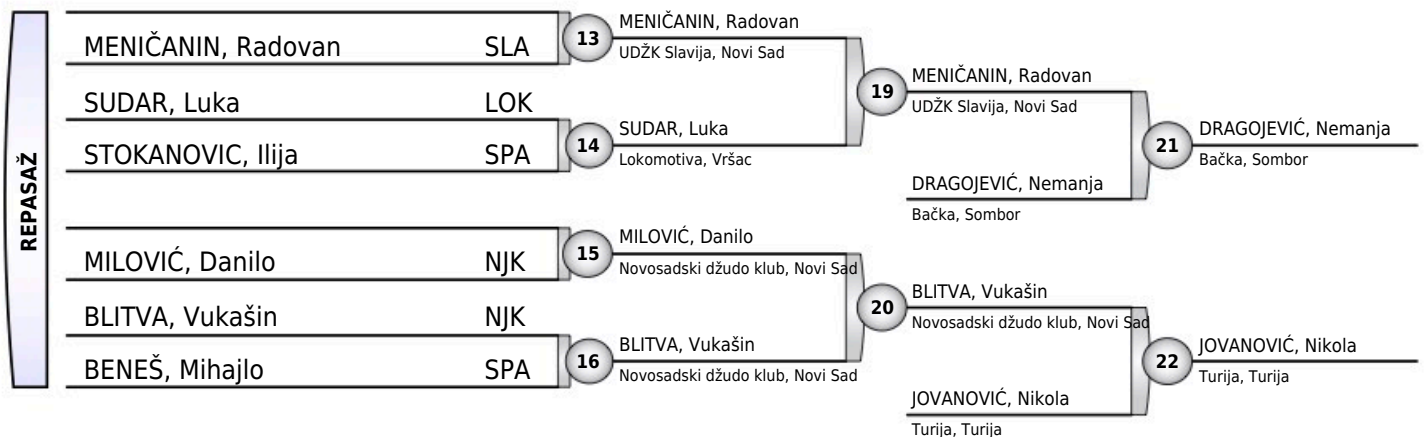



# REGIONALNO VOJVODINA S.DEČACI

Novi Sad, 15.05.2021.

STARIJI DEČACI

# -50KG

18 takmičara

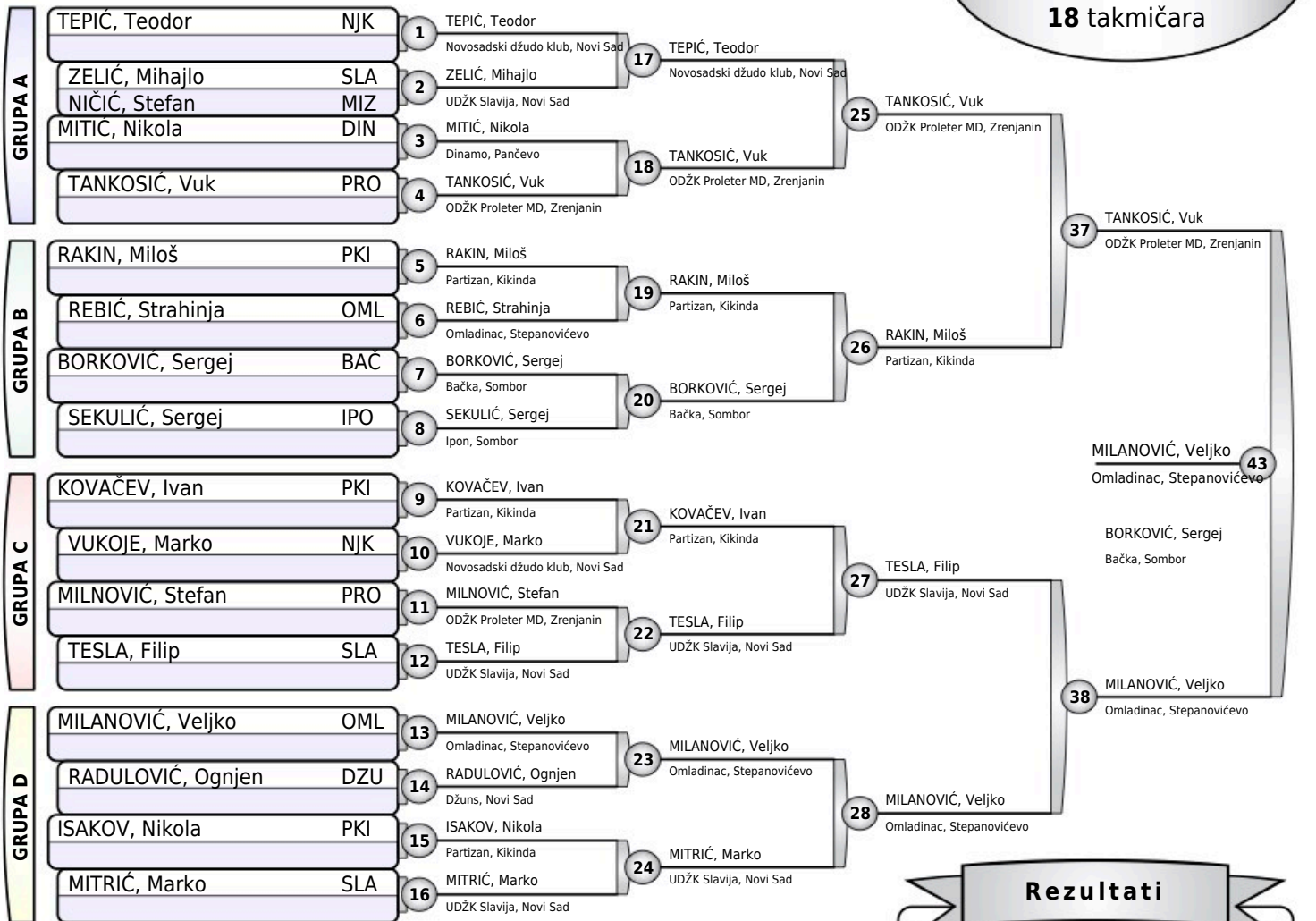

## Rezultati

- MILANOVIĆ, Veljko OML
- TANKOSIĆ, Vuk KOVAČEV, Ivan PRO
- TEPIĆ, Teodor Partizan, Kikinda NJK
- RAKIN, Miloš PKI
- TESLA, Filip SLA
- RADULOVIĆ, Ognjen DZU
- \* BORKOVIĆ, Sergej BAČ
- KOVAČEV, Ivan PKI

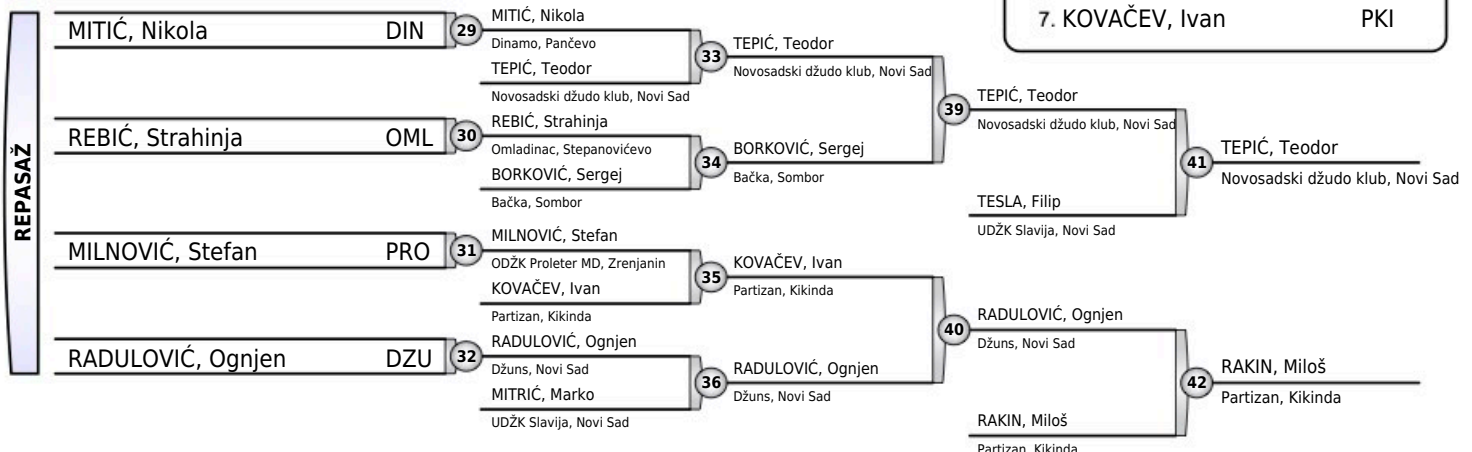





# REGIONALNO VOJVODINA S.DEČACI

Novi Sad, 15.05.2021.

STARIJI DEČACI

# -55KG

15 takmičara

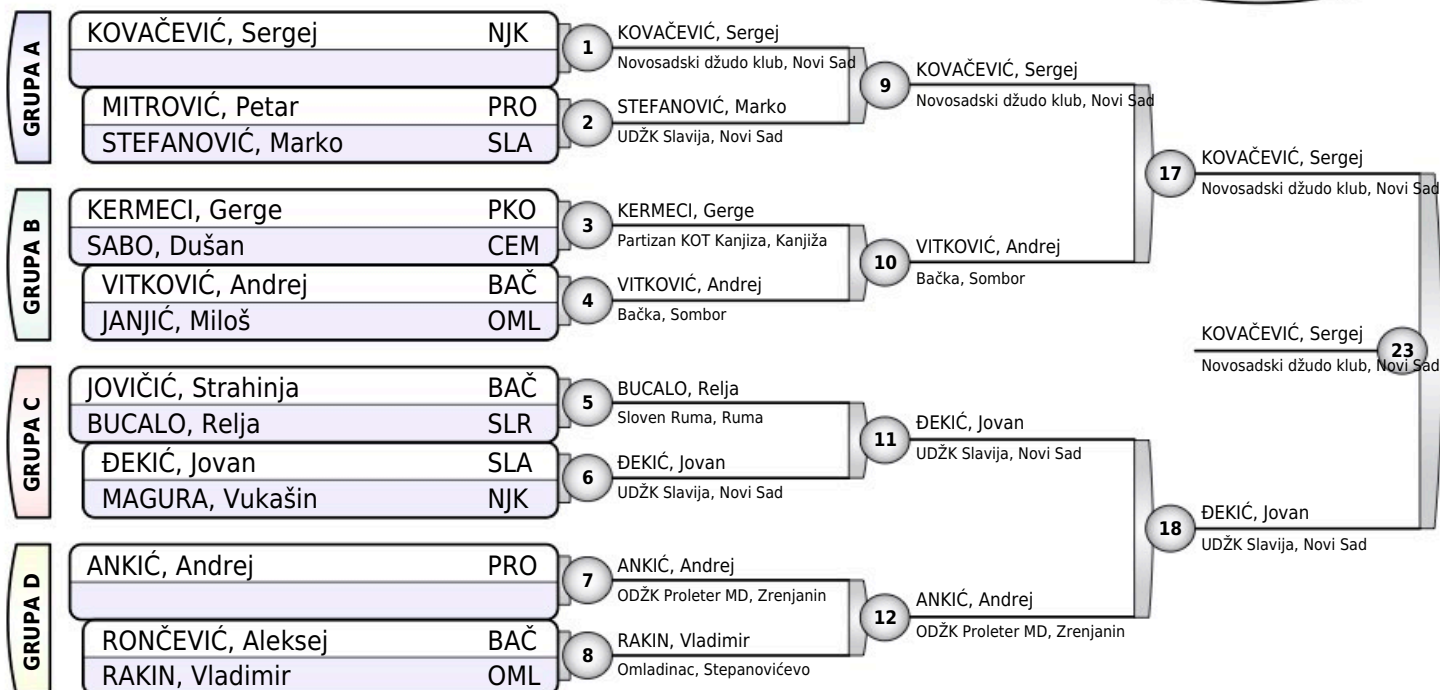

## Rezultati

1. KOVAČEVIĆ, Sergej NJK
2. ĐEKIĆ, Jovan SLA
3. STEFANOVIĆ, Marko SLA
3. VITKOVIĆ, Andrej BAČ
5. ANKIĆ, Andrej PRO
5. MAGURA, Vukašin NJK
7. JANJIĆ, Miloš OML
- \* 7. RAKIN, Vladimir OML

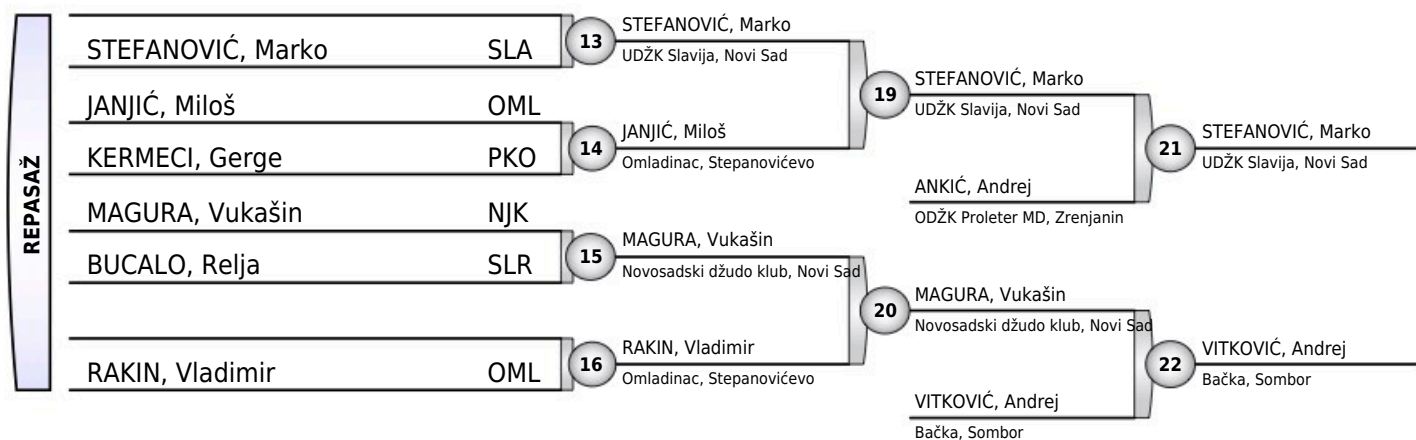



# REGIONALNO VOJVODINA S.DEČACI

Novi Sad, 15.05.2021.

STARIJI DEČACI

# -60KG

25 takmičara

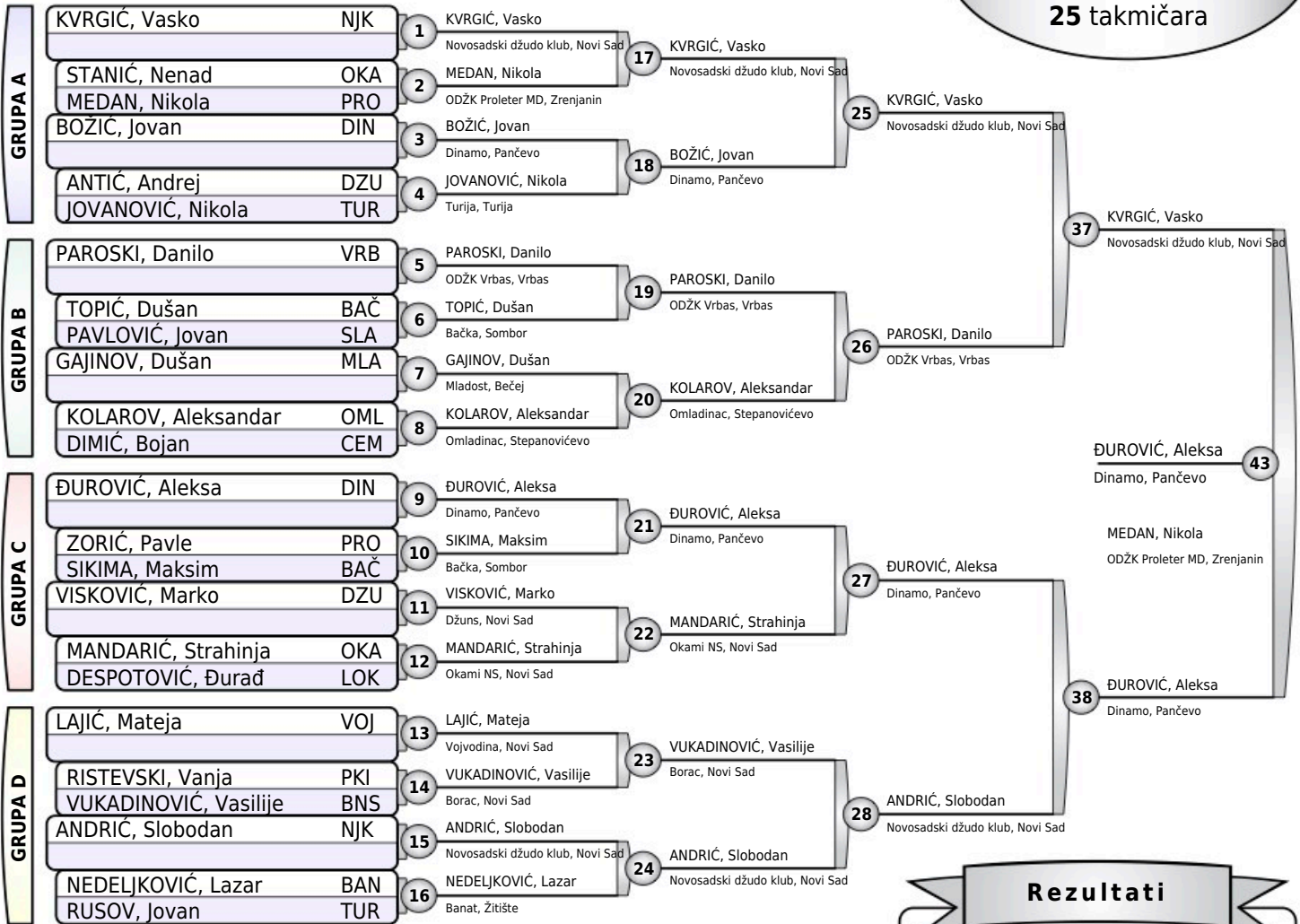

## Rezultati

- ĐUROVIĆ, Aleksa DIN
- KVRGIĆ, Vasko MANDARIĆ, Strahinja NJK
- ANDRIĆ, Slobodan Okami NS, Novi Sad NJK
- PAROSKI, Danilo VRB
- \* MEDAN, Nikola PRO
- MANDARIĆ, Strahinja OKA
- TOPIĆ, Dušan BAČ
- NEDELJKOVIĆ, Lazar BAN



# REGIONALNO VOJVODINA S.DEČACI

Novi Sad, 15.05.2021.

STARIJI DEČACI

# -66KG

15 takmičara

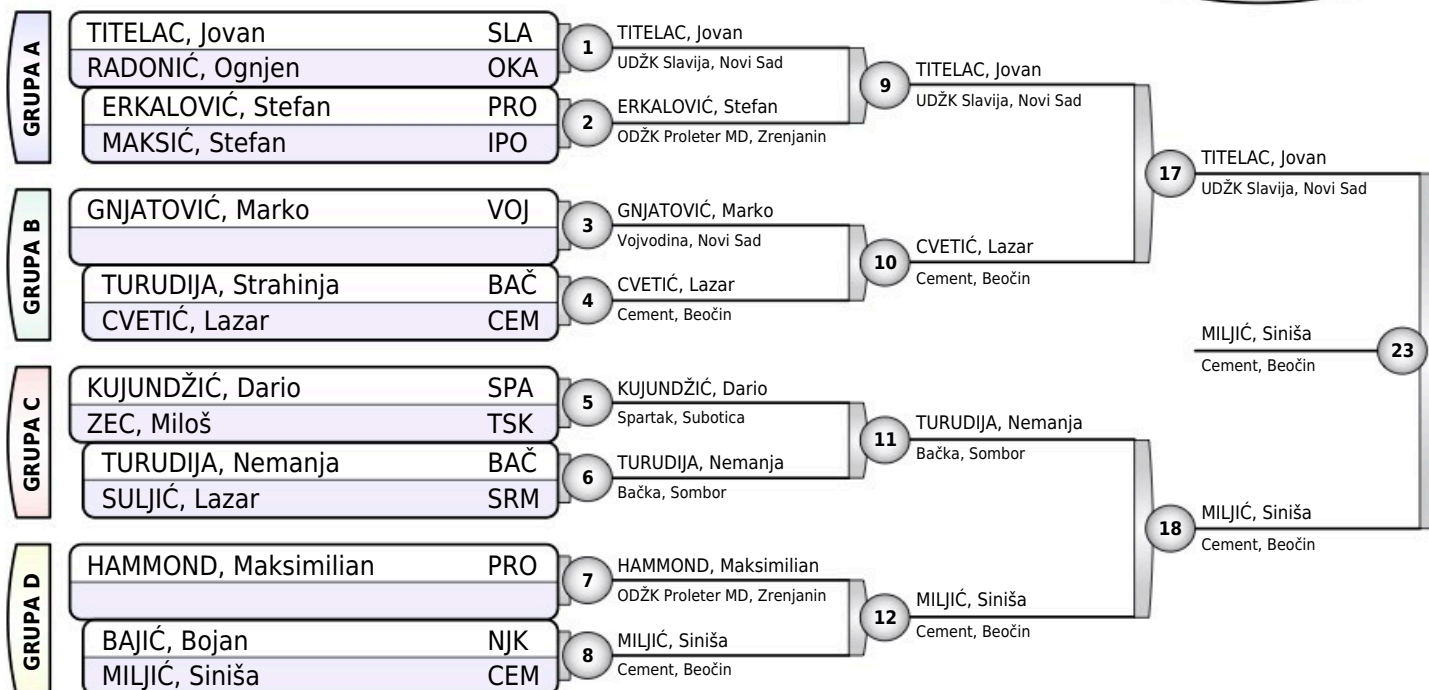

## Rezultati

- MILJIĆ, Siniša CEM
- TITELAC, Jovan SLA
- TURUDIJA, Nemanja BAČ
- BAJIĆ, Bojan NJK
- \* ERKALOVIĆ, Stefan PRO
- CVETIĆ, Lazar CEM
- GNJATOVIĆ, Marko VOJ
- KUJUNDŽIĆ, Dario SPA

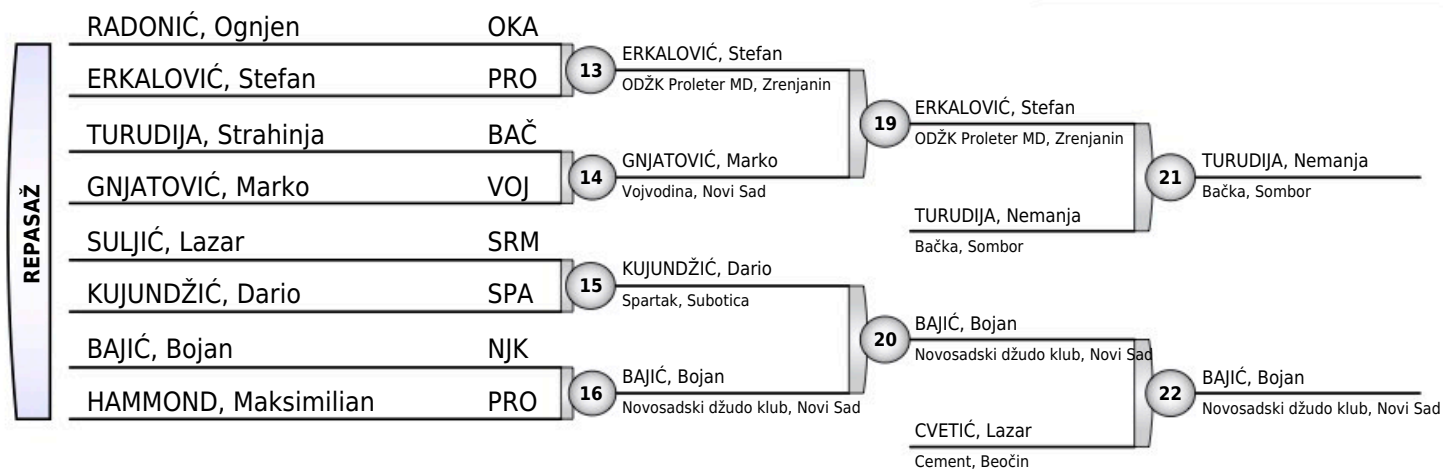





# REGIONALNO VOJVODINA S.DEČACI

Novi Sad, 15.05.2021.

STARIJI DEČACI

# -73KG

8 takmičara

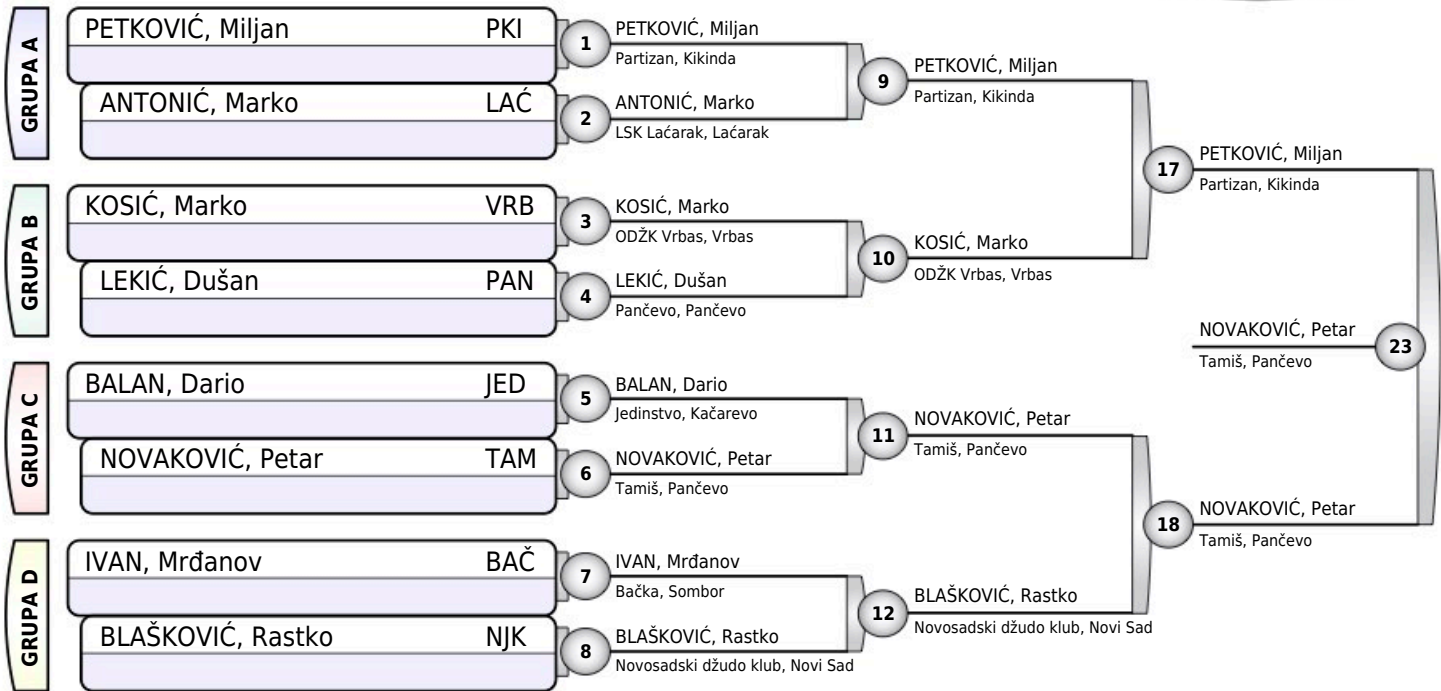

## Rezultati

- NOVAKOVIĆ, Petar TAM
- PETKOVIĆ, Miljan PKI
- BLAŠKOVIĆ, Rastko NJK
- BALAN, Dario JED
- ANTONIĆ, Marko LAĆ
- KOSIĆ, Marko VRB
- LEKIĆ, Dušan PAN
- IVAN, Mrđanov BAČ

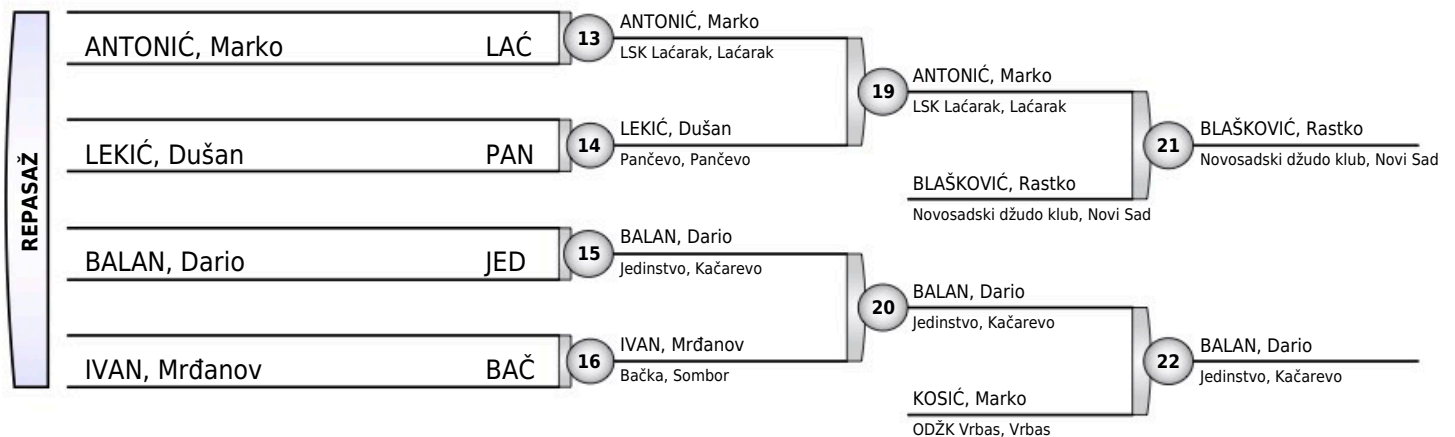



# REGIONALNO VOJVODINA S.DEČACI

Novi Sad, 15.05.2021.

STARIJI DEČACI

# +73KG

13 takmičara

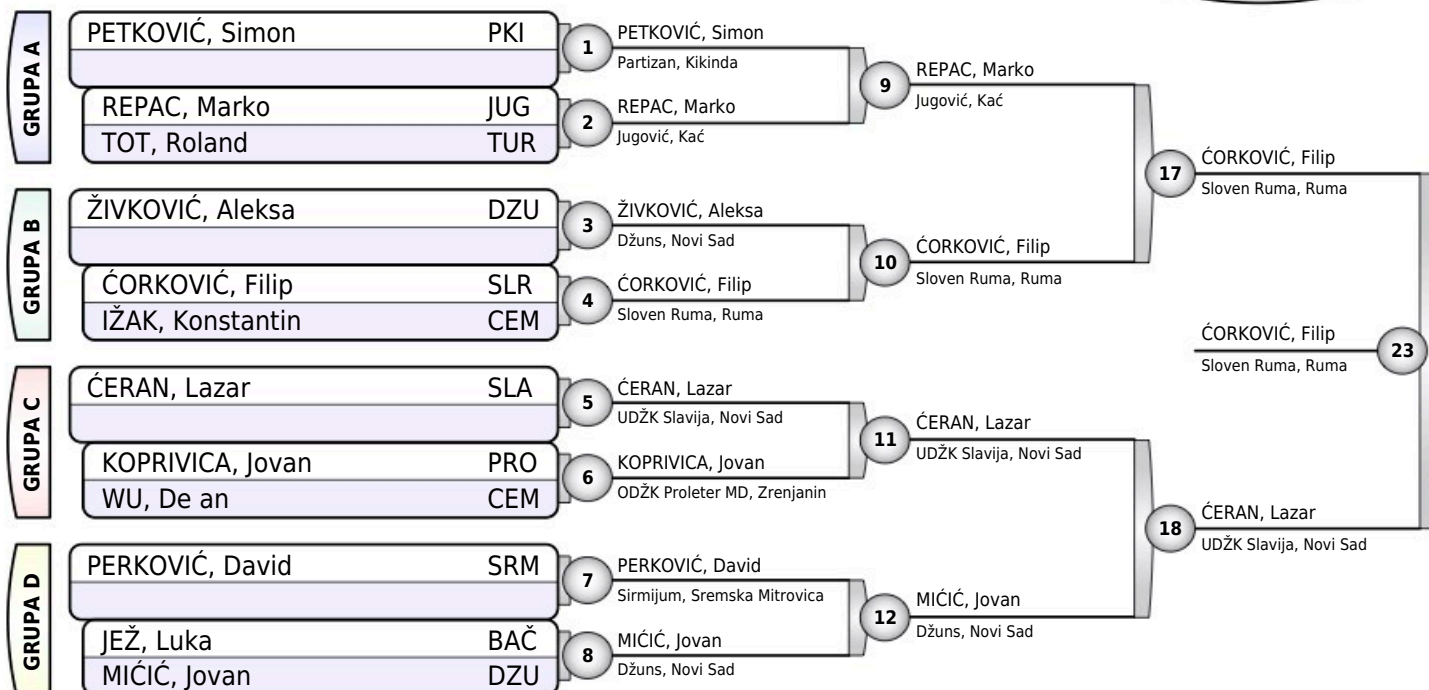

## Rezultati

1. ČORKOVIĆ, Filip SLR
2. ČERAN, Lazar SLA
3. MIČIĆ, Jovan DZU
3. PERKOVIĆ, David SRM
5. PETKOVIĆ, Simon PKI
5. REPAC, Marko JUG
- \* 7. ŽIVKOVIĆ, Aleksa DZU
7. KOPRIVICA, Jovan PRO

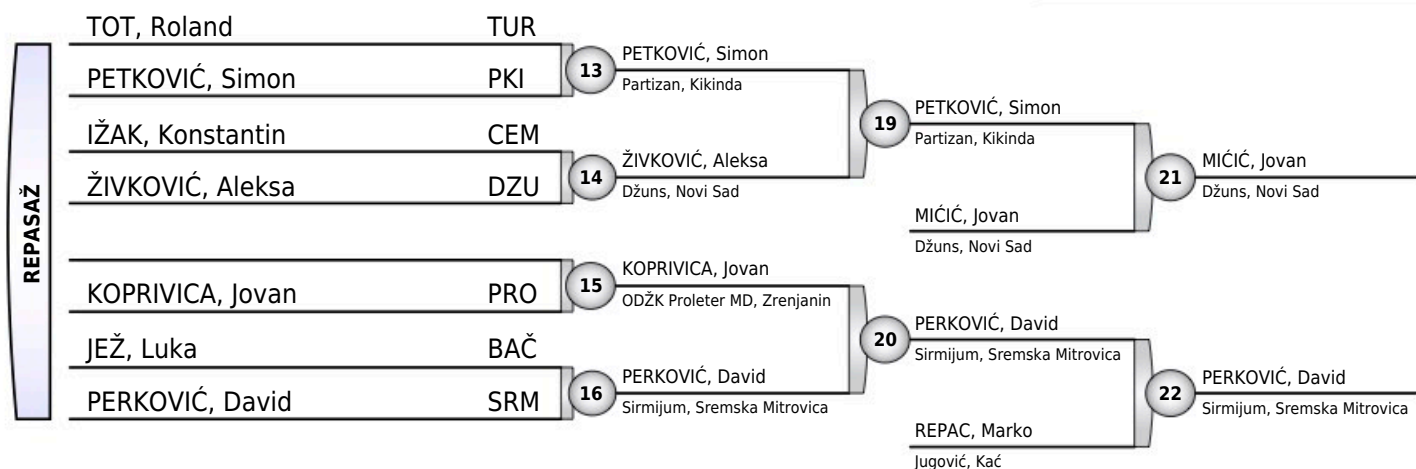



# REGIONALNO VOJVODINA S.DEČACI

Novi Sad, 15.05.2021.

STARIJE DEVOJČICE

# -36KG

2 takmičarke

VRČINAC, Milica	BNS	1	VRČINAC, Milana Borac, Novi Sad
VRČINAC, Milana	BNS		
VRČINAC, Milica	BNS	2	VRČINAC, Milana Borac, Novi Sad
VRČINAC, Milana	BNS		
		3	

## Rezultati

1. VRČINAC, Milana BNS
2. VRČINAC, Milica BNS



# REGIONALNO VOJVODINA S.DEČACI

Novi Sad, 15.05.2021.

STARIJE DEVOJČICE

# -40KG

1 takmičarka

PROLIĆ, Natalija

CEM

1

PROLIĆ, Natalija

Cement, Beočin

## Rezultati

1. PROLIĆ, Natalija

CEM



# REGIONALNO VOJVODINA S.DEČACI

Novi Sad, 15.05.2021.

STARIJE DEVOJČICE

# -44KG

5 takmičarki

TAKMIČAR I KLUB	1	2	3	4	5	POBEDA	BODOVA	MESTO
1 ŠTAJNFELD, Sara Sportsko udruženje "Mija&Zorka", Subotica		10	10	1	0	3	21	2
2 JURLINA, Lenka Vojvodina, Novi Sad	0		0	0	0	0	0	5
3 KUŠIĆ, Milana Partizan, Novi Sad	0	10		0	0	1	10	3
4 HERŠČAK, Andreja Partizan, Novi Sad	0	10	10		0	2	20	3
5 PEJNOVIĆ, Jana Jedinstvo, Kačarevo	10	10	10	10		4	40	1

ŠTAJNFELD, Sara	MIZ	1	ŠTAJNFELD, Sara
JURLINA, Lenka	VOJ		Sportsko udruženje "Mija&Zorka", Subotica
KUŠIĆ, Milana	PNS	2	HERŠČAK, Andreja
HERŠČAK, Andreja	PNS		Partizan, Novi Sad
ŠTAJNFELD, Sara	MIZ	3	PEJNOVIĆ, Jana
PEJNOVIĆ, Jana	JED		Jedinstvo, Kačarevo
JURLINA, Lenka	VOJ	4	KUŠIĆ, Milana
KUŠIĆ, Milana	PNS		Partizan, Novi Sad
HERŠČAK, Andreja	PNS	5	PEJNOVIĆ, Jana
PEJNOVIĆ, Jana	JED		Jedinstvo, Kačarevo
ŠTAJNFELD, Sara	MIZ	6	ŠTAJNFELD, Sara
KUŠIĆ, Milana	PNS		Sportsko udruženje "Mija&Zorka", Subotica
JURLINA, Lenka	VOJ	7	HERŠČAK, Andreja
HERŠČAK, Andreja	PNS		Partizan, Novi Sad
KUŠIĆ, Milana	PNS	8	PEJNOVIĆ, Jana
PEJNOVIĆ, Jana	JED		Jedinstvo, Kačarevo
ŠTAJNFELD, Sara	MIZ	9	ŠTAJNFELD, Sara
HERŠČAK, Andreja	PNS		Sportsko udruženje "Mija&Zorka", Subotica
JURLINA, Lenka	VOJ	10	PEJNOVIĆ, Jana
PEJNOVIĆ, Jana	JED		Jedinstvo, Kačarevo

## Rezultati

- |                     |     |
|---------------------|-----|
| 1. PEJNOVIĆ, Jana   | JED |
| 2. ŠTAJNFELD, Sara  | MIZ |
| 3. HERŠČAK, Andreja | PNS |
| 3. KUŠIĆ, Milana    | PNS |
| 5. JURLINA, Lenka   | VOJ |





# REGIONALNO VOJVODINA S.DEČACI

Novi Sad, 15.05.2021.

STARIJE DEVOJČICE

## -48KG

8 takmičarki

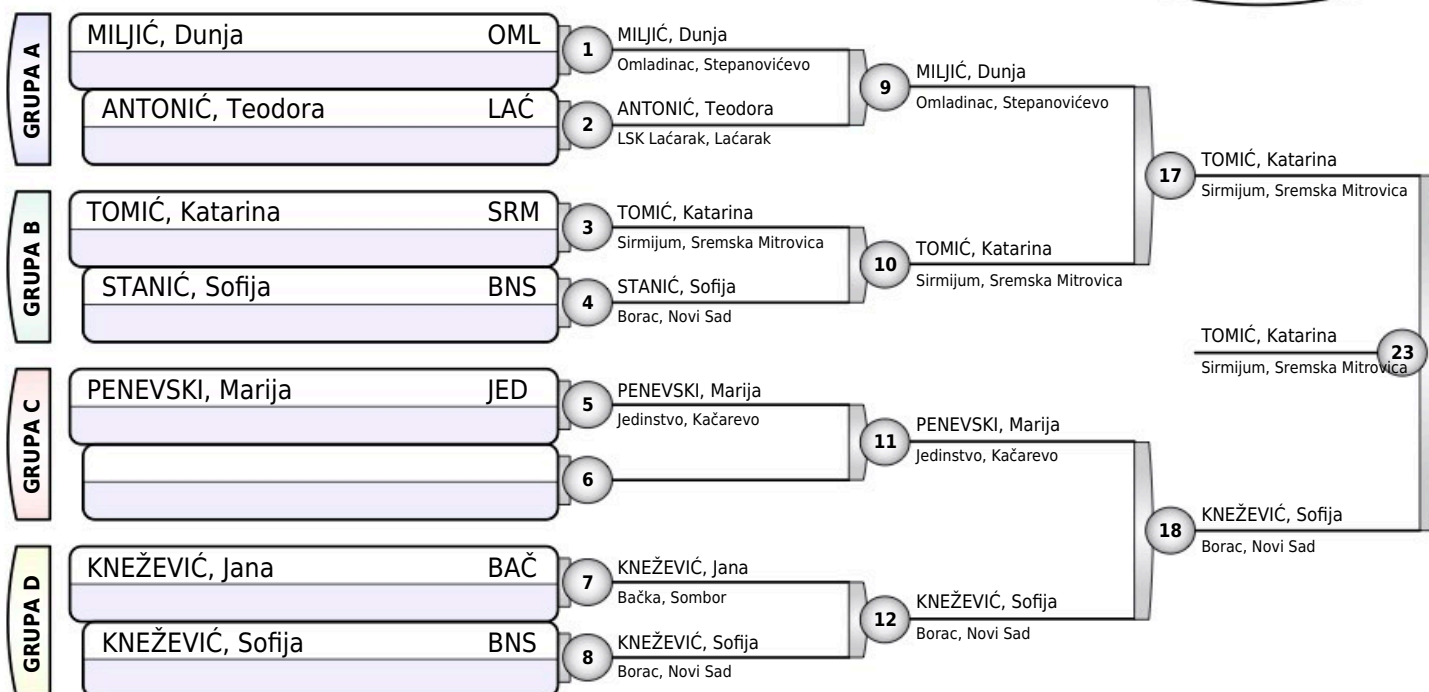

### Rezultati

1. TOMIĆ, Katarina SRM
2. KNEŽEVIĆ, Sofija BNS
3. ANTONIĆ, Teodora LAĆ
3. MILJIĆ, Dunja OML
5. PENEVSKI, Marija JED
- \* 5. KNEŽEVIĆ, Jana BAČ
7. STANIĆ, Sofija BNS
- 7.

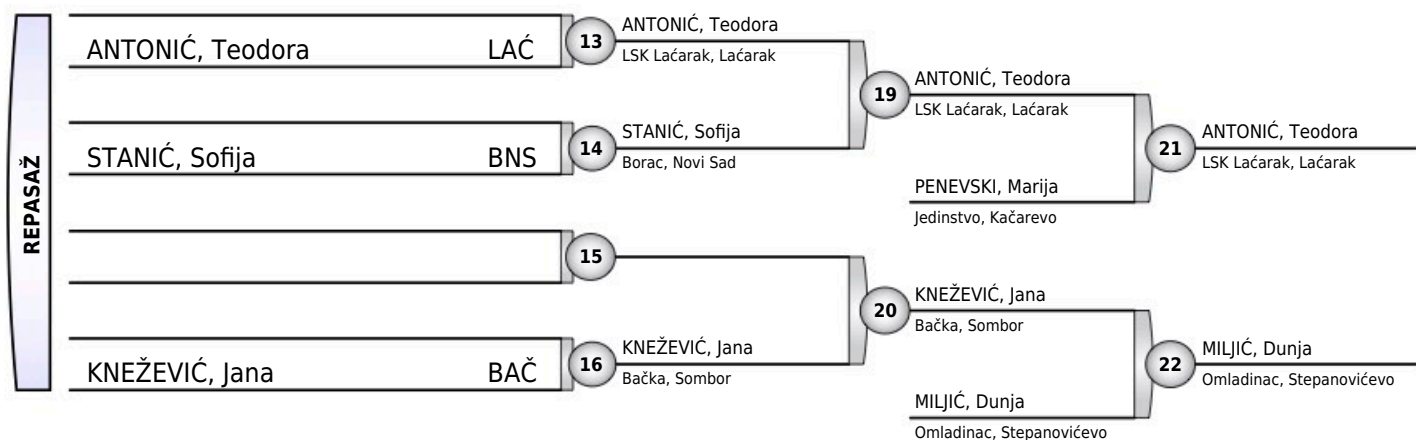



# REGIONALNO VOJVODINA S.DEČACI

Novi Sad, 15.05.2021.

STARIJE DEVOJČICE

# -52KG

11 takmičarki

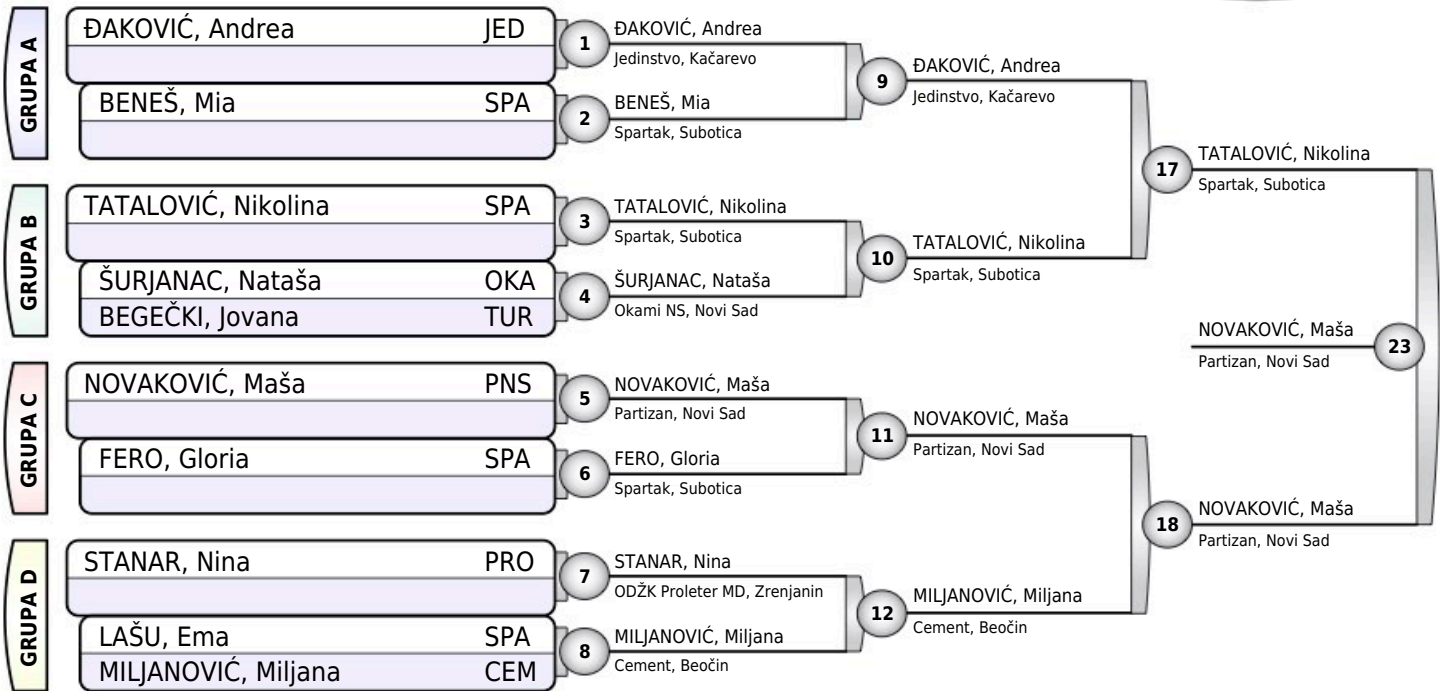

## Rezultati

- NOVAKOVIĆ, Maša (PNS)
- TATALOVIĆ, Nikolina (SPA)
- ŠURJANAC, Nataša (OKA)
- ĐAKOVIĆ, Andrea (JED)
- \* MILJANOVIĆ, Miljana (CEM)
- FERRO, Gloria (SPA)
- BENEŠ, Mia (SPA)
- STANAR, Nina (PRO)

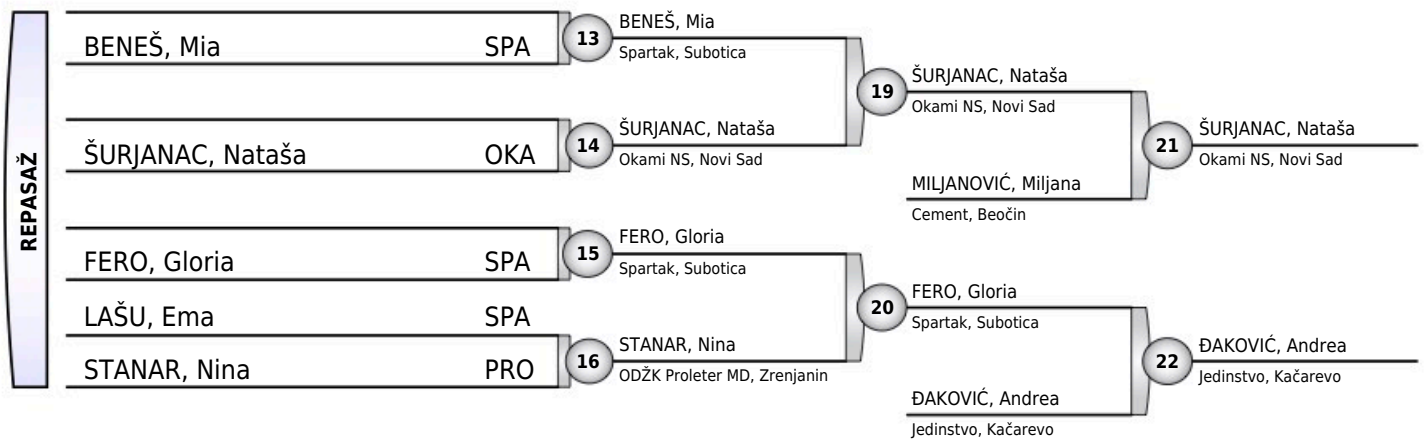



# REGIONALNO VOJVODINA S.DEČACI

Novi Sad, 15.05.2021.

STARIJE DEVOJČICE

# -57KG

11 takmičarki

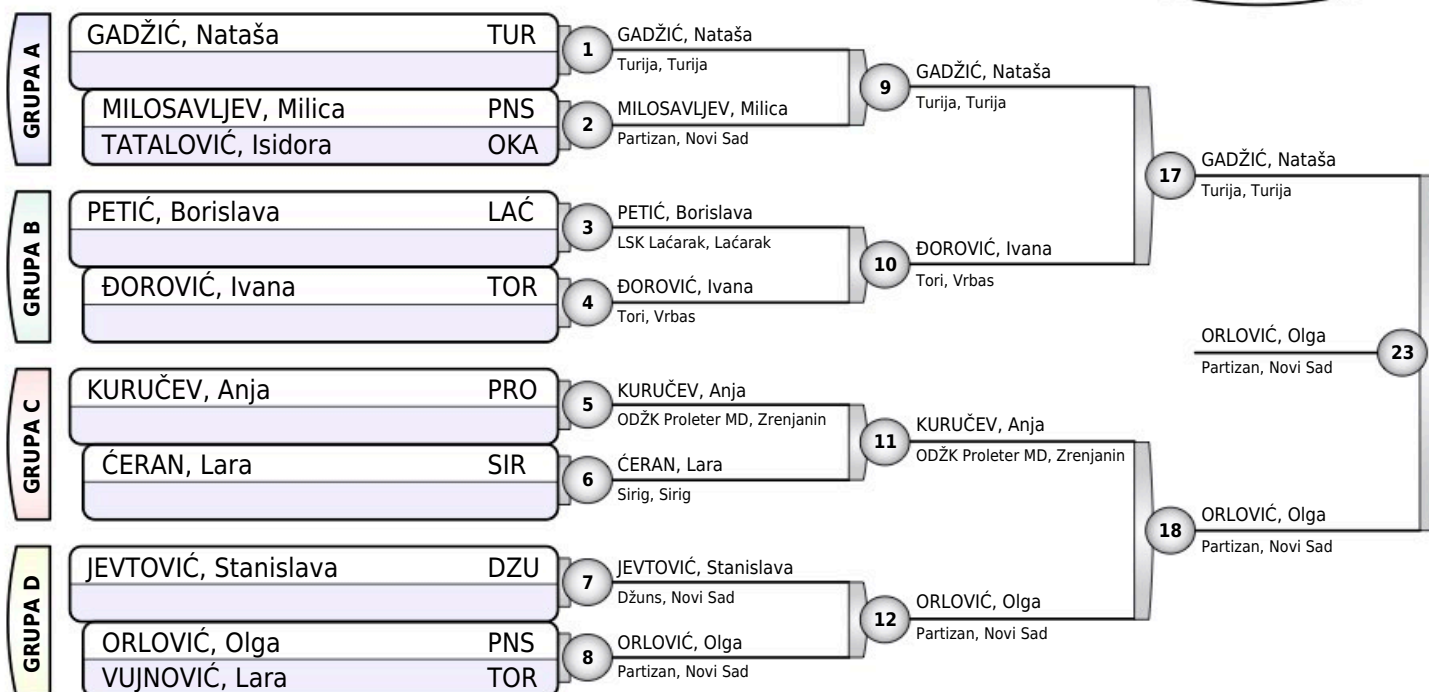

## Rezultati

- ORLOVIĆ, Olga (PNS)
- GADŽIĆ, Nataša (TUR)
- MILOSAVLJEV, Milica (PNS)
- JEVTIČIĆ, Stanislava (DZU)
- \* KURUČEV, Anja (PRO)
- ĐOROVIĆ, Ivana (TOR)
- PETIĆ, Borislava (LAĆ)
- ČERAN, Lara (SIR)

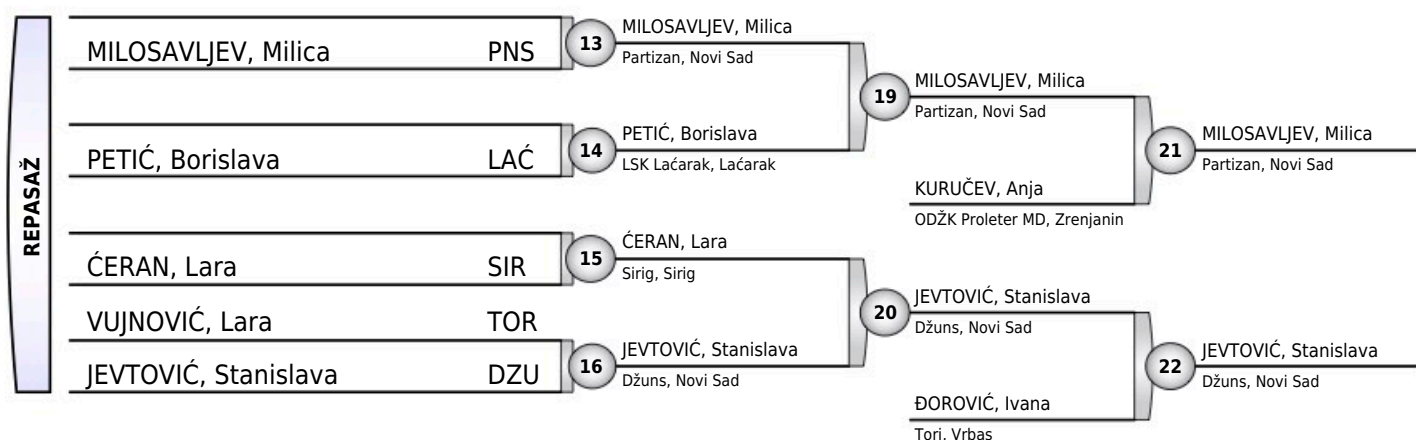



# REGIONALNO VOJVODINA S.DEČACI

Novi Sad, 15.05.2021.

STARIJE DEVOJČICE

## -63KG

8 takmičarki

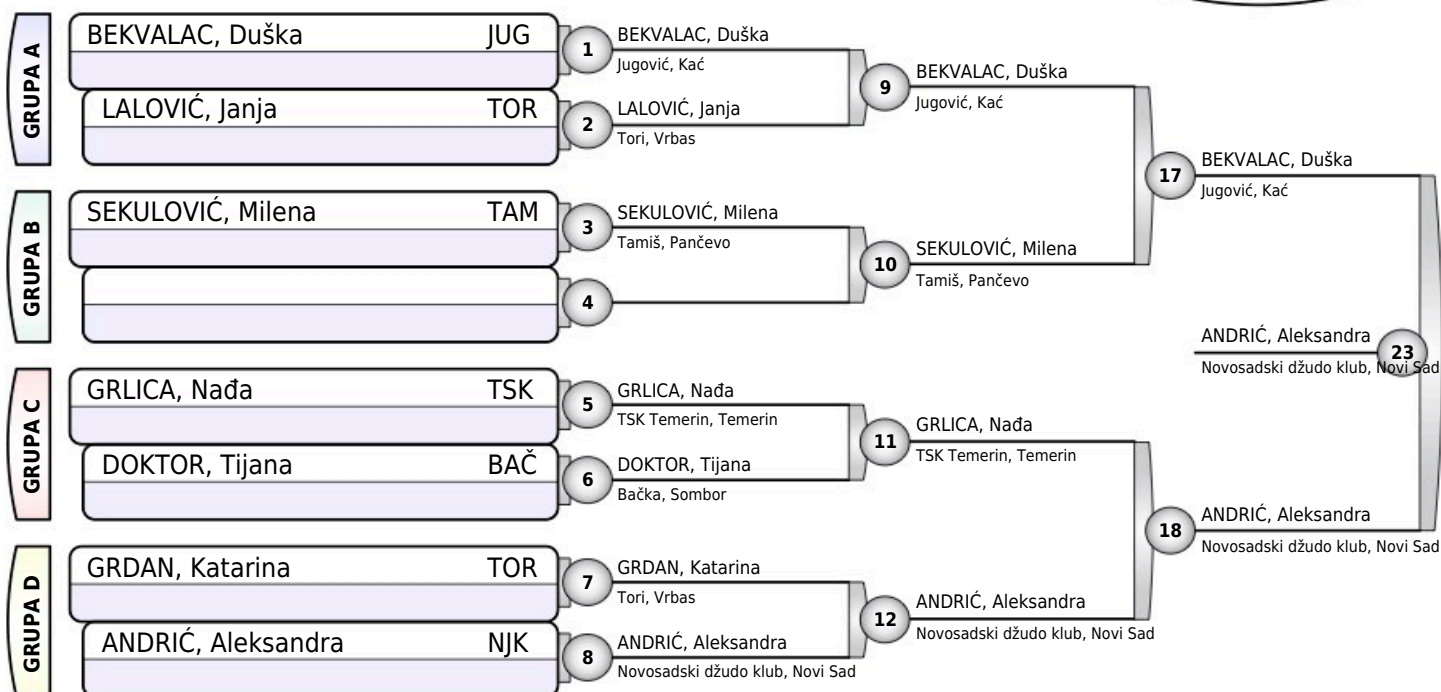

### Rezultati

- ANDRIĆ, Aleksandra NJK
- BEKVALAC, Duška JUG
- GRLICA, Nađa TSK
- SEKULOVIĆ, Milena TAM
- LALOVIĆ, Janja TOR
- GRDAN, Katarina TOR
- DOKTOR, Tijana BAČ
- 

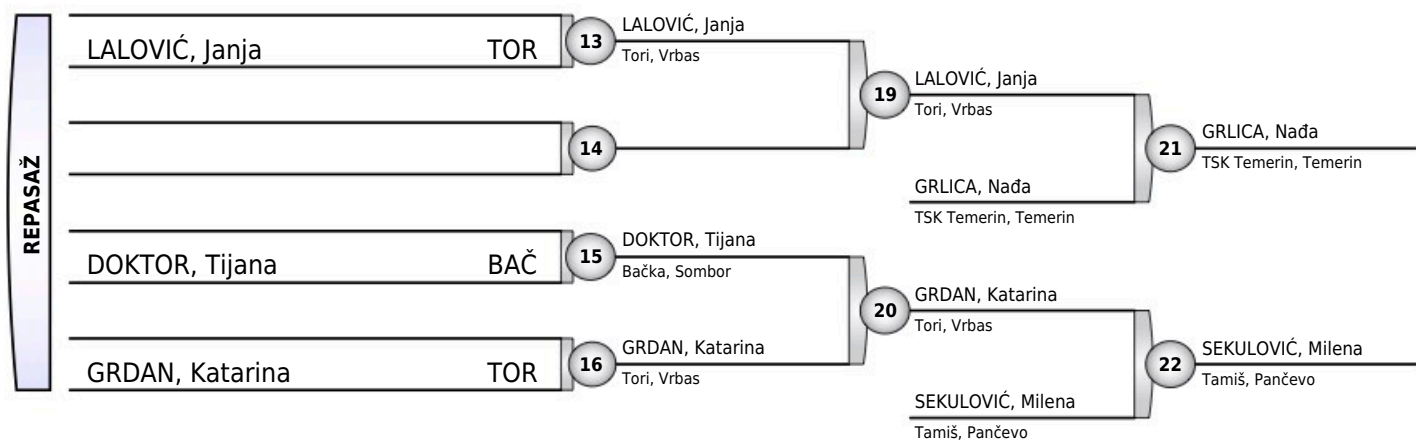



# REGIONALNO VOJVODINA S.DEČACI

Novi Sad, 15.05.2021.

STARIJE DEVOJČICE

## +63KG

10 takmičarki

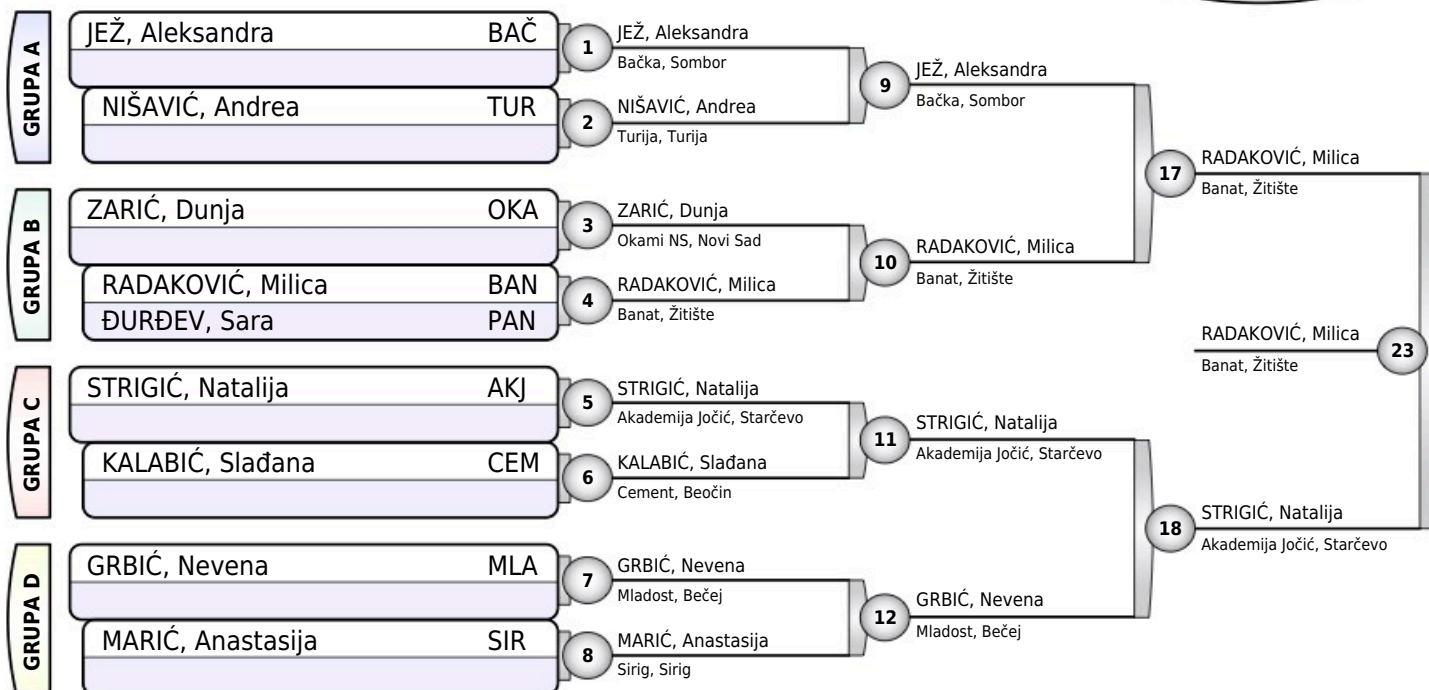

### Rezultati

1. RADAKOVIĆ, Milica BAN
2. STRIGIĆ, Natalija AKJ
3. ZARIĆ, Dunja OKA
3. JEŽ, Aleksandra BAČ
- \* 5. GRBIĆ, Nevena MLA
5. MARIĆ, Anastasija SIR
7. NIŠAVIĆ, Andrea TUR
7. KALABIĆ, Slađana CEM

